

Manufacturer & Exporter of Surgical, Dental & Orthopedic Instruments

## SURGICAL CATALOGUE

[WWW.MABSONORTHO.COM](http://WWW.MABSONORTHO.COM)



Tel: +92 52 3570603

Fax: +92 52 3570604

Moh. Islamabad Union Council  
Near Imran Market Ugoki Morre,  
Sialkot-51310 Pakistan



Allgemeines Instrumentarium . General Instrumentation . Instrumental general

Anatomische Skalpelle  
Dissecting Knives  
Bisturios para disección  
Bistouris à dissection  
Bisturi per dissezione



MAB01-001 MAB01-002 MAB01-003 MAB01-004 MAB01-005  
Fig. 1 15 cm / 6" Fig. 2 15 cm / 6" Fig. 3 15.5 cm / 6" Fig. 4 16 cm / 6 1/4" Fig. 5 16 cm / 6 1/4"  
30 mm 36 mm 40 mm 45 mm 50 mm

mit Metallheft  
with metal handel  
con mango metálico  
avec manche en métal  
con manico di metallo

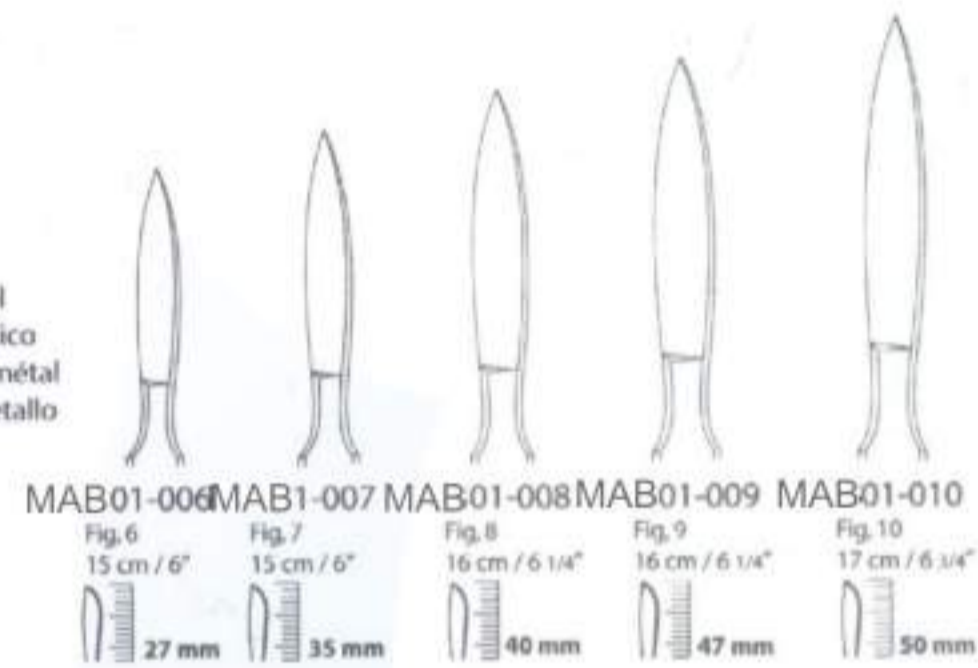

MAB01-006 MAB01-007 MAB01-008 MAB01-009 MAB01-010  
Fig. 6 15 cm / 6" Fig. 7 15 cm / 6" Fig. 8 16 cm / 6 1/4" Fig. 9 16 cm / 6 1/4" Fig. 10 17 cm / 6 1/4"  
27 mm 35 mm 40 mm 47 mm 50 mm

Allgemeines Instrumentarium . Instrumentation générale . Strumentario generale

Seziernmesser , Knorpelmesser , Organmesser  
Autopsy Knives, Cartilage Knives, Post Mortem Knives  
Cuchillos para autopsia, Cuchillos para cartilago, Cuchillos para órganos  
Cousteaux à dissection, Cousteaux à cartilage, Cousteaux à autopsie  
Coltelli per autopsia, Coltelli per cartilagini

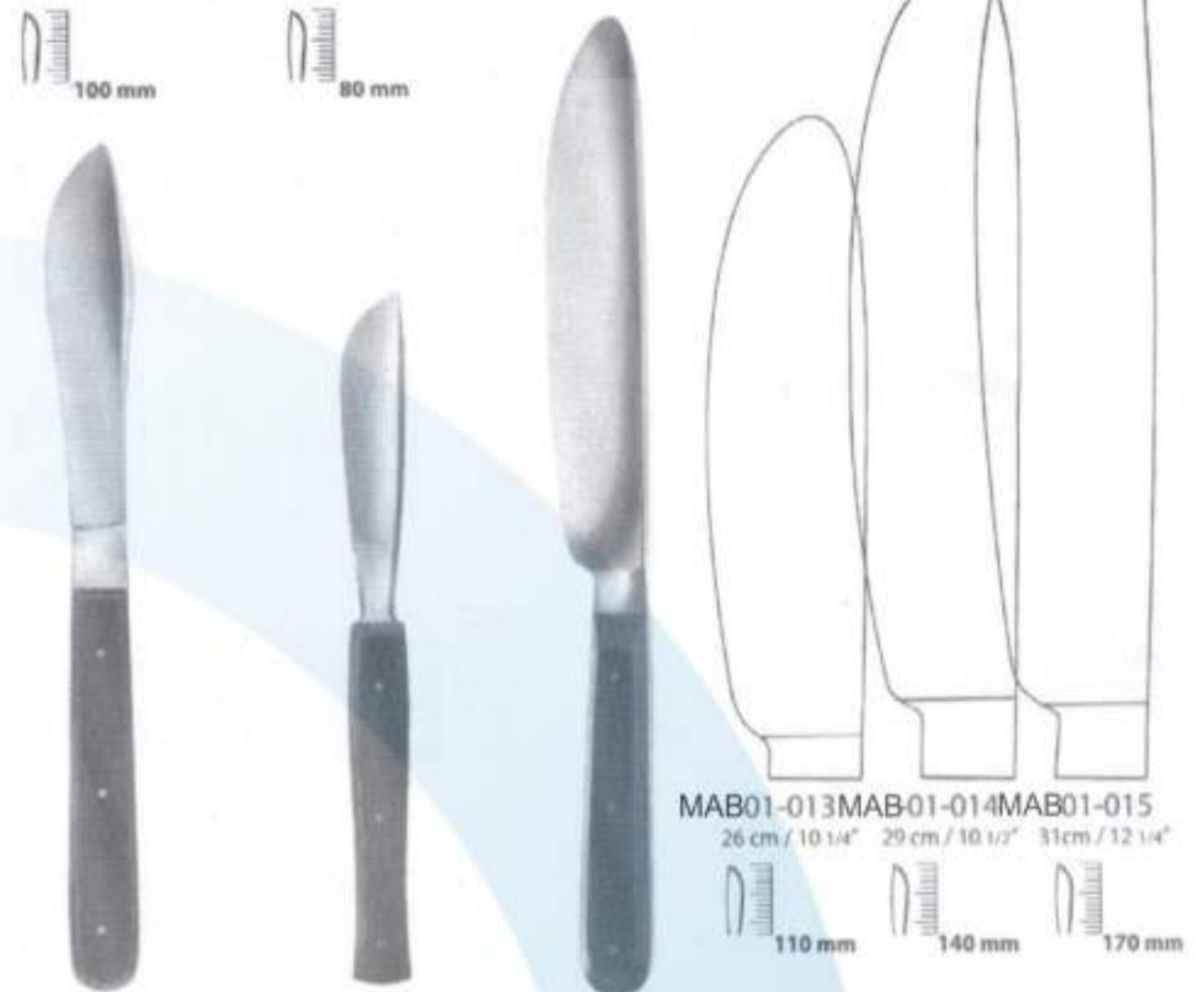

MAB01-011 25,5 cm / 10" mit Holzheft with wooden handle con mango de madera avec manche en bois con manico di legno  
MAB01-012 21 cm / 8 1/4" mit Holzheft with wooden handle con mango de madera avec manche en bois con manico di legno  
Walb mit Holzheft with wooden handle con mango de madera avec manche en bois con manico di legno  
MAB01-013 26 cm / 10 1/4" MAB01-014 29 cm / 10 1/2" MAB01-015 31 cm / 12 1/4"  
110 mm 140 mm 170 mm

Allgemeines Instrumentarium . General Instrumentation . Instrumental general

Hirnmesser  
Brain Knives  
Cuchillos para cerebro  
Cousteaux à cerveau  
Coltelli per il cervello

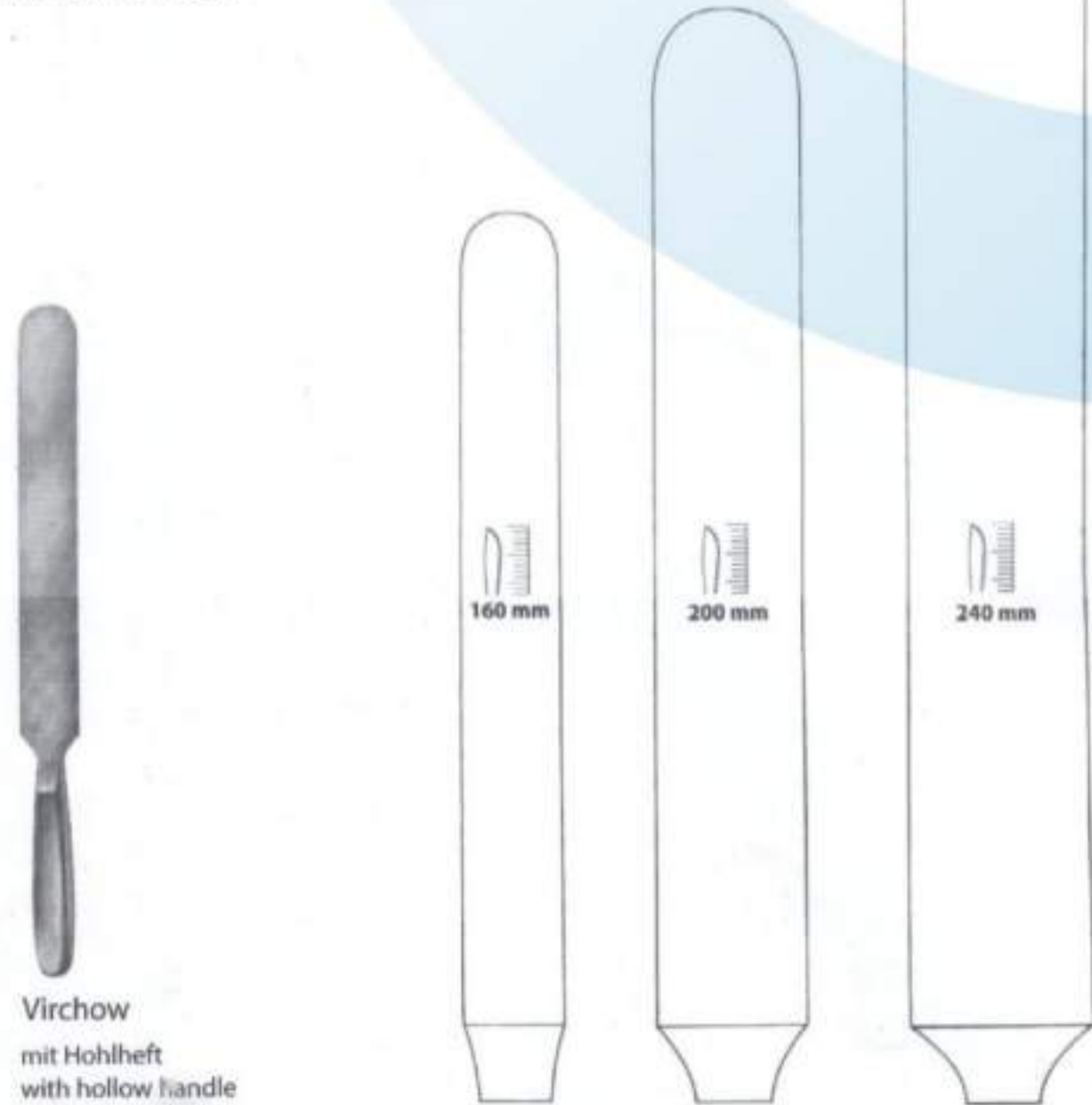

MAB01-016 26 cm / 10 1/4" MAB01-017 33.5 cm / 13 1/4" MAB01-018 38 cm / 15"

Virchow  
mit Hohlheft  
with hollow handle  
con mango hueco  
avec manche creux  
con manico incavato

Allgemeines Instrumentarium . Instrumentation générale . Strumentario generale

Klingenhalter / Klingenbrecher  
Blade Holders / Blade Breakers  
Porta-hojas / Rompe-hojas de afeitar  
Pincettes pour saisir et casser les lames de rasoir  
Pinze per afferrare e rompere le lamette da rasoio

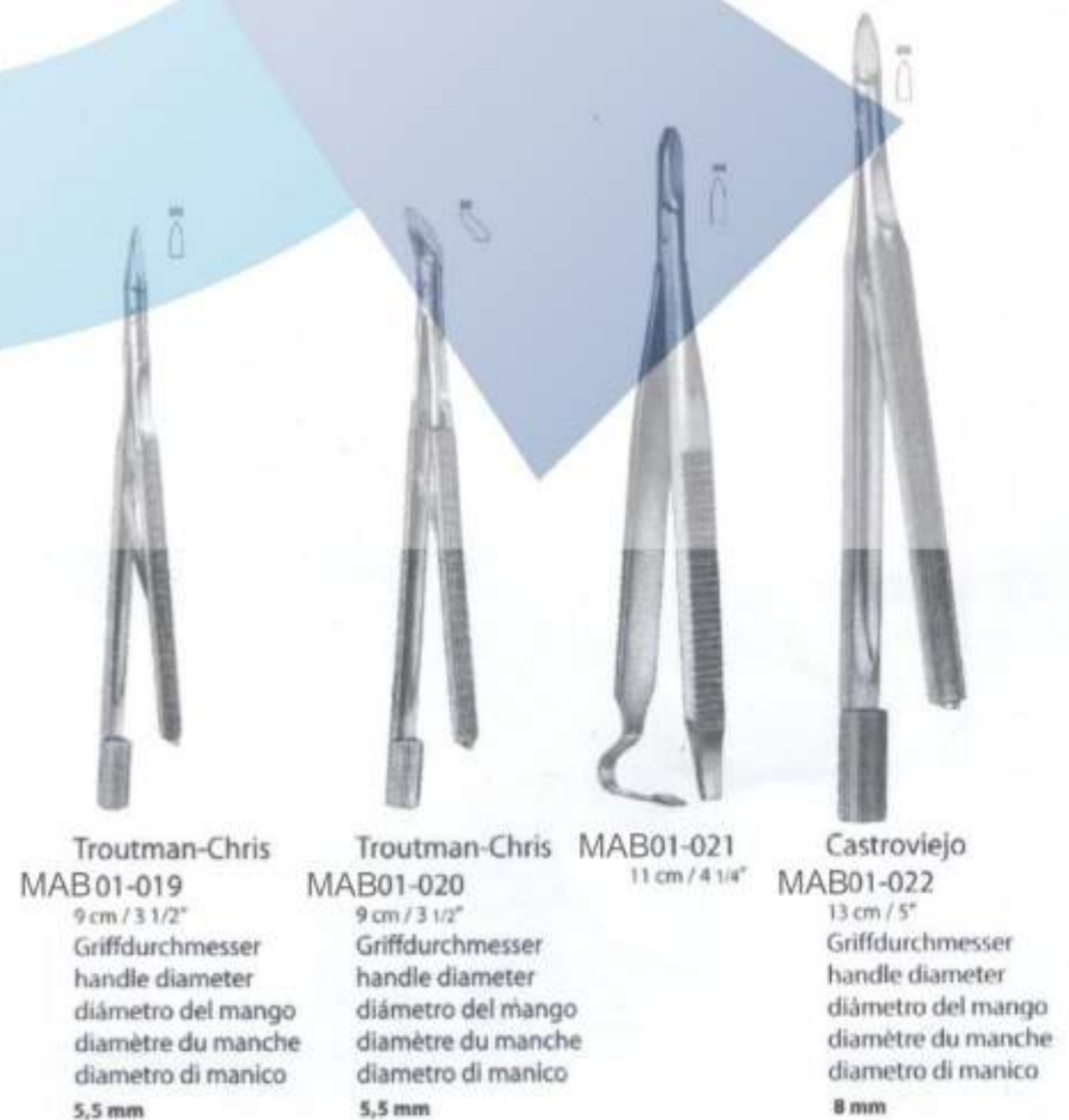

Troutman-Chris MAB01-019 9 cm / 3 1/2" Griffdurchmesser handle diameter diámetro del mango diamètre du manche diametro di manico 5,5 mm  
Troutman-Chris MAB01-020 9 cm / 3 1/2" Griffdurchmesser handle diameter diámetro del mango diamètre du manche diametro di manico 5,5 mm  
MAB01-021 11 cm / 4 1/4"  
Castroviejo MAB01-022 13 cm / 5" Griffdurchmesser handle diameter diámetro del mango diamètre du manche diametro di manico 8 mm



Allgemeines Instrumentarium . General Instrumentation . Instrumental general  
 Skalpellgriffe  
 Scalpel Handles  
 Mangos de bisturi  
 Manches pour bistouris  
 Manici per bisturi

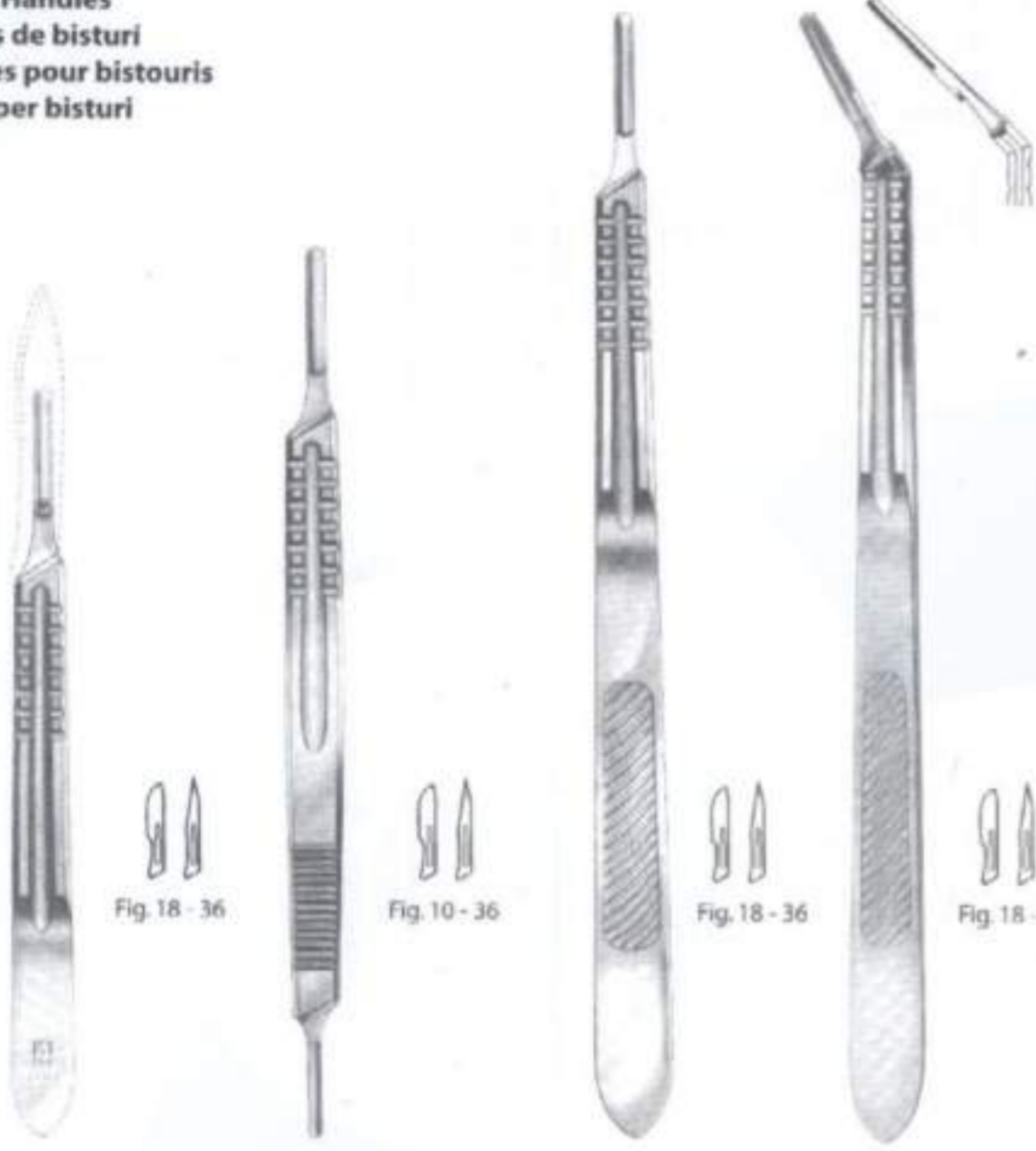

**MAB01-023**  
 13.5 cm / 5 1/4"  
 No. 4  
 massiv  
 solid  
 macizo  
 solide  
 pieno

**MAB01-024**  
 16 cm / 6 1/4"  
 No. 3 & 4  
 massiv, doppelending  
 solid, double-ended  
 macizo, doble extremo  
 solide, double  
 pieno, doppio

**MAB01-025**  
 21 cm / 8 1/4"  
 No. 4L  
 massiv, lang  
 solid, long  
 macizo, largo  
 solide, long  
 pieno, lungo

**MAB01-026**  
 21 cm / 8 1/4"  
 No. 4L  
 massive, abgewinkelt, lang  
 solid, angled, long  
 macizo, angulado, largo  
 solide, coudé, long  
 pieno, angolare, lungo

Allgemeines Instrumentarium . Instrumentation générale . Strumentario generale  
 Skalpellgriffe  
 Scalpel Handles  
 Mangos de bisturi  
 Manches pour bistouris  
 Manici per bisturi



**MAB01-027**  
 No. 8  
 13.5 cm / 5 1/4"  
 mit Hohlheft  
 with hollow handle  
 con mango hueco  
 avec manche creux  
 con manico vuoto

**MAB01-028**  
 No. 9  
 14.5 cm / 5 3/4"  
 mit Hohlheft  
 with hollow handle  
 con mango hueco  
 avec manche creux  
 con manico vuoto

**MAB01-029**  
 No. 4  
 13.5 cm / 5 1/4"  
 mit Kunststoffheft  
 with plastic handle  
 con mango plástico  
 avec manche en matière plastique  
 con manico di materia plastica

Allgemeines Instrumentarium . General Instrumentation . Instrumental general  
 Skalpellgriffe  
 Scalpel Handles  
 Mangos de bisturi  
 Manches pour bistouris  
 Manici per bisturi

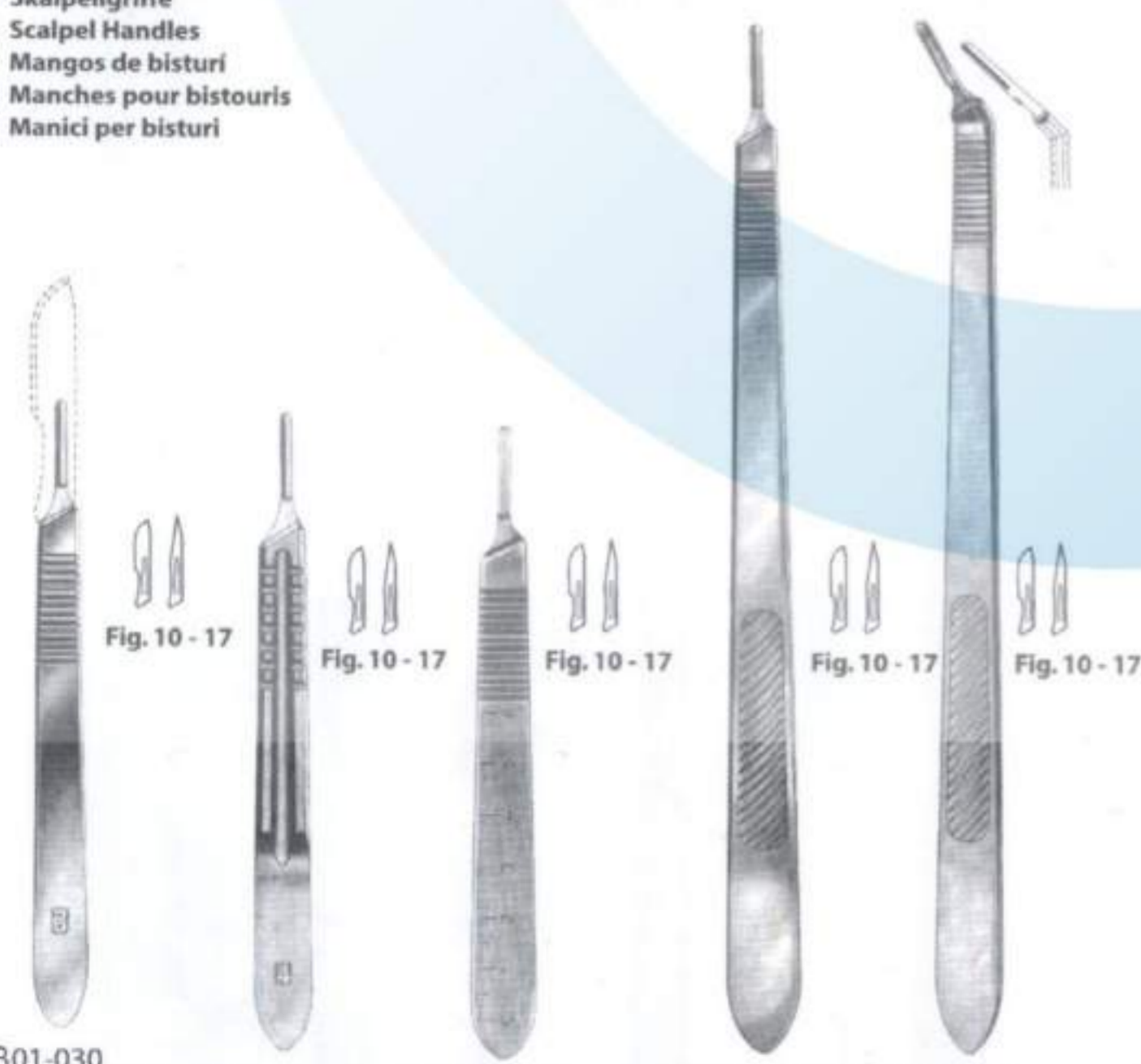

**MAB01-030**  
 No. 3  
 12 cm / 4 3/4"  
 massive  
 solid  
 macizo  
 solide  
 pieno

**MAB01-031**  
 No. 3  
 12 cm / 4 3/4"  
 massive, Heftprofil wie  
 Griff No. 4  
 solid, handle style as no. 4  
 macizo, mango como no. 4  
 solide, manche selon no. 4  
 pieno, manico come no. 4

**MAB01-032**  
 No. 3  
 12 cm / 4 3/4"  
 massiv, mit Zentimeter-  
 Graduierung  
 solid, cm-graduation  
 macizo, graduado en cm  
 solide, gradué en cm  
 pieno, graduato in cm

**MAB01-033**  
 No. 3L  
 21.5 cm / 8 1/2"  
 massive, lang  
 solid, long  
 macizo, largo  
 solide, long  
 pieno, lungo

**MAB01-034**  
 No. 3L  
 21 cm / 8 1/4"  
 massiv, abgewinkelt, lang  
 solid, angled, long  
 macizo, angulado, largo  
 solide, coudé, long  
 pieno, angolare, lungo

Allgemeines Instrumentarium . Instrumentation générale . strumentario generale  
 Skalpellgriffe  
 Scalpel Handles  
 Mangos de bisturi  
 Manches pour bistouris  
 Manici per bisturi

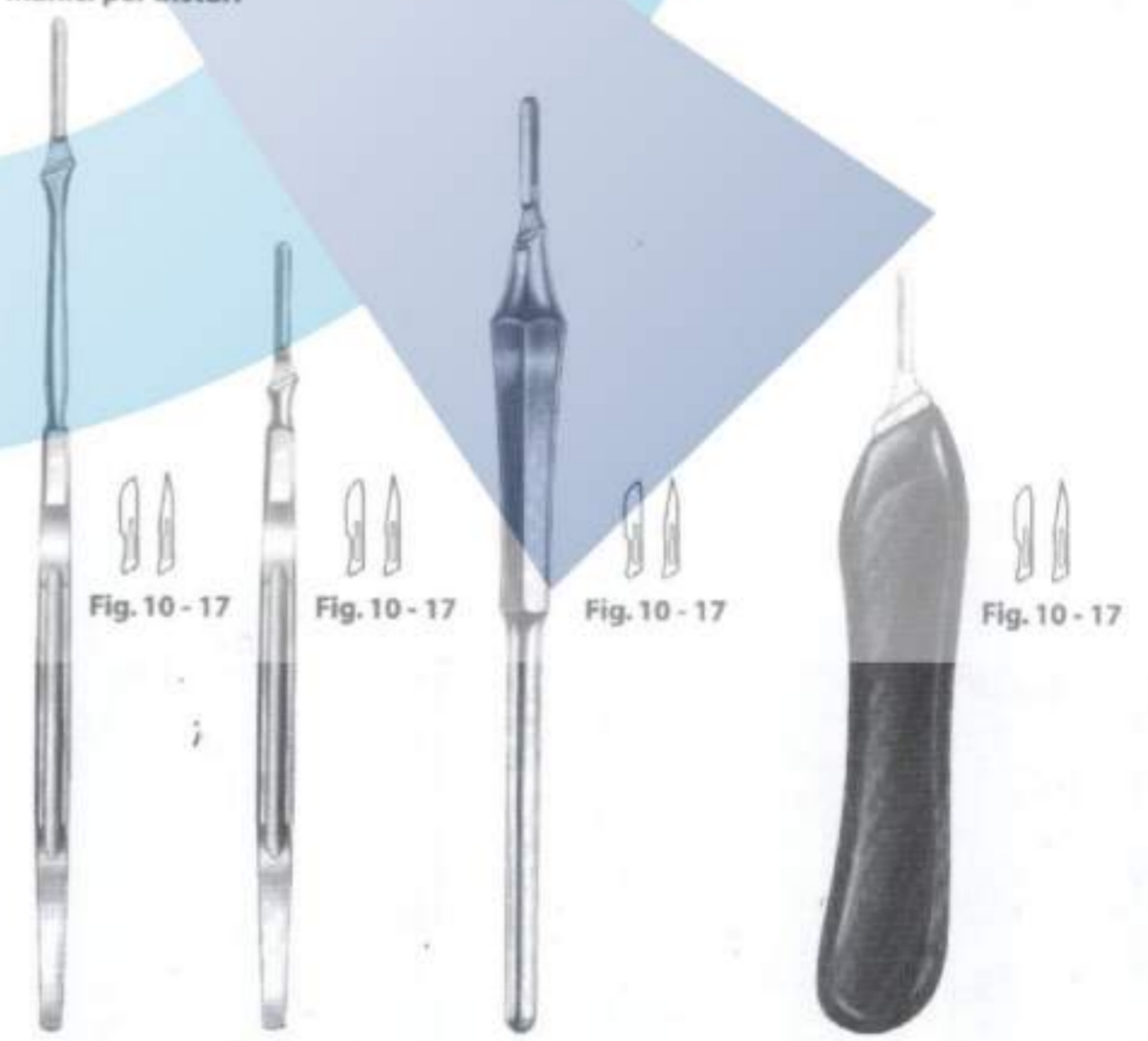

**MAB01-035**  
 No. 7  
 16 cm / 6 1/4"  
 massive  
 solid  
 macizo  
 solide  
 pieno

**MAB01-036**  
 No. 7K  
 12.5 cm / 5"  
 massive, kurz  
 solid, short  
 macizo, corto  
 solide, court  
 pieno, corto

**MAB01-037**  
 No. 3  
 15.5 cm / 6"  
 mit rundem Hohlheft  
 with round hollow handle  
 con mango hueco redondo  
 avec manche creux rond  
 con manico vuoto, rotondo

**MAB01-038**  
 No. 3  
 12.5 cm / 5"  
 mit Kunststoffheft  
 with plastic handle  
 con mango plástico  
 avec manche en matière pastique  
 con manico di materia plastica



**Allgemeines Instrumentarium . General Instrumentation . Instrumental general**  
**Skalpellgriffe**  
**Scalpel Handles**  
**Mangos de bisturi**  
**Manches pour bistouris**  
**Manici per bisturi**



Fig. 10 - 17



Fig. 10 - 17



Fig. 10 - 17

**MAB01-039**  
 No. 3  
 14.5 cm / 5 1/4"  
 massiv, rund  
 solid, round  
 macizo, redondo  
 solide, rond  
 pieno, rotondo

**MAB01-040**  
 No. 3  
 14 cm / 5 1/2"  
 massiv, rund, abgewinkelt  
 solid, round, angled  
 macizo, redondo, angulado  
 solide, rond, coudé  
 pieno, rotondo, angolare

**Kaye**  
**MAB01-041**  
 No. 3  
 15 cm / 6"  
 massiv, rund  
 solid, round  
 redondo  
 solide, rond  
 pieno, rotondo

**Allgemeines Instrumentarium . General instrumentation . instrumental general**  
**Einmalskalpelle**  
**Disposable Scalpels**  
**Bisturios desechables**  
**Bistouris à usage unique**  
**Bisturi per uso unico**



steril  
 einzeln verpackt  
 Packung mit 10 Stück  
 sterile  
 single packed  
 Package with 10 units  
 estérile  
 envase individual  
 paquete con 10 unidades

stérile  
 enveloppe individuelle  
 boîte de 10 bisturis  
 sterile  
 bustina individuale  
 scatola di 10 bisturi

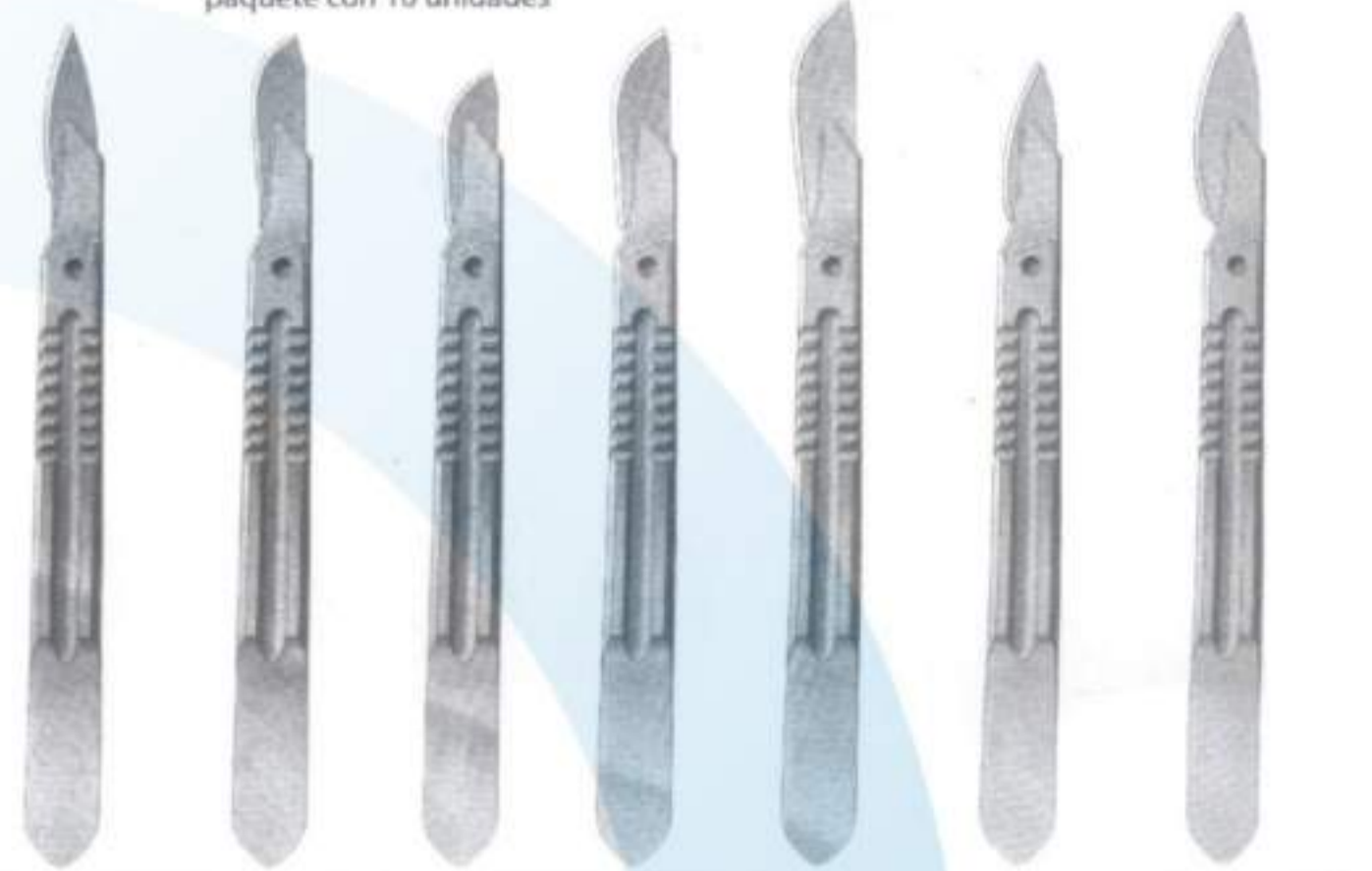

steril . sterile . estéril . stérile . sterile
MAB01-042 MAB01-043 MAB01-044 MAB01-045 MAB01-046 MAB01-047 MAB01-048
Fig. 18 Fig. 19 Fig. 20 Fig. 21 Fig. 22 Fig. 23 Fig. 24

**Allgemeines Instrumentarium . Instrumentation générale . Strumentario generale**  
**Einmalskalpelle**  
**Disposable Scalpels**  
**Bisturios desechables**  
**Bistouris à usage unique**  
**Bisturi per uso unico**

steril  
 einzeln verpackt  
 Packung mit 10 Stück  
 sterile  
 single packed  
 Package with 10 units  
 estérile  
 envase individual  
 paquete con 10 unidades

stérile  
 enveloppe individuelle  
 boîte de 10 bisturis  
 sterile  
 bustina individuale  
 scatola di 10 bisturi



steril . sterile . estéril . stérile . sterile
01-049 MAB01-050 MAB01-051 MAB01-052 MAB01-053 MAB01-054 MAB01-05
Fig. 10 Fig. 11 Fig. 12 Fig. 13 Fig. 15 Fig. 12 D Fig. 15 C

**Allgemeines Instrumentarium . General Instrumentation . Instrumental general**  
**Amputationsmesser, Zwischenknochenmesser**  
**Amputation Knives, Interosseous Knives**  
**Cuchillos para amputación, Cuchillos interóseos**  
**Coateaux à amputation, Coateaux interosseux**  
**Coltelli per amputazione, Coltelli interosseo**

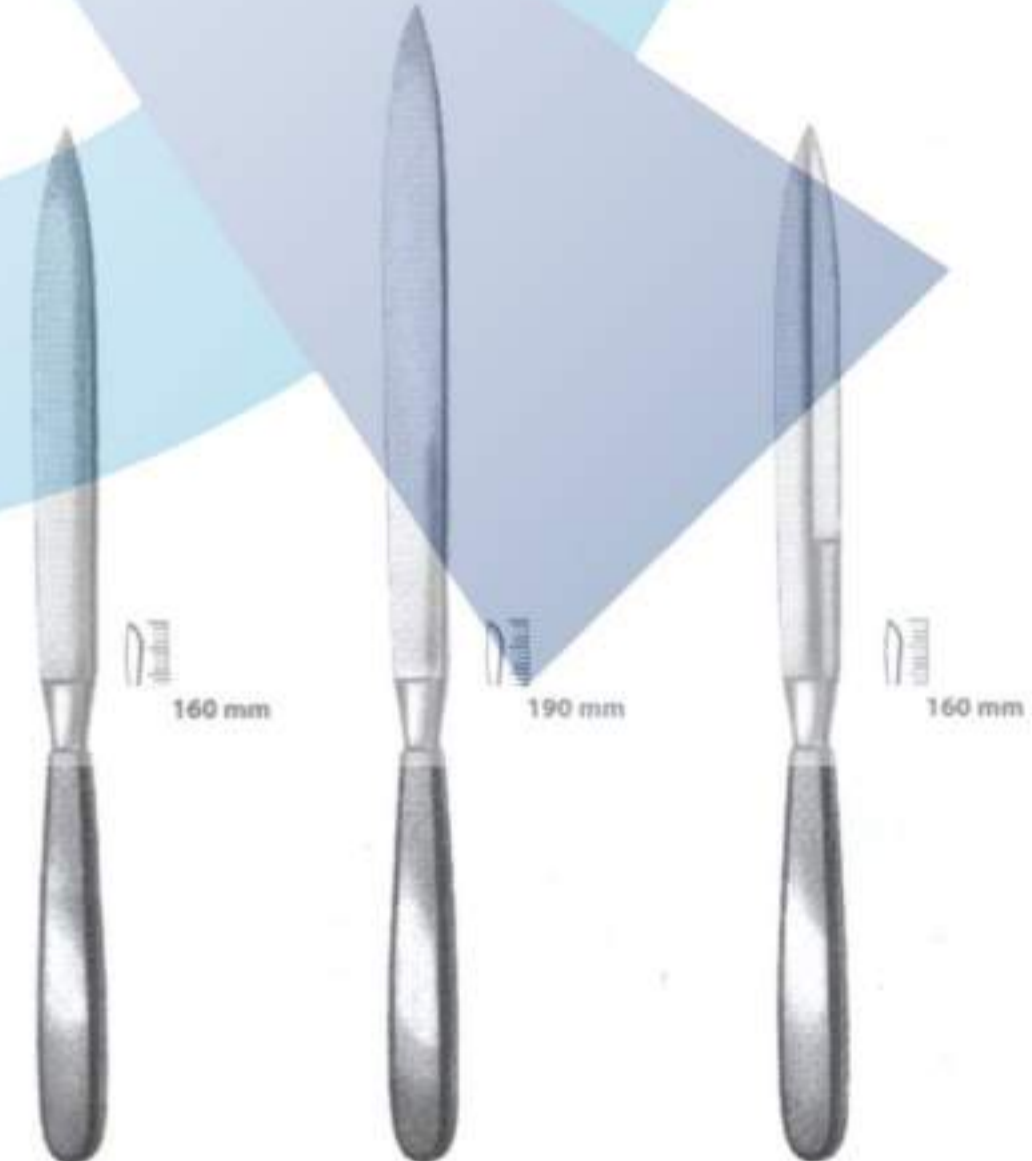

**MAB01-056**  
 29 cm / 11 1/2"  
 mit Hohlheft  
 with hollow handle  
 con mango hueco  
 avec manche creux  
 con manico vuoto

**MAB01-057**  
 32.5 cm / 12 3/4"  
 mit Hohlheft  
 with hollow handle  
 con mango hueco  
 avec manche creux  
 con manico vuoto

**Catlin**  
**MAB01-058**  
 29 cm / 11 1/2"  
 mit Hohlheft  
 with hollow handle  
 con mango hueco  
 avec manche creux  
 con manico vuoto



Allgemeines Instrumentarium . Instrumentation générale . Strumentario generale  
 Resektionsmesser  
 Resection Knives  
 Cuchillos para resección  
 Couteaux à résection  
 Coltelli per resezione

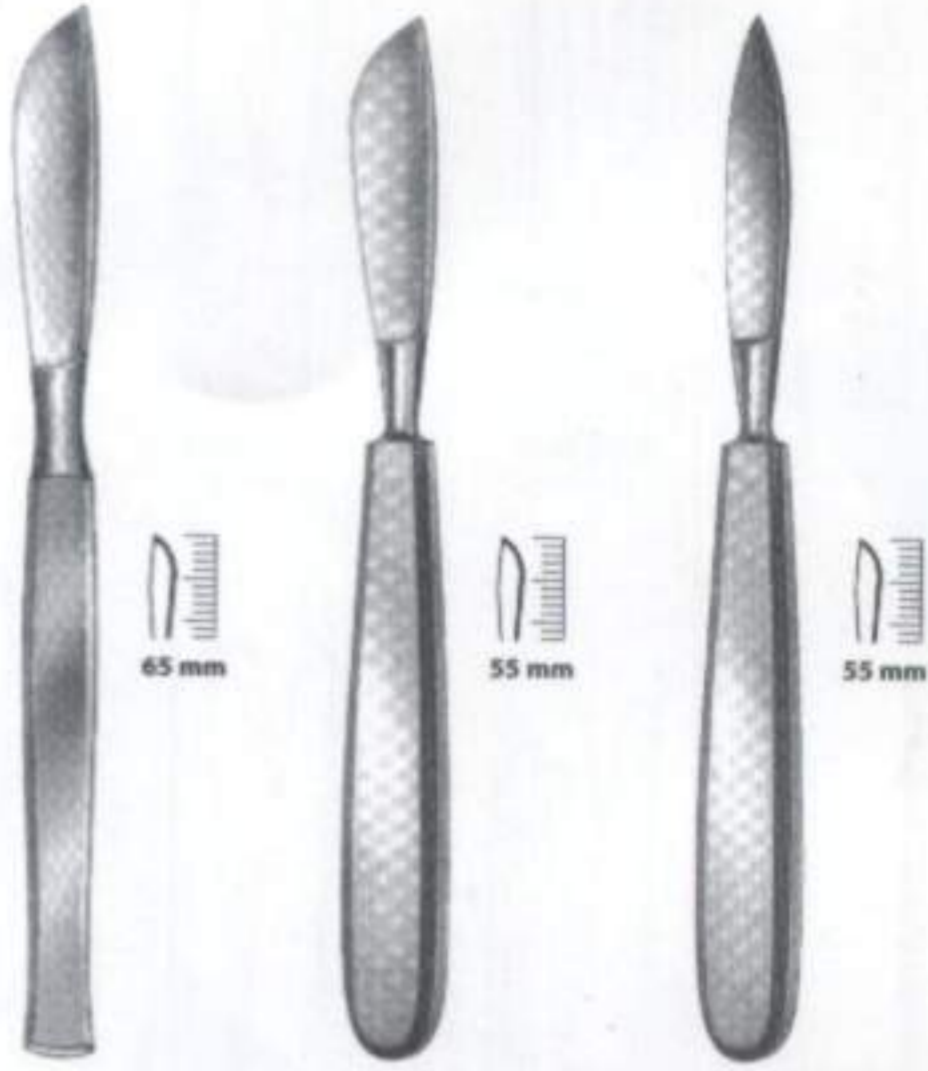

MAB 01-059 18 cm / 7"  
 MAB 01-060 18 cm / 7"  
 MAB 01-061 18 cm / 7"

massives Heft mit Schaber-Ende  
 solid handle, dissecting end  
 mango macizo, con periostótomo  
 manche solide à rugine  
 con manico pieno con raschino

Allgemeines Instrumentarium . General Instrumentation . Instrumental general  
 Rasiermesser  
 Razor Knives  
 Navajas  
 Rasoirs  
 Rasoi



MAB 01-062  
 Klinge beidseitig hohl  
 hollow blades on both sides  
 ambos lados cóncaves  
 lame deux faces concaves  
 lama concava / concava

MAB 01-063  
 Klinge flach/hohl  
 blade flat/hollow  
 hoja cóncava/convexa  
 lame à faces plane / concave  
 lama piana / concava

Allgemeines Instrumentarium . Instrumentation générale . Strumentario generale  
 Dermatomer  
 Dermatomes  
 Dermátomos  
 Dermatomes  
 Dermatomi

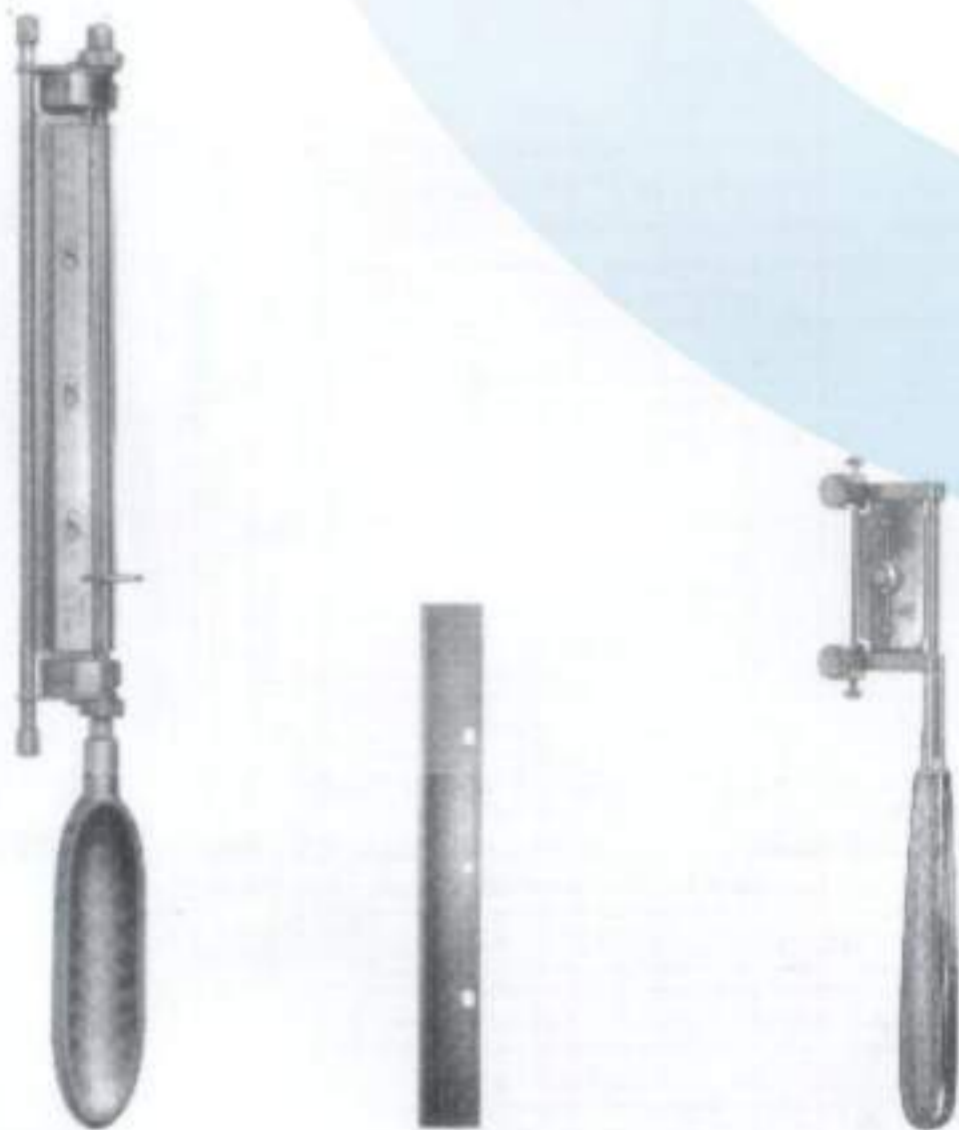

Humby  
 MAB 01-064  
 32 cm / 13"  
 komplett mit Klinge  
 complete with blade  
 completo con hoja  
 complet avec lame  
 completo con lama

Humby  
 MAB 01-065  
 Ersatzklinge  
 Spare Blade  
 Hoja de repuesto  
 Lame de rechange, seule  
 Lama di ricambio sola

Silver  
 MAB 01-066  
 19 cm / 7 1/2"  
 für handelsübliche Rasierklingen  
 for usual razor blades  
 para hojas de afeitar usuales  
 pour lames de rasoir modèle standard  
 per lamette da barba normali

MAB 01-115

Allgemeines Instrumentarium . General Instrumentation . Instrumental general  
 Dermatomer  
 Dermatomes  
 Dermátomos  
 Dermatomes  
 Dermatomi



Komplett  
 mit 2 Spannplatten  
 und einer Klinge  
 complete  
 with 2 skin fixing  
 plates and one  
 blade

completo  
 con 2 placas para  
 extender la piel y  
 una hoja

complet  
 avec deux plaque  
 pour tendre la peau  
 et lame

completo  
 con 2 placche per  
 stendere la pelle ed  
 una lama

Schink  
 MAB 01-067

Ersatzklinge  
 Spare Blade  
 Hoja de repuesto  
 Lame de rechange, seule  
 Lama di ricambio sola

MAB 01-120 mm

Schink  
 MAB 01-068

Spannplatte  
 Skin Fixing Plate  
 Placa para extender la piel  
 Plaque pour tendre la peau  
 Placca per stendere la pelle

MAB 01-120 mm

Schink  
 MAB 01-069  
 31 cm / 12 1/4"  
 einstellbar von 0,1 bis 2,0 mm  
 adjustable from 0,1 to 2,0 mm  
 ajustable de 0,1 hasta 2,0 mm  
 réglable en épaisseur de 0,01 à 2,0 mm  
 regolabile da 0,1 a 2,0 mm

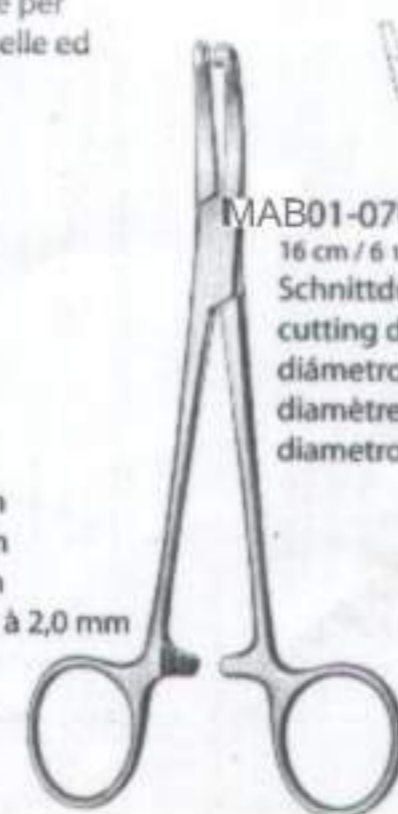

MAB 01-070  
 16 cm / 6 1/4"  
 Schnittdurchmesser 4 mm  
 cutting diameter 4 mm  
 diámetro del corte 4 mm  
 diamètre du tranchant 4 mm  
 diametro di taglio 4 mm

MAB 01-071  
 16 cm / 6 1/4"  
 Schnittdurchmesser 5 mm  
 cutting diameter 5 mm  
 diámetro del corte 5 mm  
 diamètre du tranchant 5 mm  
 diametro di taglio 5 mm



## MAB 02

Scheren  
Scissors  
Tijeras  
Ciseaux  
Forbici

Allgemeines Instrumentarium . General Instrumentation . Instrumental general  
Chirurgische Scheren  
Operating Scissors  
Tijeras quirúrgicas  
Ciseaux chirurgicaux  
Forbici per chirurgia

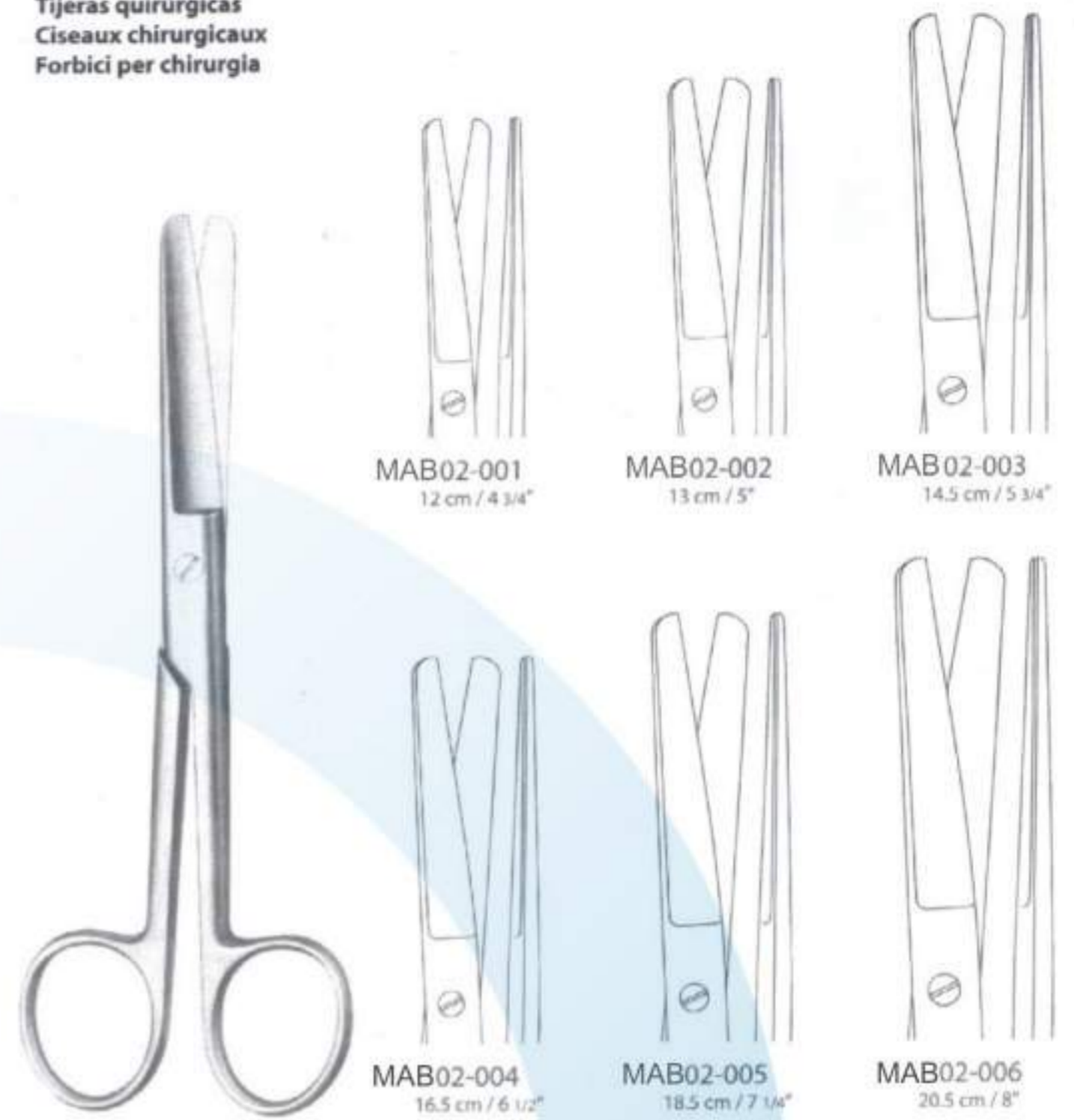

Allgemeines Instrumentarium . Strumentation générale . Strumentario generale  
Chirurgische Scheren  
Operating Scissors  
Tijeras quirúrgicas  
Ciseaux chirurgicaux  
Forbici per chirurgia



Allgemeines Instrumentarium . General Instrumentation . Instrumental general  
Chirurgische Scheren  
Operating Scissors  
Tijeras quirúrgicas  
Ciseaux chirurgicaux  
Forbici per chirurgia

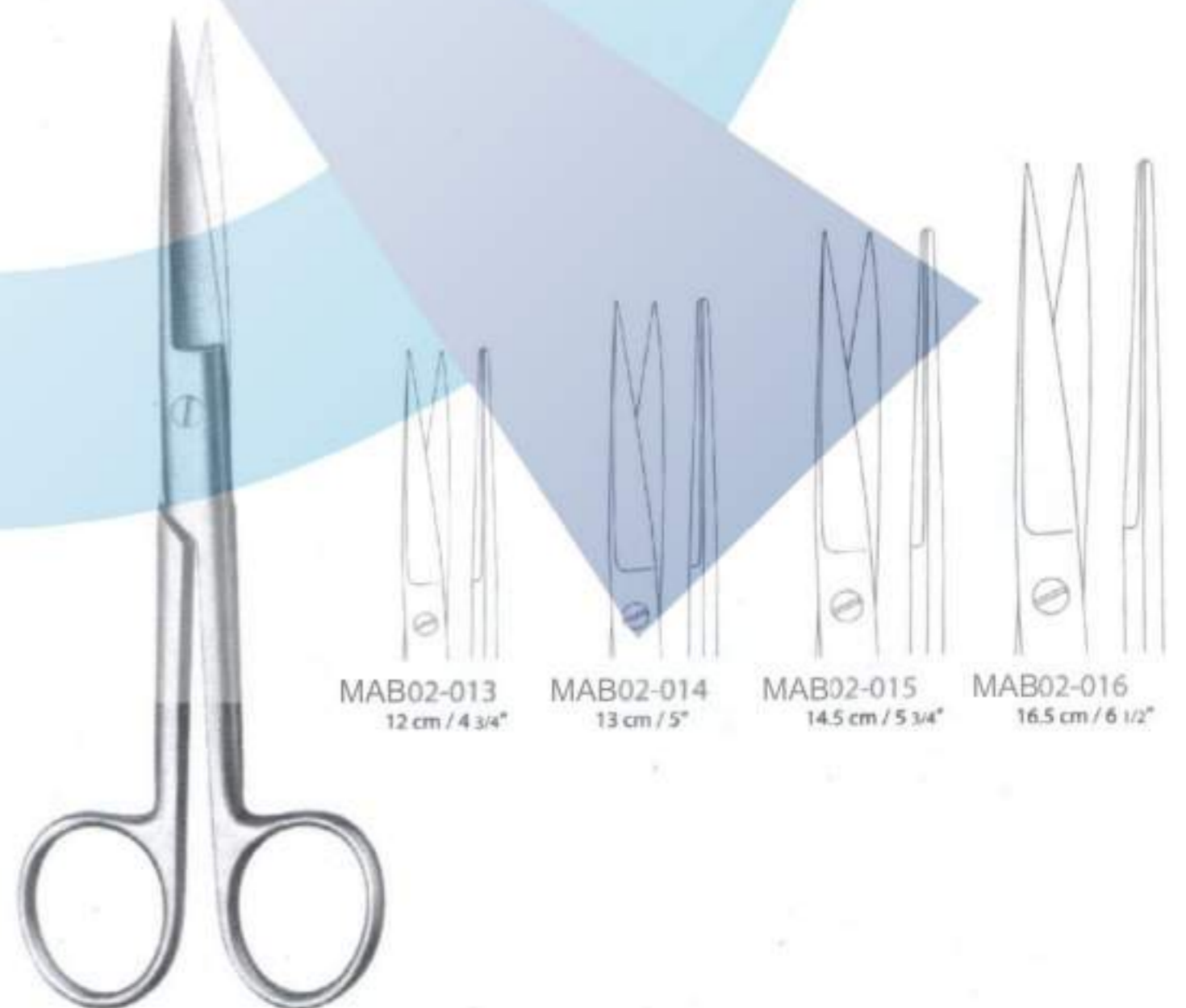



Allgemeines Instrumentarium . Instrumentation générale . Strumentario generale

Chirurgische Scheren  
Operating Scissors  
Tijeras quirúrgicas  
Ciseaux chirurgicaux  
Forbici per chirurgia



Allgemeines Instrumentarium . General Instrumentation . Instrumental general

Chirurgische Scheren  
Operating Scissors  
Tijeras quirúrgicas  
Ciseaux chirurgicaux  
Forbici per chirurgia

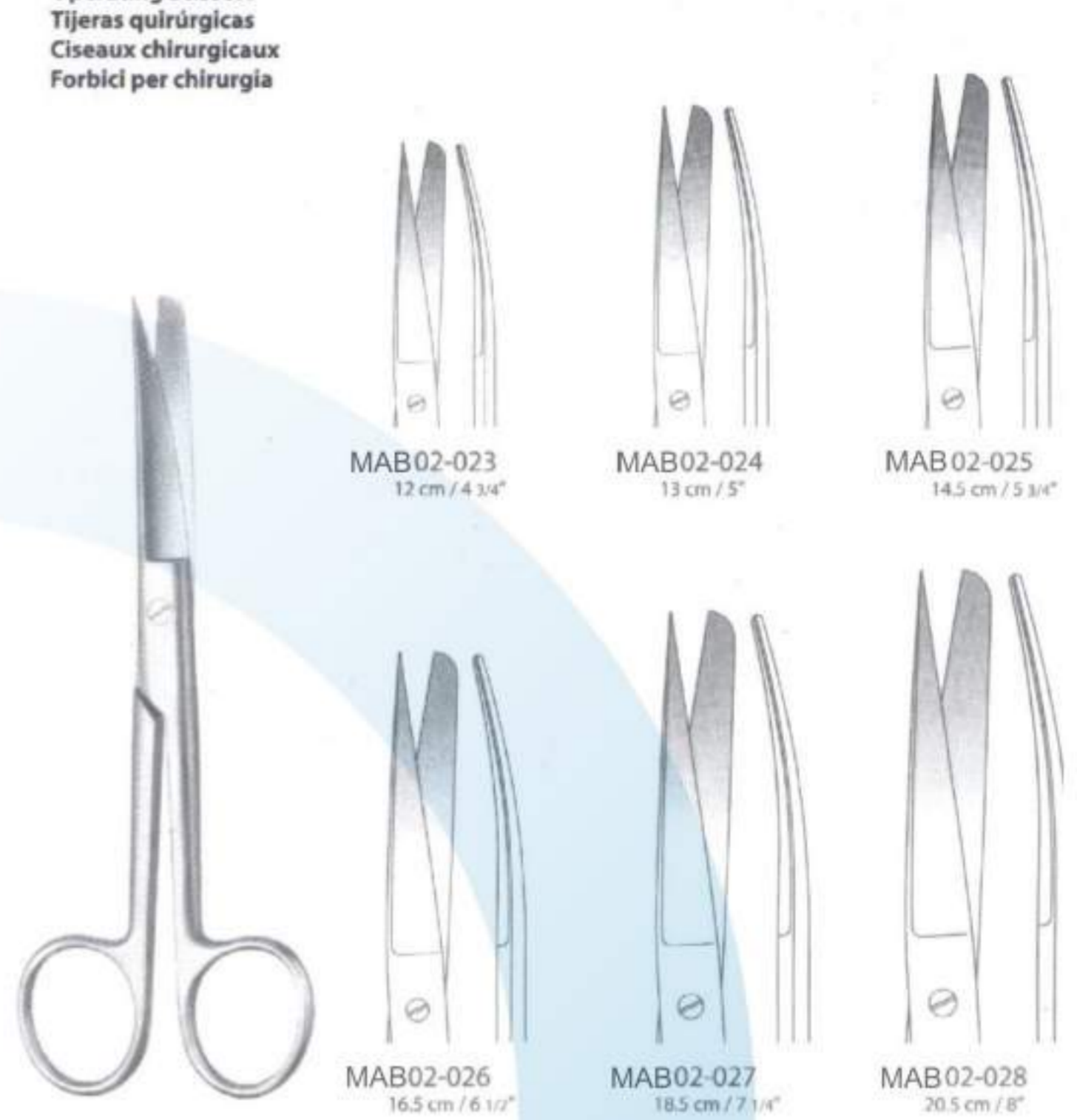

Allgemeines Instrumentarium . Instrumentation général . Strumentario generale

Chirurgische Scheren  
Operating Scissors  
Tijeras quirúrgicas  
Ciseaux chirurgicaux  
Forbici per chirurgia



Allgemeines Instrumentarium . General Instrumentation . Instrumental general

Chirurgische Scheren  
Operating Scissors  
Tijeras quirúrgicas  
Ciseaux chirurgicaux  
Forbici per chirurgia





Allgemeines Instrumentarium . Instrumentation générale . Strumentario generale  
 Chirurgische Scheren  
 Operating Scissors  
 Tijeras quirúrgicas  
 Ciseaux chirurgicaux  
 Forbici per chirurgia



MAB02-039  
14.5 cm / 5 3/4"

Inzisionsschere  
 Incision Scissors  
 Tijera para incisiones  
 Ciseaux à incision  
 Forbici per incisione



MAB02-040  
14 cm / 5 1/2"

Deaver



MAB02-041  
14 cm / 5 1/2"

Allgemeines Instrumentarium . General Instrumentation . Instrumental general  
 Präparierscheren  
 Dissecting Scissors  
 Tijeras quirúrgicas  
 Ciseaux à dissection  
 Forbici per dissezione



Mayo

MAB02-042  
14.5 cm / 5 3/4"

MAB02-043  
15 cm / 6"

MAB02-044  
17 cm / 6 3/4"

MAB02-045  
23.5 cm / 9 1/4"



MAB02-046  
14.5 cm / 5 3/4"



MAB02-047  
15 cm / 6"



MAB02-048  
17 cm / 6 3/4"



MAB02-049  
23.5 cm / 9 1/4"



Mayo-Harrington



MAB02-050  
23 cm / 9"



MAB02-051  
22.5 cm / 9"



MAB02-052  
28 cm / 11"

Allgemeines Instrumentarium . Instrumentation générale . Strumentario generale  
 Präparierscheren  
 Dissecting Scissor  
 Tijeras quirúrgicas  
 Ciseaux à dissection  
 Forbici per dissezione



Mayo-Stillie



MAB02-053  
15 cm / 6"



MAB02-054  
17 cm / 8 1/4"



MAB02-055  
15 cm / 6"



MAB02-056  
17 cm / 8 1/4"

Allgemeines Instrumentarium . General Instrumentation . Instrumental general  
 Präparierscheren  
 Dissecting Scissor  
 Tijeras quirúrgicas  
 Ciseaux à dissection  
 Forbici per dissezione



Mayo-Stillie

MAB02-057  
16 cm / 6 1/4"

MAB02-058  
19.5 cm / 7 3/4"

MAB02-059  
21.5 cm / 8 1/2"



MAB02-060  
16 cm / 6 1/4"



MAB02-061  
19.5 cm / 7 3/4"



MAB02-062  
21.5 cm / 8 1/2"

Allgemeines Instrumentarium . Instrumentation générale . Strumentario generale  
 Gynäkologische Scheren  
 Gynecological Scissors  
 Tijeras para ginecología  
 Ciseaux à gynécologie  
 Forbici per ginecologia



Mayo-Noble  
16.5 cm / 6 1/2"



MAB02-063



MAB02-064



Allgemeines Instrumentarium . General Instrumentation . Instrumental general  
 Gynäkologische Scheren  
 Gynecological Scissors  
 Tijeras para ginecología  
 Ciseaux à gynécologie  
 Forbici per ginecologia

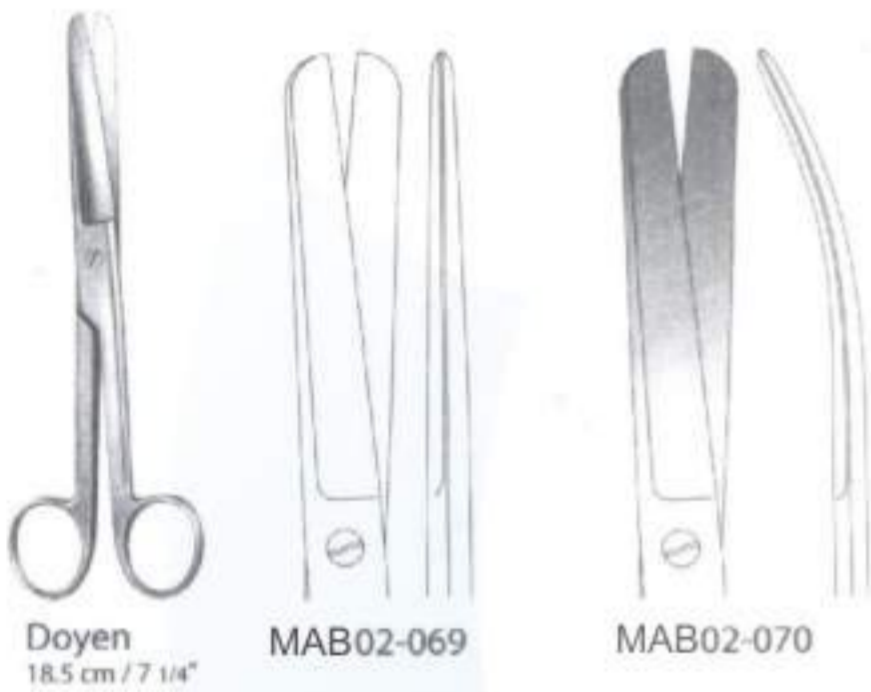
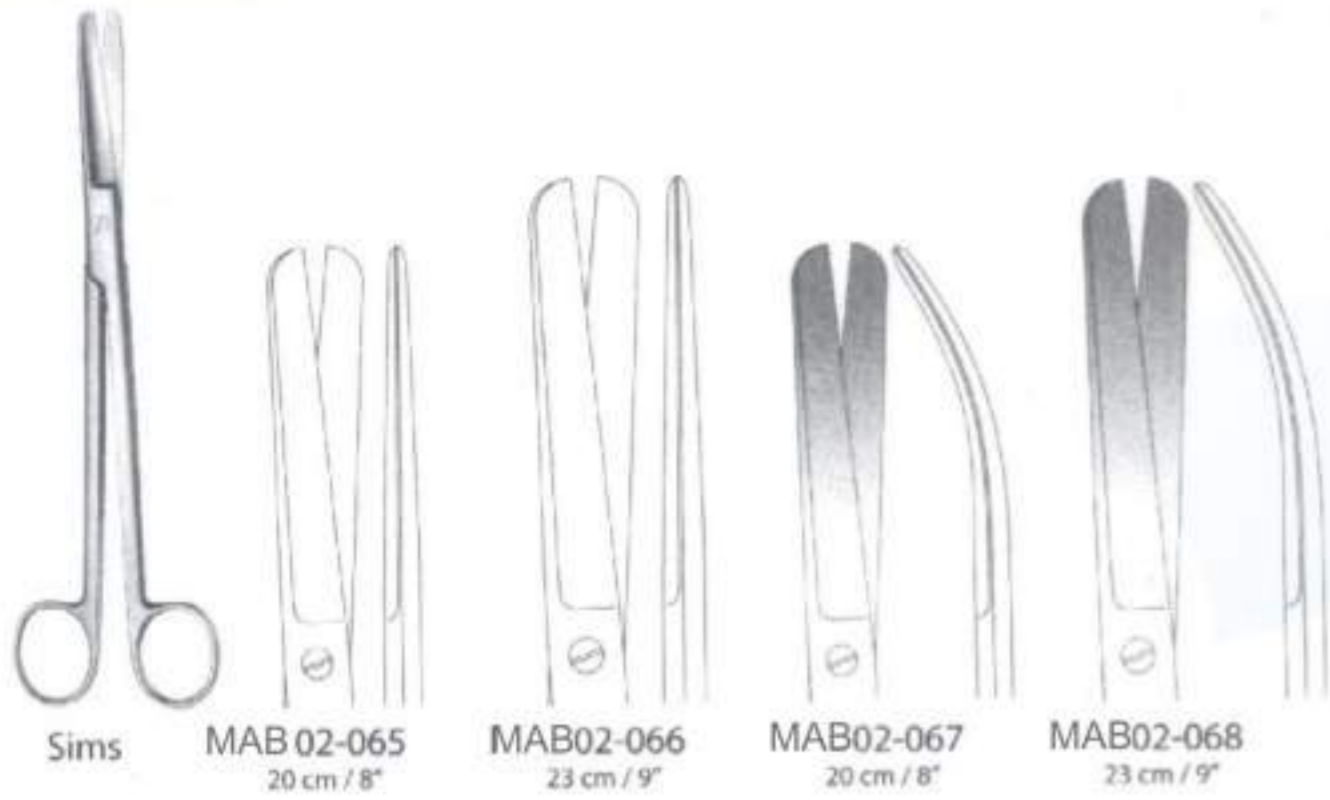

Allgemeines Instrumentarium . Instrumentation générale . Strumentario generale  
 Gynäkologische Scheren  
 Gynecological Scissors  
 Tijeras para ginecología  
 Ciseaux à gynécologie  
 Forbici per ginecologia



Allgemeines Instrumentarium . General Instrumentation . Instrumental general  
 Chirurgische Scheren, Präparierscheren  
 Operating Scissors, Dissecting Scissors  
 Tijeras quirúrgicas, Tijeras de disección  
 Ciseaux chirurgicaux, Ciseaux à dissection  
 Forbici per ginecologia, Forbici per dissezione



Allgemeines Instrumentarium . Instrumentation générale . Strumentario generale  
 Präparierscheren  
 Dissecting Scissors  
 Tijeras de disección  
 Ciseaux à dissection  
 Forbici per dissezione

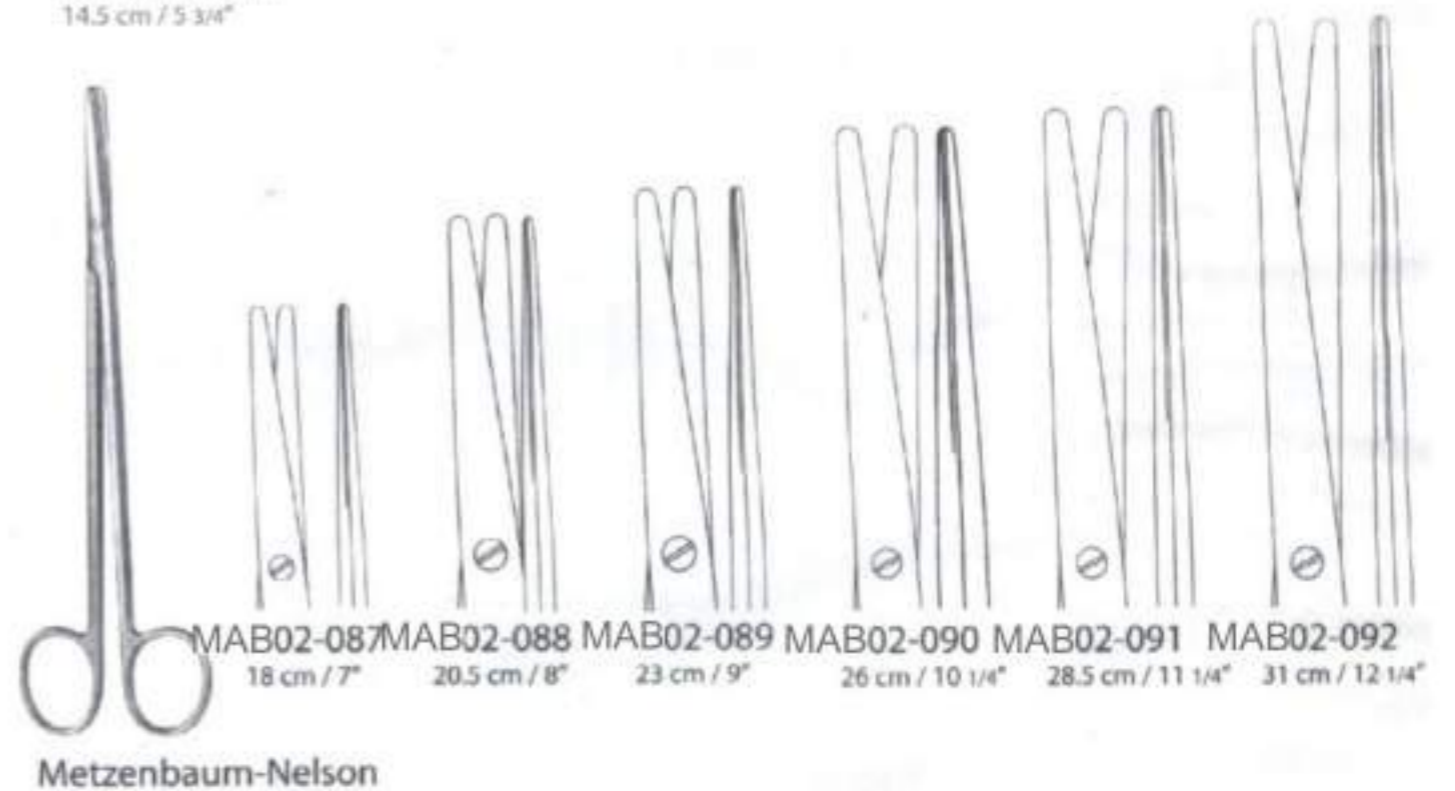



Allgemeines Instrumentarium . General Instrumentation . Instrumental general

Präparierscheren  
Dissecting Scissors  
Tijeras de disección  
Ciseaux à dissection  
Forbici per dissezione

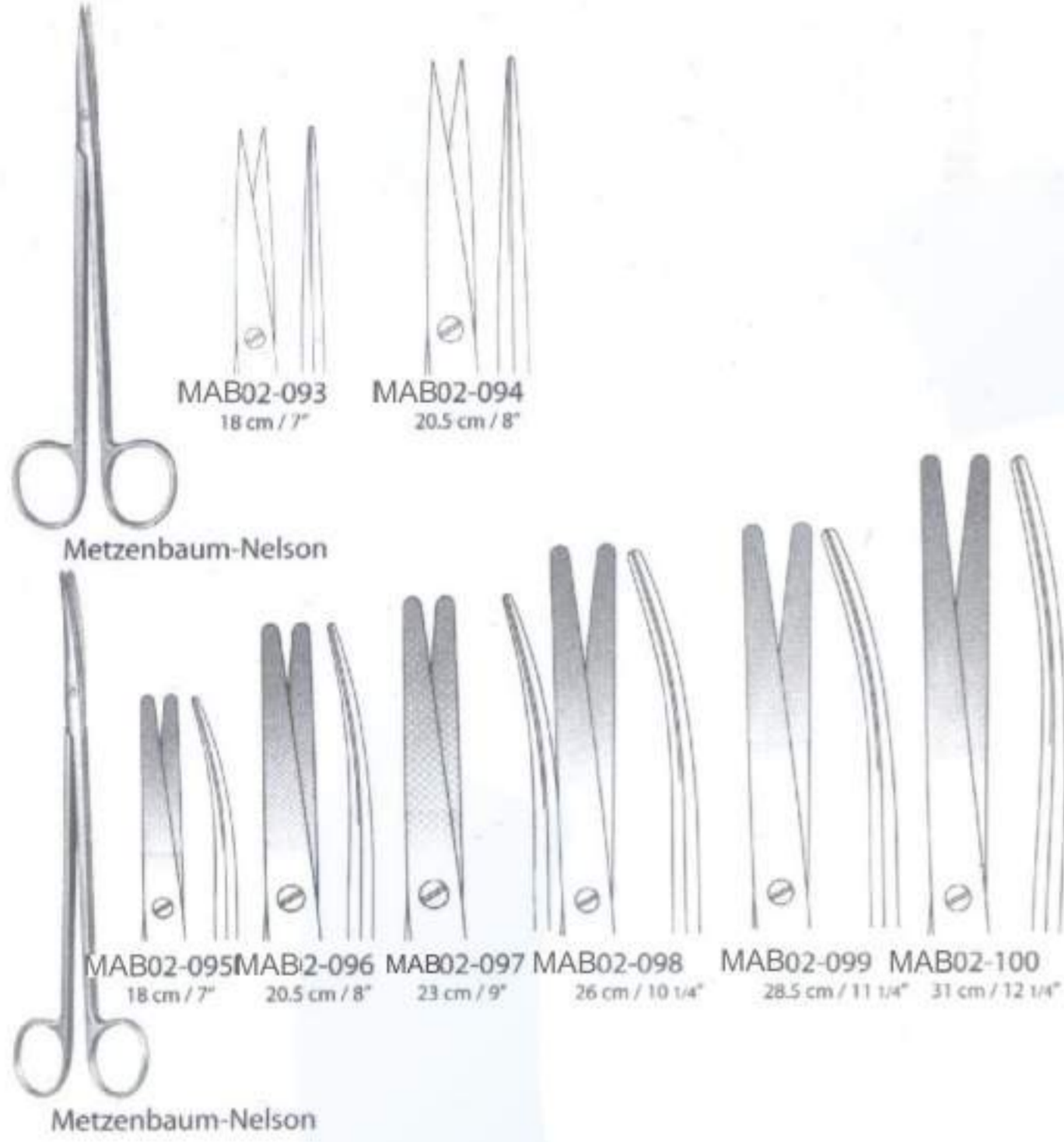

Allgemeines Instrumentarium . Instrumentation générale . Strumentario generale

Präparierscheren  
Dissecting Scissors  
Tijeras de disección  
Ciseaux à dissection  
Forbici per dissezione

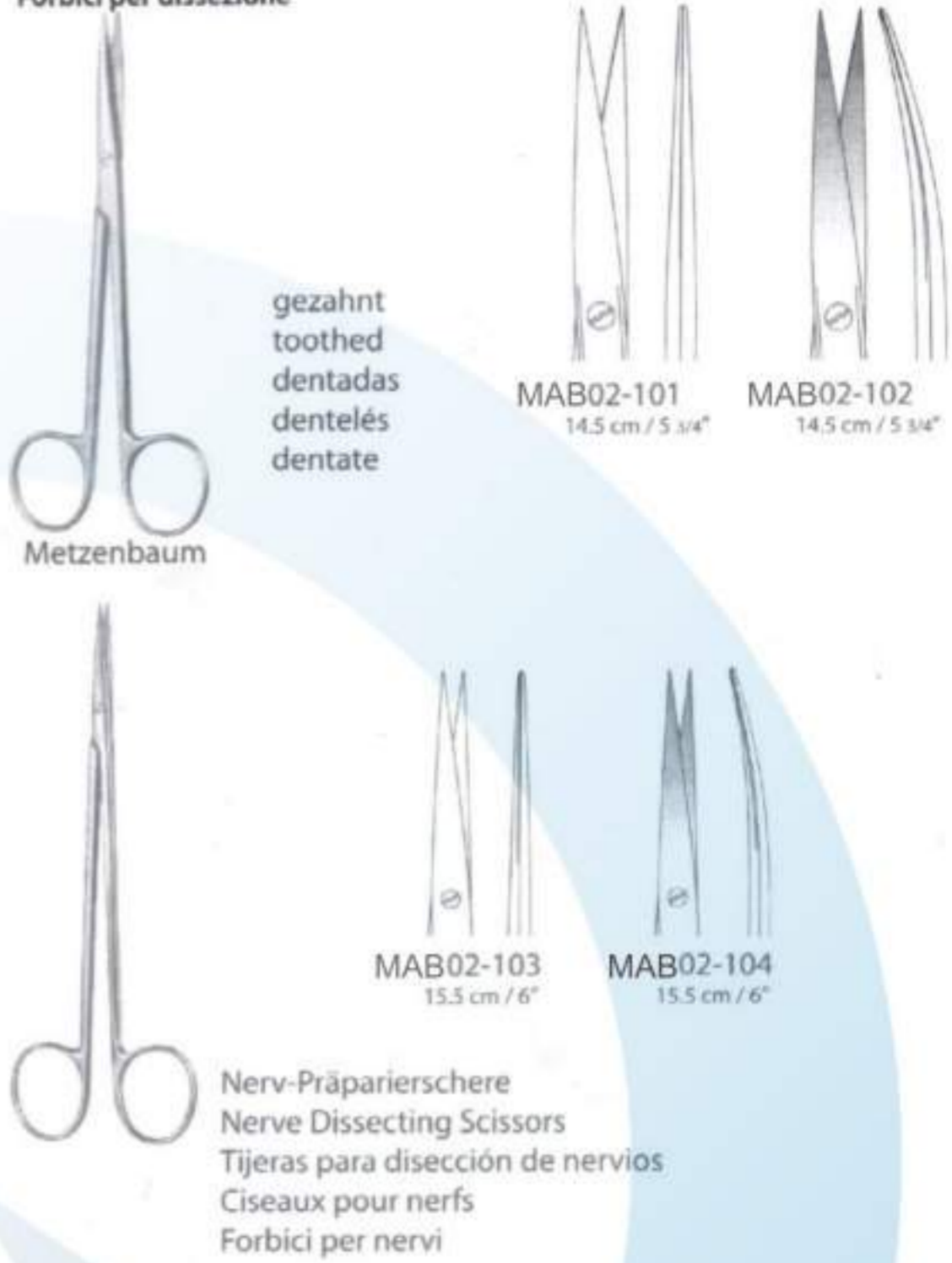

Allgemeines Instrumentarium . General Instrumentation . Instrumental general

Face-lift Scheren  
Face-lift Scissors  
Tijeras para Face-Lift  
Ciseaux pour Face-Lift  
Forbici per Face-lift



Allgemeines Instrumentarium . Instrumentation générale . Strumentario generale

Präparierscheren, Nasenscheren  
Dissecting Scissors, Nasal Scissors  
Tijeras de disección, Tijeras nasales  
Ciseaux à dissection, Ciseaux nasaux  
Forbici per dissezione, Forbici nasali

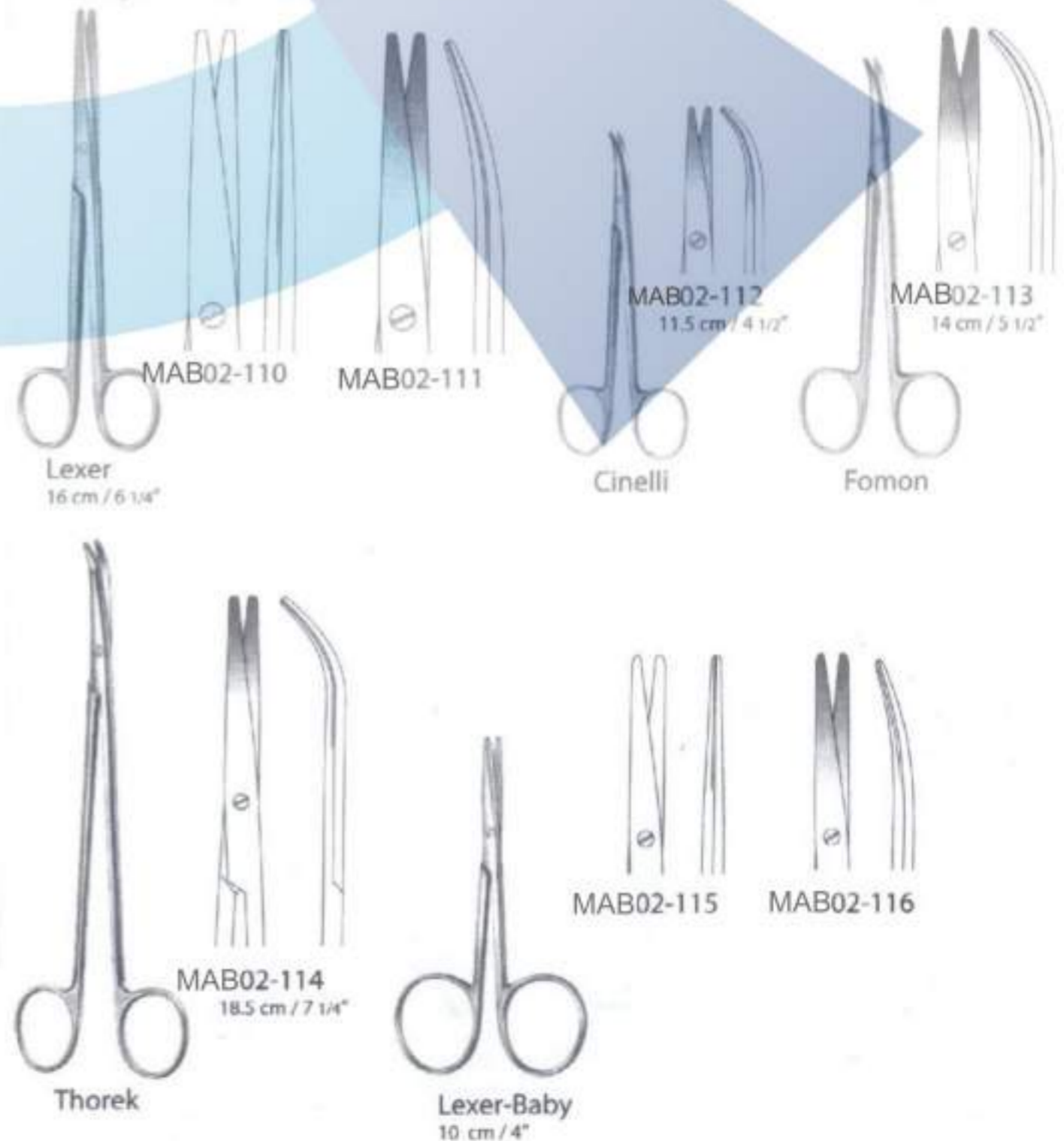



**Allgemeines Instrumentarium . General Instrumentation . Instrumental general**  
**Feine Präparierscheren**  
**Delicate Dissecting Scissors**  
**Tijeras finas de disección**  
**Ciseaux fins à dissection**  
**Forbici fini per dissezione**

**Lexer-Fino**  
**MAB02-117**  
 16.5 cm / 6 1/2"  
 schlankes Modell  
 slender pattern  
 modelo delgado  
 modèle gracile  
 modello delicato

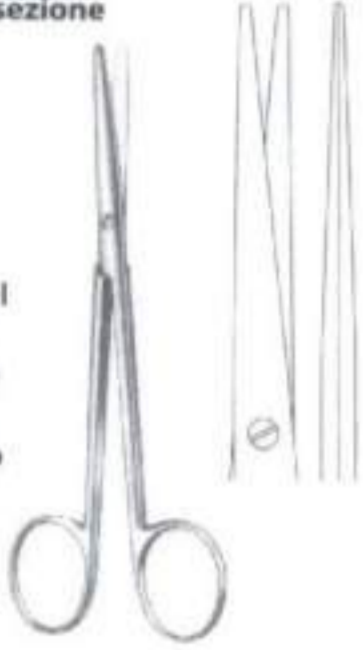

**Lexer-Fino**  
**MAB02-118**  
 16.5 cm / 6 1/2"  
 schlankes Modell  
 slender pattern  
 modelo delgado  
 modèle gracile  
 modello delicato



**Allgemeines Instrumentarium . Instrumentation générale . Instrumentario generale**  
**Felne Präparierscheren**  
**Delicate Dissecting Scissors**  
**Tijeras finas de disección**  
**Ciseaux fins à dissection**  
**Fobici fini per dissezione**

**MAB02-123** 18 cm / 7"    **MAB02-124** 20 cm / 8"    **MAB02-125** 23 cm / 9 1/4"  
**MAB02-126** 18 cm / 7"    **MAB02-127** 20 cm / 8"    **MAB02-128** 23 cm / 9"



**Metzenbaum-Fino**  
 schlankes Modell  
 slender pattern  
 modelo delgado  
 modèle gracile  
 modello delicato

**Metzenbaum-Fino**  
 schlankes Modell  
 slender pattern  
 modelo delgado  
 modèle gracile  
 modello delicato

**Metzenbaum-Fino**  
**MAB02-119**  
 14.5 cm / 5 3/4"  
 schlankes Modell  
 slender pattern  
 modelo delgado  
 modèle gracile  
 modello delicato

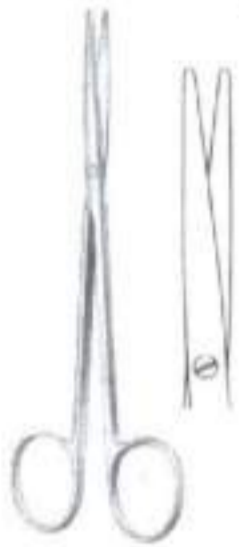

**Metzenbaum-Fino**  
**MAB02-120**  
 14.5 cm / 5 3/4"  
 schlankes Modell  
 slender pattern  
 modelo delgado  
 modèle gracile  
 modello delicato



**Metzenbaum-Fino**  
**MAB02-121**  
 14.5 cm / 5 3/4"  
 schlankes Modell  
 slender pattern  
 modelo delgado  
 modèle gracile  
 modello delicato



**Metzenbaum-Fino**  
**MAB02-122**  
 14.5 cm / 5 3/4"  
 schlankes Modell  
 slender pattern  
 modelo delgado  
 modèle gracile  
 modello delicato



S-förmig gebogen  
 schlankes Modell  
 S-shaped  
 slender pattern  
 forma S  
 modelo delgado  
 courbés en S  
 modèle gracile  
 curve in forma S  
 modello delicato



**MAB02-129** 18 cm / 7"    **MAB02-130** 20 cm / 8"    **MAB02-131** 23 cm / 9"

**Allgemeines Instrumentarium . General Instrumentation . Instrumental general**  
**Präparierscheren, Chirurgische Scheren**  
**Dissecting Scissors, Operating Scissors**  
**Tijeras de disección, Tijeras quirúrgicas**  
**Ciseaux à dissection, Ciseaux chirurgicaux**  
**Forbici per dissezione, Forbici per chirurgia**



**MAB 02-132**  
 12.5 cm / 5"  
 feines Modell  
 fine pattern  
 modelo fino  
 modèle fin  
 modello delicato



**MAB 02-133**  
 18 cm / 7"  
 feines Modell  
 fine pattern  
 modelo fino  
 modèle fin  
 modello delicato



**Sanvenero**  
**MAB 02-134**  
 14 cm / 5 1/2"

**Sanvenero**  
**MAB 02-135**  
 14 cm / 5 1/2"

**Allgemeines Instrumentarium . Instrumentation générale . Strumentario generale**  
**Face-lift Scheren, Präparierscheren**  
**Face-lift Scissors, Dissecting Scissors**  
**Tijeras para Face-lift, Tijeras de disección**  
**Ciseaux pour Face-lift, Ciseaux à dissection**  
**Forbici per Face-lift, Forbici per dissezione**



**MAB02-140**  
 14.5 cm / 5 3/4"

**MAB 02-141**  
 14.5 cm / 5 3/4"

**MAB02-142**  
 14.5 cm / 5 3/4"

**MAB02-143**  
 14.5 cm / 5 3/4"

**Peck-Joseph**

**Peck-Joseph**

**Salyer**  
 für Lippen-, Kiefer-, Gaumenspalte  
 for Cleft Palate  
 para fisura paladar  
 pour fente du palais  
 per cheilo-labbro-palato schisi

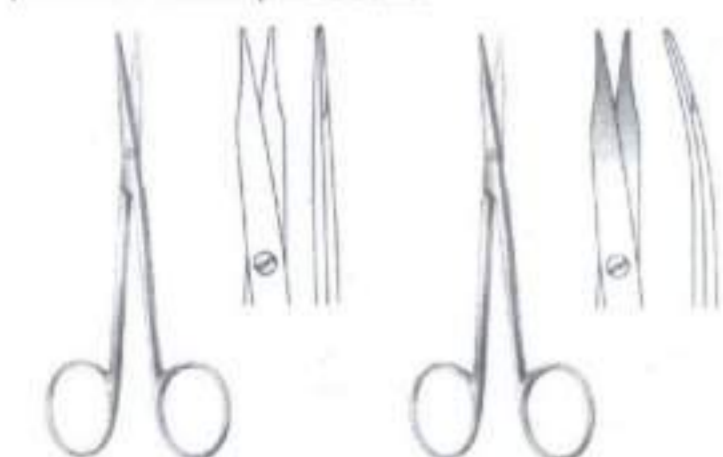

**MAB 02-136**  
 11.5 cm / 4 1/2"

**MAB 02-137**  
 11.5 cm / 4 1/2"



**MAB 02-138** 14.5 cm / 5 3/4"    **MAB 02-139** 14.5 cm / 5 3/4"

**Joseph**



**Shea Vein Graft**  
**MAB02-144**  
 12 cm / 4 3/4"



**MAB02-145**  
 12 cm / 4 3/4"

**MAB02-146**  
 15 cm / 6"

**Kilner**



Allgemeines Instrumentarium . General Instrumentation . Instrumental general  
 Dissektionsscheren, Präparierscheren  
 Dissecting Scissors  
 Tijeras de disección  
 Ciseaux à dissection  
 Forbici per dissezione



Allgemeines Instrumentarium . Instrumentation générale . Strumentario generale  
 Gefäßscheren, Präparierscheren  
 Vascular Scissors, Dissecting Scissors  
 Tijeras vasculares, Tijeras de disección  
 Ciseaux vasculaires, Ciseaux à dissection  
 Forbici vascolari, Forbici per dissezione

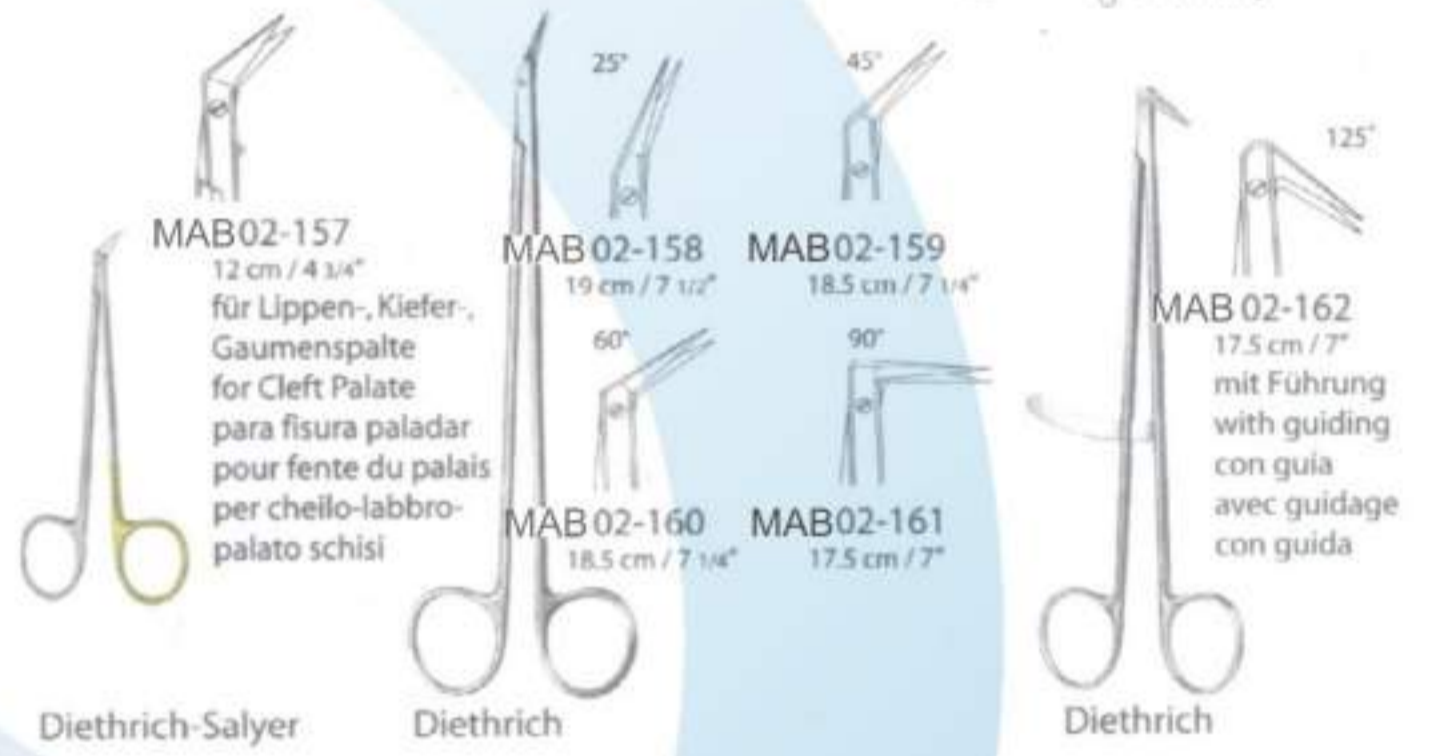

Allgemeines Instrumentarium . General Instrumentation . Instrumental general  
 Gefäßscheren  
 Vascular Scissors  
 Tijeras vasculares  
 Ciseaux vasculaires  
 Forbici vascolari

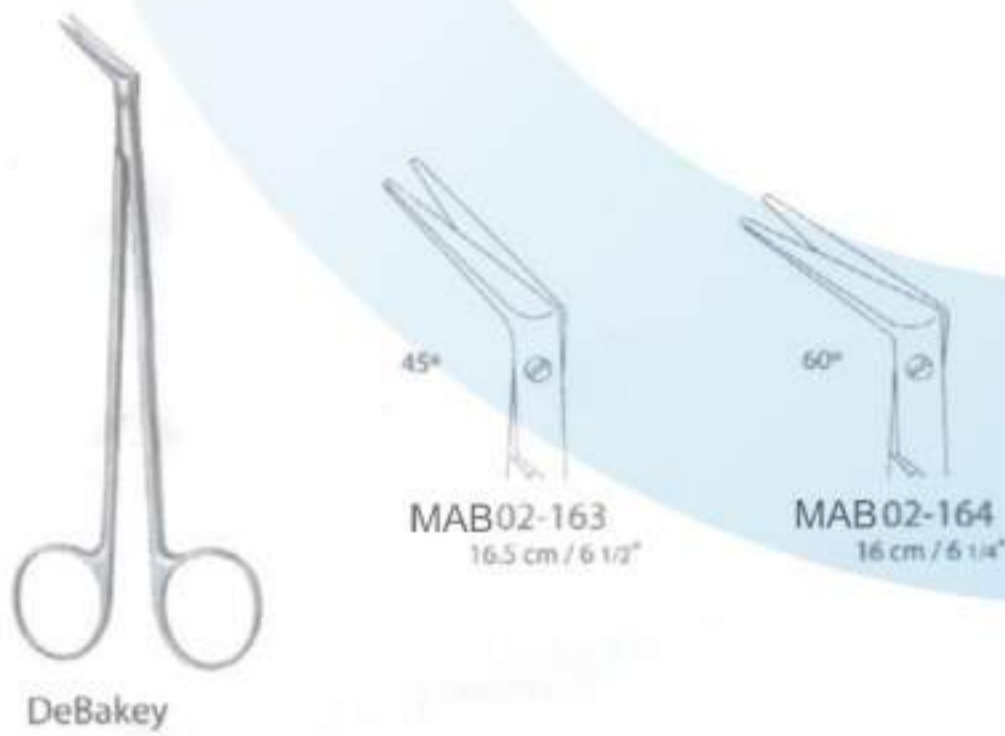

Allgemeines Instrumentarium . Instrumentation générale . Strumentario generale  
 Coronarscheren  
 Coronary Scissors  
 Tijeras coronarias  
 Ciseaux coronaires  
 Forbici per arteria coronaria

10 mm					
Stahl . Steel . Acero . Acier . Acciaio	25°	45°	60°	90°	125°
18 cm / 7"	MAB02-170	MAB02-171	MAB02-172	MAB02-173	MAB02-174



**Titanium**

diamantierte  
 Schneiden  
 diamond  
 coated cutting  
 edges  
 filo diamantato  
 lames  
 diamantées  
 lame  
 diamantate

Titan . Titanium . Titahio . Titane . Titanio	25°	45°	60°	90°	125°
18 cm / 7"	MAB02-175	MAB02-176	MAB02-177	MAB02-178	MAB02-179

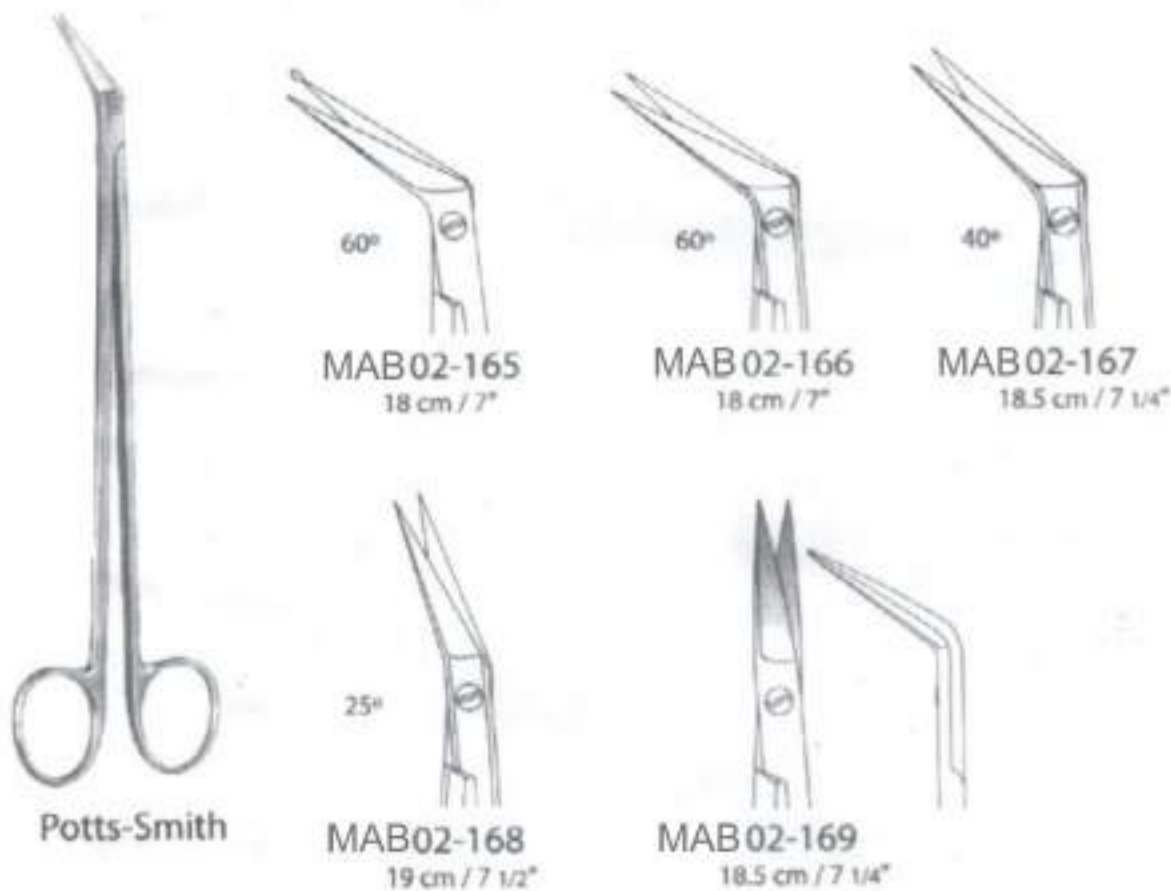



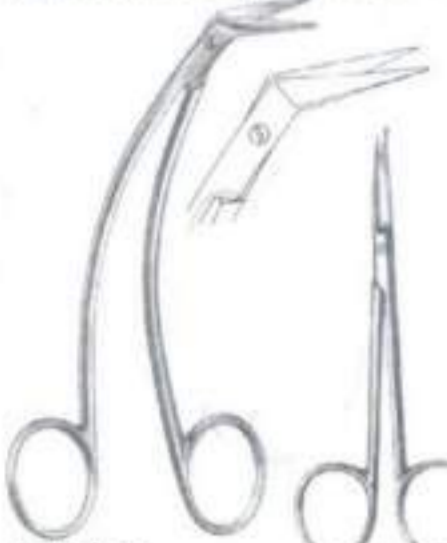

**Allgemeines Instrumentarium . General Instrumentation . Instrumental general**  
**Gefäßscheren, Präparierscheren**  
**Vascular Scissors, Dissecting Scissors**  
**Tijeras vasculares, Tijeras de disección**  
**Ciseaux vasculaires, Ciseaux à dissection**  
**Forbici vascolari, Forbici per dissezione**



**Favoloro**  
MAB02-180  
15 cm / 6"



**MAB02-181**  
12 cm / 4 3/4"



**Olivecrona**  
MAB02-182  
23 cm / 9"

gezahnt  
toothed  
dentada  
dentelés  
dentate

ein Blatt mit Knopfende  
one blade pointed  
una hoja abotonada  
una lama con punta a  
forma di bottone

**Trigeminusschere**  
(auch für die Nase)  
**Trigeminal Scissors**  
(also for nose)  
**Tijeras para nervio trigémino**  
(también para la nariz)  
**Ciseaux pour le nerf trigéminale**  
(aussi pour le nez)  
**Forbici per il nervo trigemino**  
(anche per il naso)



**Strully**  
MAB02-183  
22.5 cm / 8 3/4"



**Schmieden-Taylor**  
MAB02-184  
16.5 cm / 6 1/2"



**Toennis-Adson**  
MAB02-185  
17.5 cm / 7"

**Allgemeines Instrumentarium . Instrumentation générale . Strumentario generale**  
**Tonsillenscheren, Nasenscheren**  
**Tonsil Scissors, Nasal Scissors**  
**Tijeras para amígdalas, Tijeras nasales**  
**Ciseaux pour les amygdales, Ciseaux nasaux**  
**Forbici per tonsille, Forbici nasali**



**Dean**



**MAB02-186**  
17.5 cm / 7"  
aufgewinkelt  
angled upwards  
angulada  
coudée en haut  
angolari sul piatto



**MAB02-187**  
17.5 cm / 7"  
gezahnt, aufgewinkelt  
toothed, angled upwards  
dentada, angulada  
dentelés, coudée en haut  
dentate, angolari sul piatto



**MAB02-188**  
19.5 cm / 7 3/4"

**Good**



**TC GOLD**  
**Fomon**  
MAB02-189  
14.5 cm / 5 3/4"



**Cottle**  
MAB02-190  
16 cm / 6 1/4"



**Fomon**  
MAB02-191  
15 cm / 5"

**Allgemeines Instrumentarium . General Instrumentation . Instrumental general**  
**Nasenscheren**  
**Nasal Scissors**  
**Tijeras nasales**  
**Ciseaux nasaux**  
**Forbici nasali**



**Cottle**  
MAB02-192  
16 cm / 6 1/4"



**Heymann**  
MAB02-193  
18.5 cm / 7 1/4"

**Allgemeines Instrumentarium . Instrumentation generale . Strumentario generale**  
**Nasenscheren, Episiotomiescheren**  
**Nasal Scissors, Episiotomy Scissors**  
**Tijeras nasales, Tijeras para episiotomía**  
**Ciseaux nasaux, Ciseaux à épisiotomie**  
**Forbici nasali, Forbici per episiotomia**



**Converse**  
MAB02-195  
10.5 cm / 4 1/4"  
stumpft  
blunt  
romo  
mousse  
smusso



**MAB02-196**  
10.5 cm / 4 1/4"  
spitz  
sharp  
agudo  
pointu  
appuntato



**Waldmann**  
MAB02-197  
18 cm / 7"  
eine Schneide  
gezahnt  
one toothed cutting  
edge  
una hoja dentada  
una lama dentelée  
una lama dentata



**Heymann**  
MAB02-1194  
18.5 cm / 7 1/4"  
eine Schneide gezahnt  
one toothed cutting  
edge  
una hoja dentada  
una lama denetelée  
una lama dentata



**Braun-Stadler**  
MAB02-198  
14.5 cm / 5 3/4"



**Braun-Stadler**  
MAB02-199  
22 cm / 8 3/4"



Allgemeines Instrumentarium . General Instrumentation . Instrumental general

Nabelschnurscheren

Umbilical Scissors  
Tijeras umbilicales  
Ciseaux pour le cordon ombilical  
Forbici ombelicali



Modell USA  
MAB02-200  
10.5 cm / 4 1/2"



Schuhmacher  
MAB 02-201  
16 cm / 6 1/4"

Allgemeines Instrumentarium . Instrumentation générale . Strumentario generale

Zahnfleischeren, Chirurgische Scheren

Gum Scissors, Operating Scissors  
Tijeras para encías, Tijeras quirúrgicas  
Ciseaux à gencives, Ciseaux chirurgicaux  
Forbici per gengiva, Forbici per chirurgia



Goldmann-Fox

MAB 02-204  
13 cm / 5"  
eine Schneide gezahnt  
one toothed cutting edge  
una hoja dentada  
une lame dentelée  
una lama dentata

MAB02-205  
13 cm / 5"

MAB 02-206 MAB02-207  
12 cm / 4 3/4" 12 cm / 4 3/4"

Wagner



Busch  
MAB02-202  
16 cm / 6 1/4"



Busch  
MAB 02-203  
16 cm / 6 1/4"

eine Schneide gezahnt  
one toothed cutting edge  
una hoja dentada  
une lame dentelée  
una lama dentata

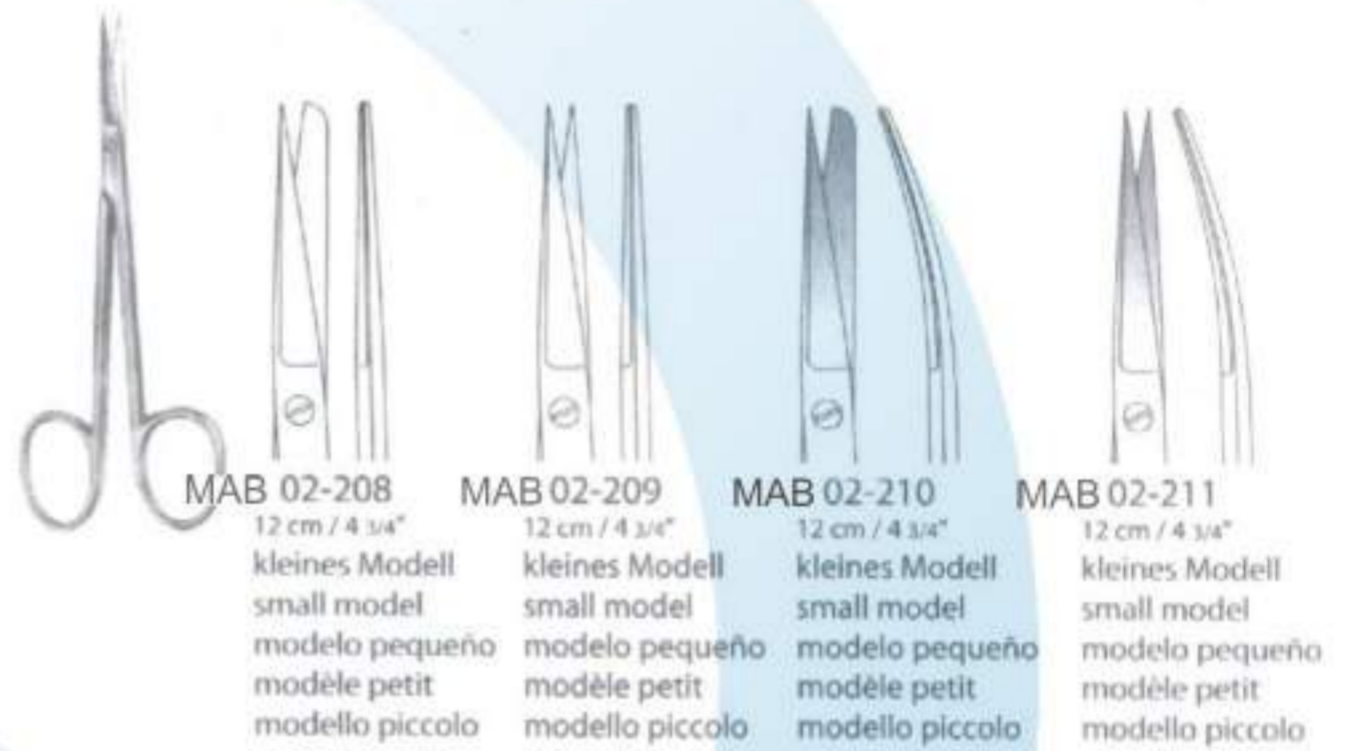

MAB 02-208  
12 cm / 4 3/4"  
kleines Modell  
small model  
modelo pequeño  
modèle petit  
modello piccolo

MAB 02-209  
12 cm / 4 3/4"  
kleines Modell  
small model  
modelo pequeño  
modèle petit  
modello piccolo

MAB 02-210  
12 cm / 4 3/4"  
kleines Modell  
small model  
modelo pequeño  
modèle petit  
modello piccolo

MAB 02-211  
12 cm / 4 3/4"  
kleines Modell  
small model  
modelo pequeño  
modèle petit  
modello piccolo

Allgemeines Instrumentarium . General Instrumentation . Instrumental general

Zahnfleischeren, Präparierscheren, Chirurgische Scheren

Gum Scissors, Dissecting Scissors, Operating Scissors  
Tijeras para encías, Tijeras de disección, Tijeras quirúrgicas  
Ciseaux à gencives, Ciseaux à dissection, Ciseaux chirurgicaux  
Forbici per gengiva, Forbici per dissezione, Forbici per chirurgia



La Grange  
S-förmig gebogen  
S-shaped  
forma S  
courbés en S  
curve in forma S

MAB02-212  
11.5 cm / 4 1/2"



fein  
delicate  
fino  
fin  
fino

MAB02-213 MAB02-214  
11.5 cm / 4 1/2" 11.5 cm / 4 1/2"

Allgemeines Instrumentarium . Instrumentation générale . Strumentario generale

Irischeren

Iris Scissors  
Tijeras para iridectomia  
Ciseaux à iridectomie  
Forbici per iridectomia



MAB02-219  
9 cm / 3 1/2"

MAB02-220  
10 cm / 4"

MAB02-221  
9 cm / 3 1/2"

MAB02-222  
10 cm / 4"



Locklin  
eine Schneide gezahnt  
one toothed cutting edge  
una hoja dentada  
une lame dentelée  
una lama dentata

MAB02-215  
16 cm / 6 1/4"



Locklin  
eine Schneide gezahnt  
one toothed cutting edge  
una hoja dentada  
une lame dentelée  
una lama dentata

MAB 02-216  
16 cm / 6 1/4"



MAB02-217 MAB02-218  
9 cm / 3 1/2" 9 cm / 3 1/2"

sehr fein  
very delicate  
muy fino  
très fine  
strafine



MAB02-223  
10 cm / 4"

extra flache Blätter  
extra flat blades  
hojas muy delgadas  
lames extrêmement plat  
con lame molto piatte



MAB02-224  
9 cm / 3 1/2"

Bonn



MAB02-225  
9 cm / 3 1/2"

Bonn



Allgemeines Instrumentarium . General Instrumentation . Instrumental general  
 Irisscheren, Sehenscheren  
 Iris Scissors, Tendon Scissors  
 Tijeras para iridectomía, Tijeras para tendones  
 Ciseaux à iridectomie, Ciseaux à ténotomie  
 Forbici per iridectomia, Forbici per tenotomia



Allgemeines Instrumentarium . Instrumentation générale . Strumentario generale  
 Strabismusscheren  
 Strabismus Scissors  
 Tijeras para estrabismo  
 Ciseaux à strabisme  
 Forbici per strabismo

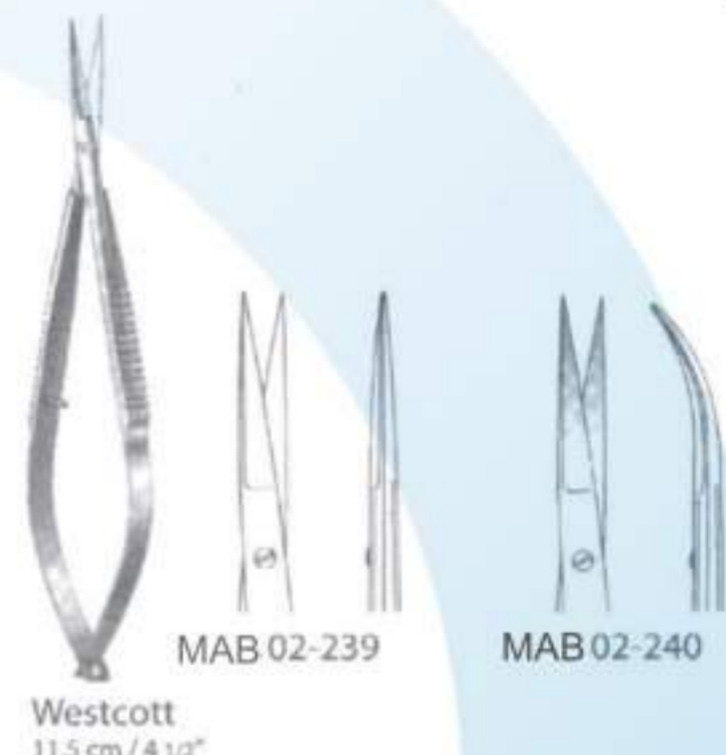

Allgemeines Instrumentarium . General Instrumentation . Instrumental general  
 Mikroscheren  
 Micro Scissors  
 Micro Tijeras  
 Micro- Ciseaux  
 Micro-Forbici



Stahl . Steel . Acero . Acier . Acciaio
15 cm / 6" MAB02-241 MAB02-242 MAB02-243 MAB02-244
Titan 1) . Titanium 1) . Titanio 1) . Titane 1) . Tatanio 1)
15 cm / 6" MAB02-245 MAB02-246 MAB02-247 MAB02-248
Stahl . Steel . Acero . Acier . Acciaio
18 cm / 7" MAB02-249 MAB02-250 MAB02-251 MAB02-252
Titan 1) . Titanium 1) . Titanio 1) . Titane 1) . Tatanio 1)
18 cm / 7" MAB02-253 MAB02-254 MAB02-255 MAB02-256
Stahl . Steel . Acero . Acier . Acciaio
21 cm / 8" MAB02-257 MAB02-258 MAB02-259 MAB02-260
Titan 1) . Titanium 1) . Titanio 1) . Titane 1) . Tatanio 1)
21 cm / 8" MAB02-261 MAB02-262 MAB02-263 MAB02-264
Stahl . Steel . Acero . Acier . Acciaio
23 cm / 9" MAB02-265 MAB02-266 MAB02-267 MAB02-268

1)  
 diamantierte Schneiden  
 diamond coated cutting edges  
 filos diamantados  
 lames diamantées  
 fini di diamante

Allgemeines Instrumentarium . General Instrumentation . Instrumental general  
 Mikroscheren  
 Micro Scissors  
 Micro Tijeras  
 Micro- Ciseaux  
 Micro-Forbici

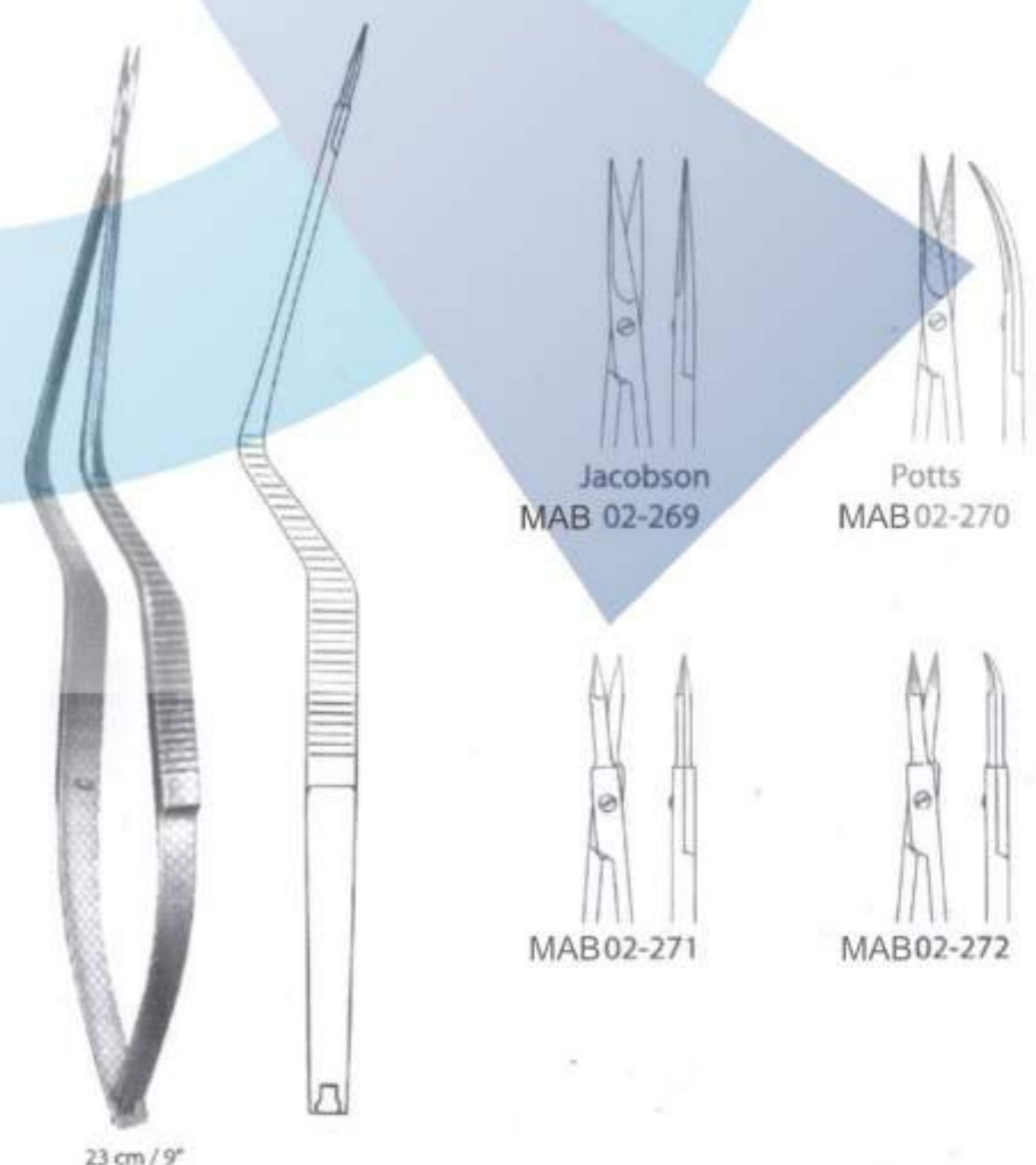



Allgemeines Instrumentarium . General Instrumentation . Instrumental general  
 Mikroschere  
 Micro Scissors  
 Micro Tijeras  
 Micro-Ciseaux  
 Micro-Forbici



Allgemeines Instrumentarium . Instrumentation générale . Strumentario generale  
 Mikroschere, Mikro-Präparierschere  
 Micro Scissors, Micro Dissecting Scissors  
 Micro Tijeras, Micro Tijeras de disección  
 Micro-Ciseaux, Micro-Ciseaux à dissection  
 Micro-Forbici, Micro-Forbici per dissezione



Allgemeines Instrumentarium . General Instrumentation . Instrumental general  
 Mikroschere  
 Micro Scissors  
 Micro Tijeras  
 Micro-Ciseaux  
 Micro-Forbici

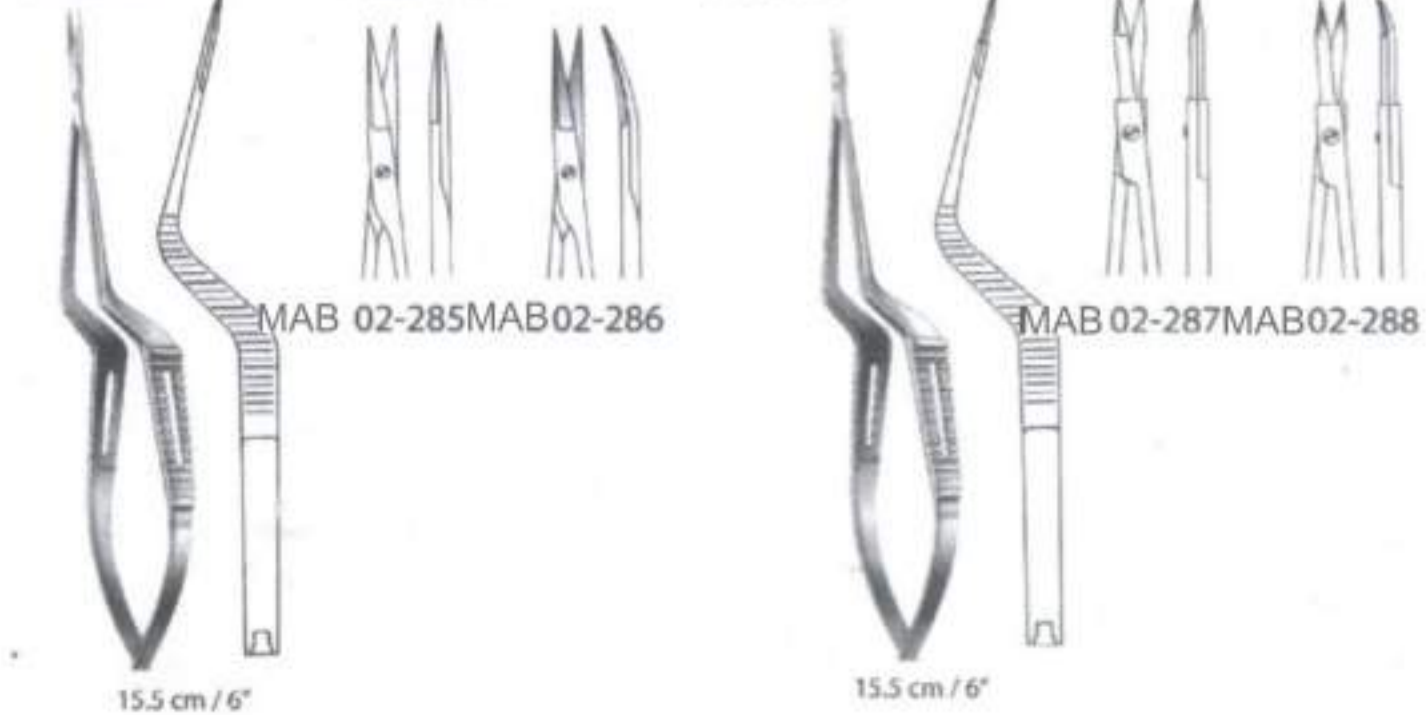
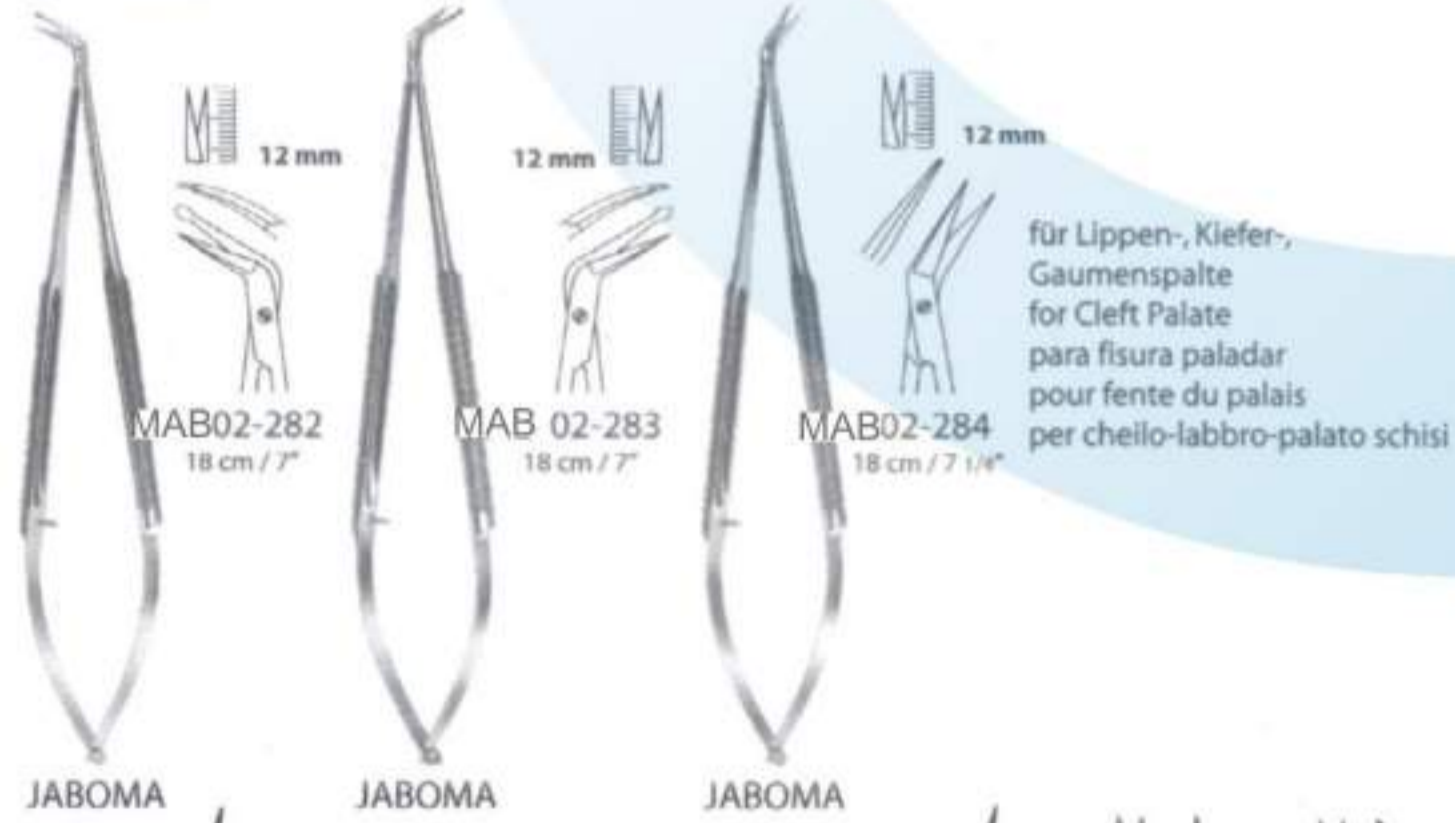

Allgemeines Instrumentarium . Instrumentation générale . Strumentario generale  
 Darmschere  
 Enterotomy Scissors  
 Tijeras para intestino  
 Ciseaux-entérotomes  
 Forbici per enterotomia

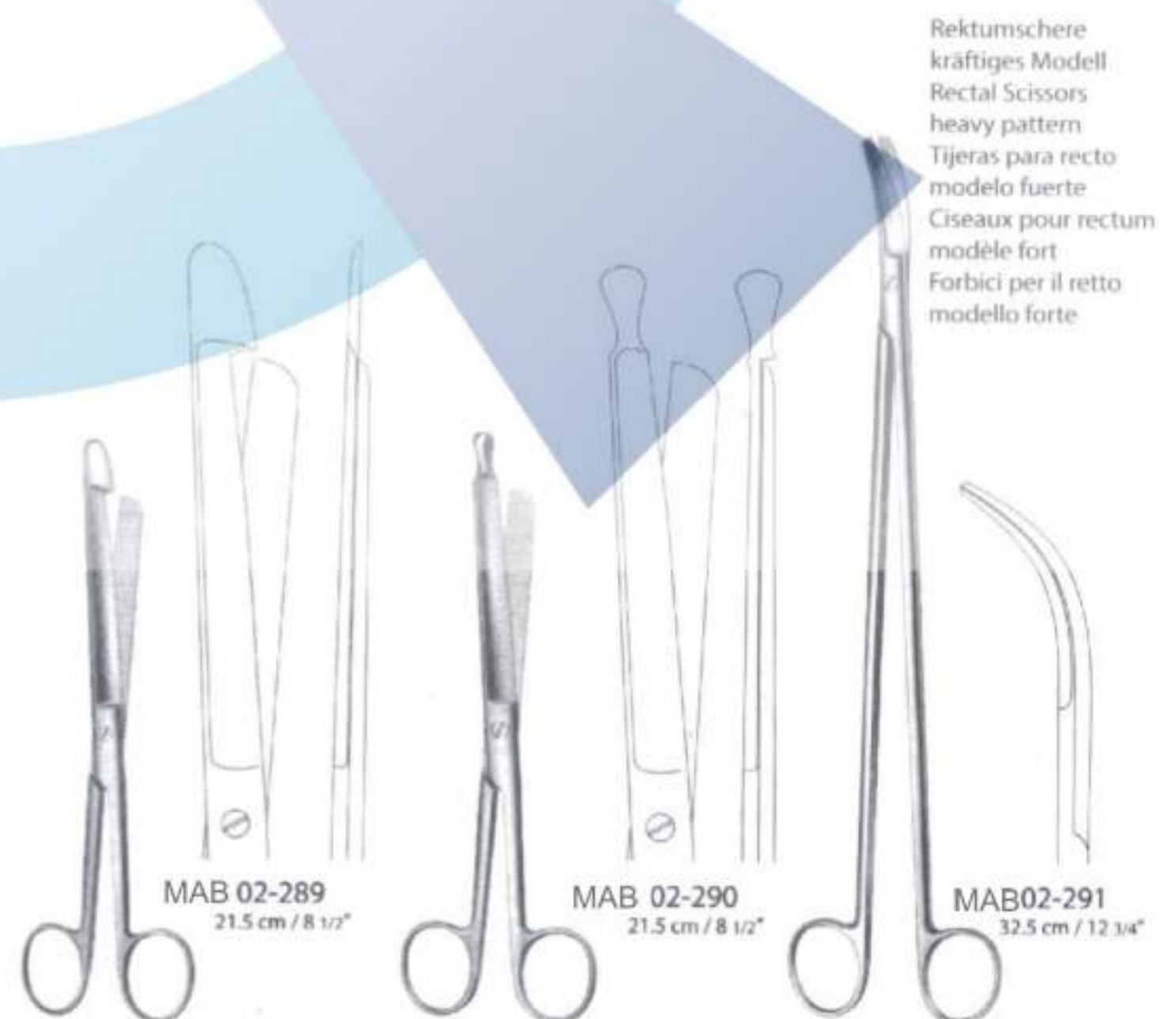



Allgemeines Instrumentarium . General Instrumentation . Instrumental general

Präparierscheren, Face-lift Scheren  
 Dissecting Scissors, Face-lift Scissors  
 Tijeras de disección, Tijeras para Face-lift  
 Ciseaux à dissection, Ciseaux pour Face-lift  
 Forbici per dissezione, Forbici per Face-lift

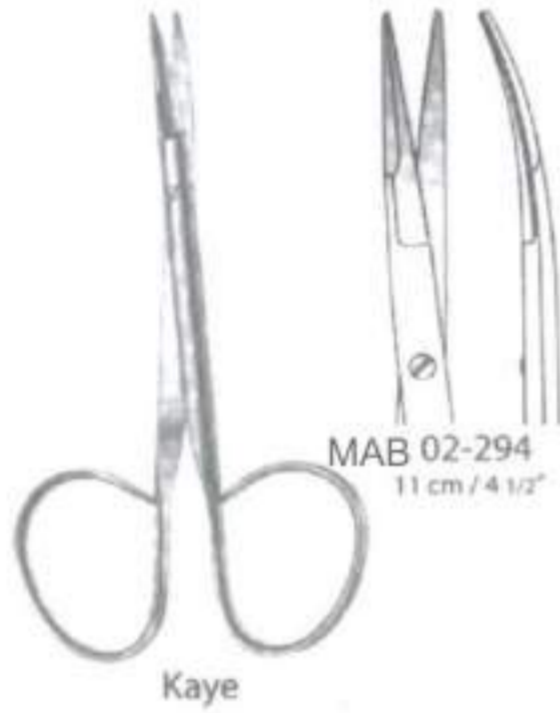

Allgemeines Instrumentarium . Instrumentation générale . Strumentario generale

Fadenscheren  
 Stitch Scissors  
 Tijeras para hilos  
 Ciseaux à ligatures  
 Forbici per legature

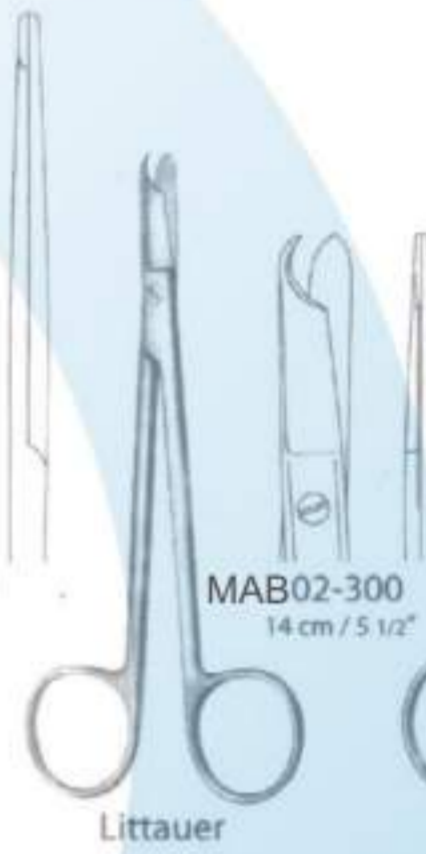

Allgemeines Instrumentarium . General Instrumentation . Instrumental general

Drahtscheren  
 Wire cutting Scissors  
 Tijeras para alambre  
 Cisailles à fils  
 Forbici per filo metallico

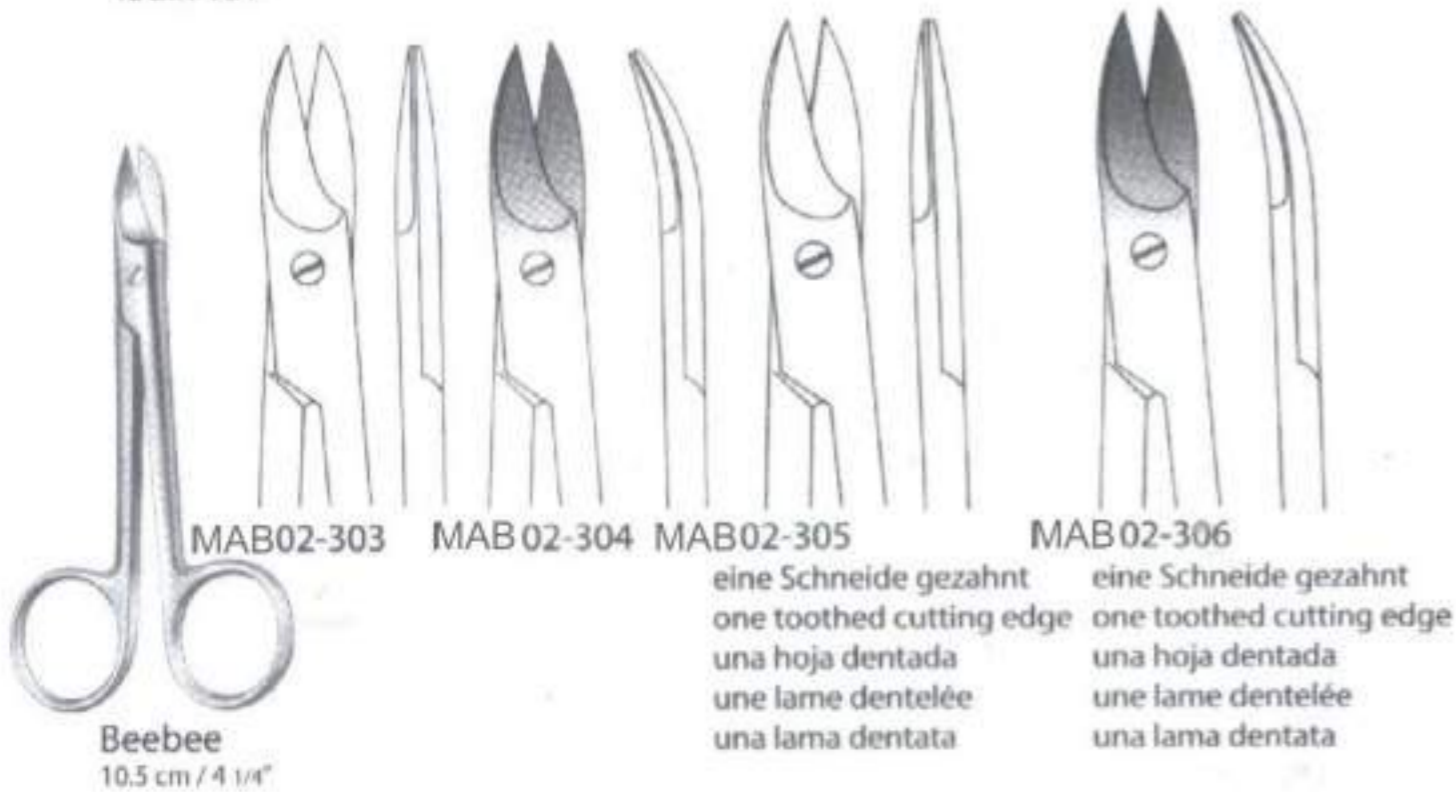

Allgemeines Instrumentarium . Instrumentation générale . Strumentario generale

Highmed-Präparierscheren  
 Highmed Dissecting Scissors  
 Highmed Tijeras de disección  
 Highmed Ciseaux à dissection  
 Highmed Forbici per dissezione



schlankes Modell  
slender pattern  
with special cutting edge  
modelo delgado  
con filo especial  
modèle gracile  
avec affûtage spéciale  
modello delicato  
con affilatura speciale





**TC GOLD**

TC-GOLD Scheren  
 TC-GOLD Scissors  
 TC-GOLD Tijeras  
 TC-GOLD Ciseaux  
 TC-GOLD Forbici

Allgemeines Instrumentarium . Instrumentation générale . Strumentario generale  
 Chirurgische Scheren  
 Operating Scissors  
 Tijeras quirúrgicas  
 Ciseaux chirurgicaux  
 Forbici per chirurgia  
**TC GOLD**

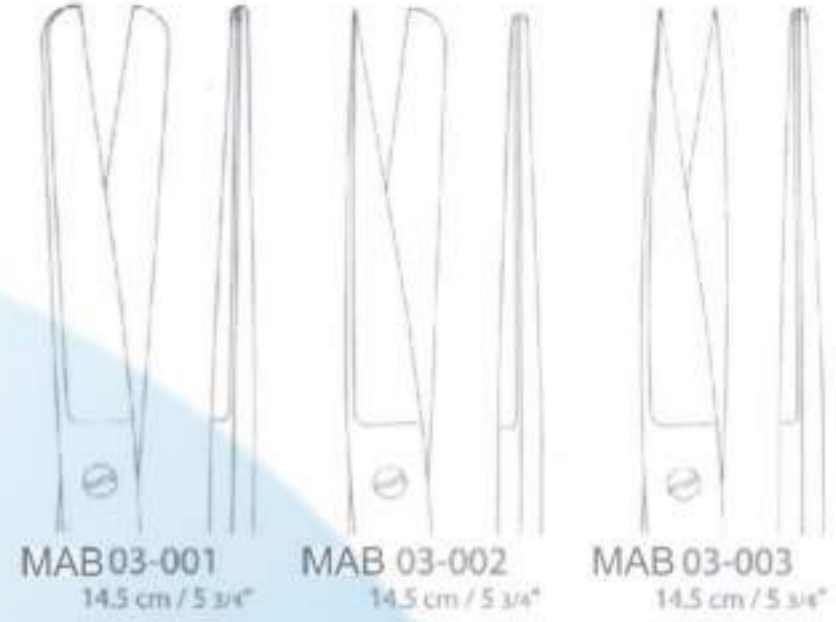

MAB03-001 14.5 cm / 5 3/4"  
 MAB03-002 14.5 cm / 5 3/4"  
 MAB03-003 14.5 cm / 5 3/4"



MAB03-004 14.5 cm / 5 3/4"  
 MAB03-005 14.5 cm / 5 3/4"  
 MAB03-006 14.5 cm / 5 3/4"

Allgemeines Instrumentarium . General Instrumentation . Instrumental general  
 Chirurgische Scheren  
 Operating Scissors  
 Tijeras quirúrgicas  
 Ciseaux chirurgicaux  
 Forbici per chirurgia

**TC GOLD**

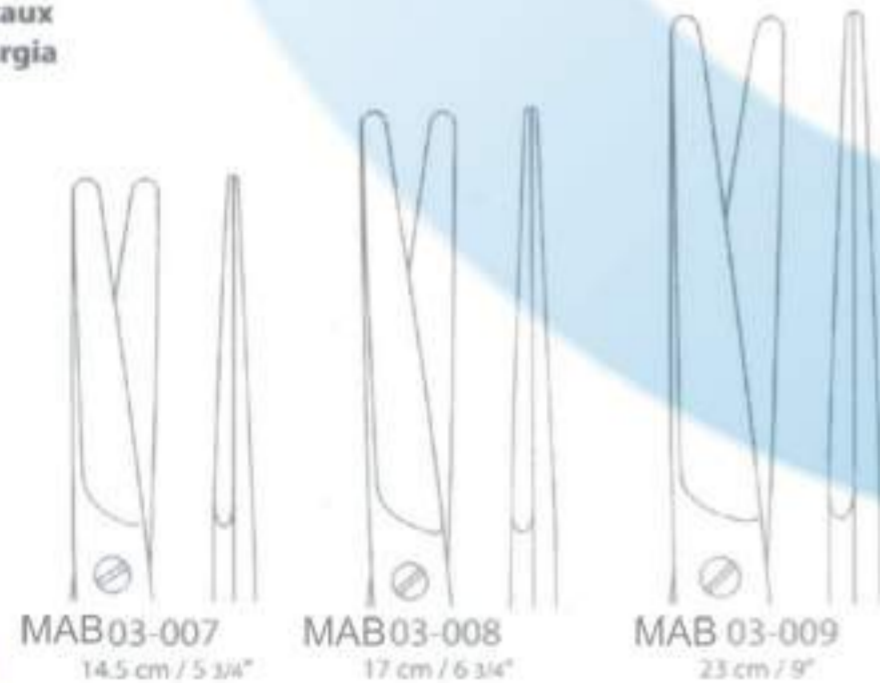

MAB03-007 14.5 cm / 5 3/4"  
 MAB03-008 17 cm / 6 3/4"  
 MAB03-009 23 cm / 9"

Mayo



MAB03-010 14.5 cm / 5 3/4"  
 MAB03-011 17 cm / 6 3/4"  
 MAB03-012 23 cm / 9"

Mayo

Allgemeines Instrumentarium . Instrumentation générale . Strumentario generale  
 Ligaturscheren  
 Ligature Scissors  
 Tijeras para ligaduras  
 Ciseaux pour ligatures  
 Forbici per lagature

**TC GOLD**



MAB03-013 14.5 cm / 5 3/4"  
 MAB03-014 18 cm / 7"  
 MAB03-015 20.5 cm / 8"  
 MAB03-016 23 cm / 9"  
 MAB03-017 25 cm / 9 3/4"

für Synthetik-Nahtmaterial, eine Schneide gezahnt  
 for synthetic suture material, one toothed cutting edge  
 para hilos de sutura sintéticos, una hoja dentada  
 pour matériel de suture synthétique, une lame dentelée  
 per materiale di sutura sintetico, una lama dentata

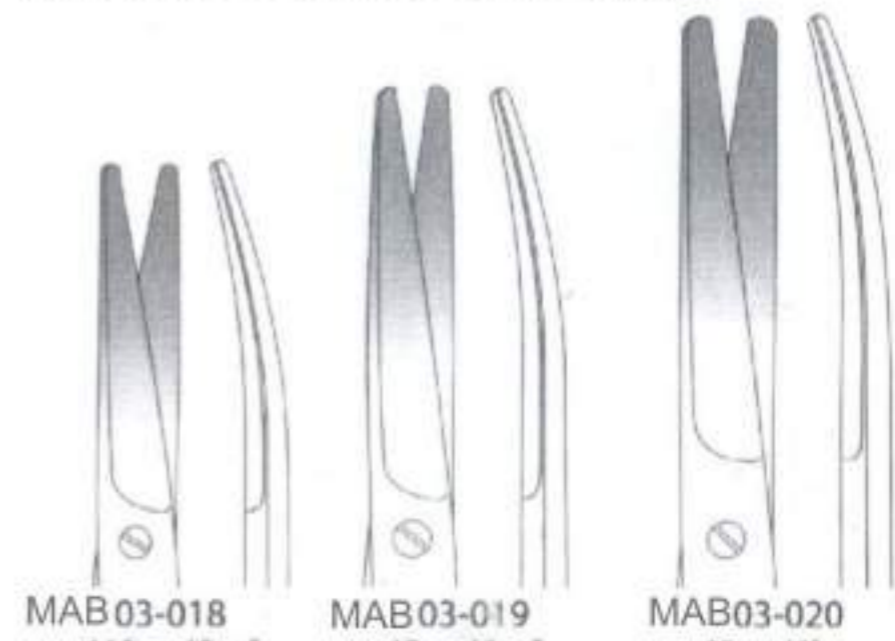

MAB03-018 14.5 cm / 5 3/4"  
 MAB03-019 17 cm / 6 3/4"  
 MAB03-020 23 cm / 9"

für Synthetik-Nahtmaterial, eine Schneide gezahnt  
 for synthetic suture material, one toothed cutting edge  
 para hilos de sutura sintéticos, una hoja dentada  
 pour matériel de suture synthétique, une lame dentelée  
 per materiale di sutura sintetico, una lama dentata



Allgemeines Instrumentarium . General Instrumentation . Instrumental general  
 Präparierscheren  
 Dissecting Scissors  
 Tijeras de disección  
 Ciseaux à dissection  
 Forbici per dissezione  
**TC GOLD**



Allgemeines Instrumentarium . Instrumentation générale . Instrumentario generale  
 Präparierscheren  
 Dissecting Scissors  
 Tijeras de disección  
 Ciseaux à dissection  
 Forbici per dissezione  
**TC GOLD**



Allgemeines Instrumentarium . General Instrumentation . Instrumental general  
 Präparierscheren  
 Dissecting Scissors  
 Tijeras de disección  
 Ciseaux à dissection  
 Forbici per dissezione  
**TC GOLD**

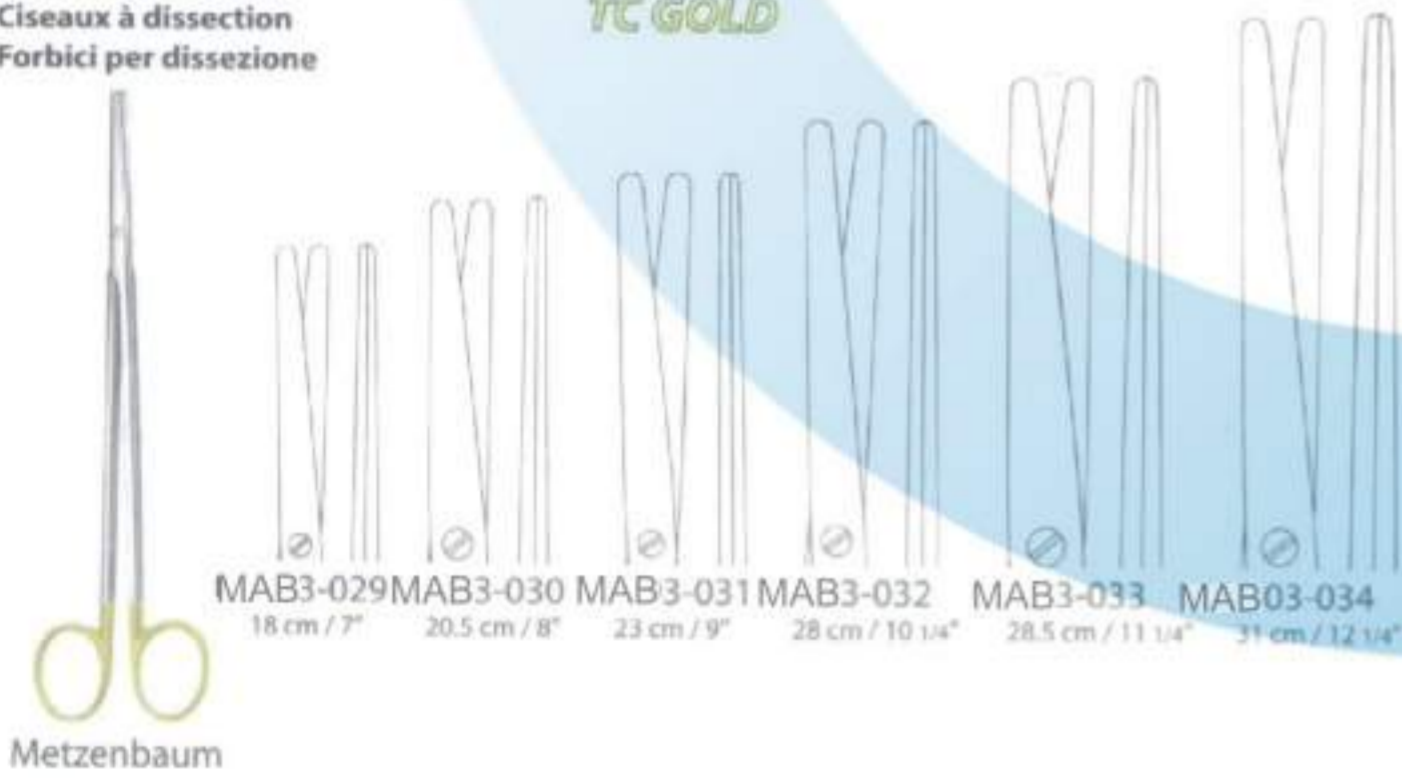

Allgemeines Instrumentarium . Instrumentation générale . Instrumentario generale  
 Präparierscheren  
 Dissecting Scissors  
 Tijeras de disección  
 Ciseaux à dissection  
 Forbici per dissezione  
**TC GOLD**

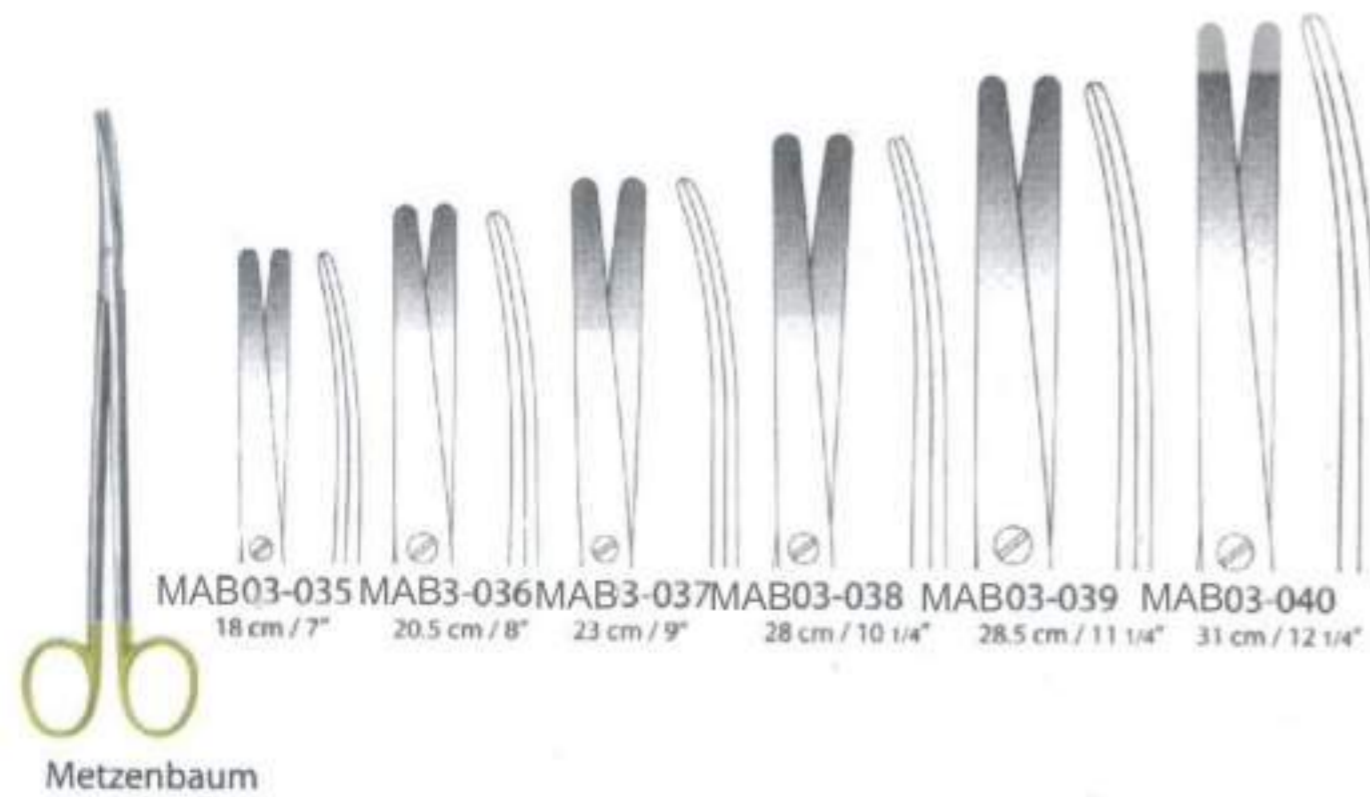
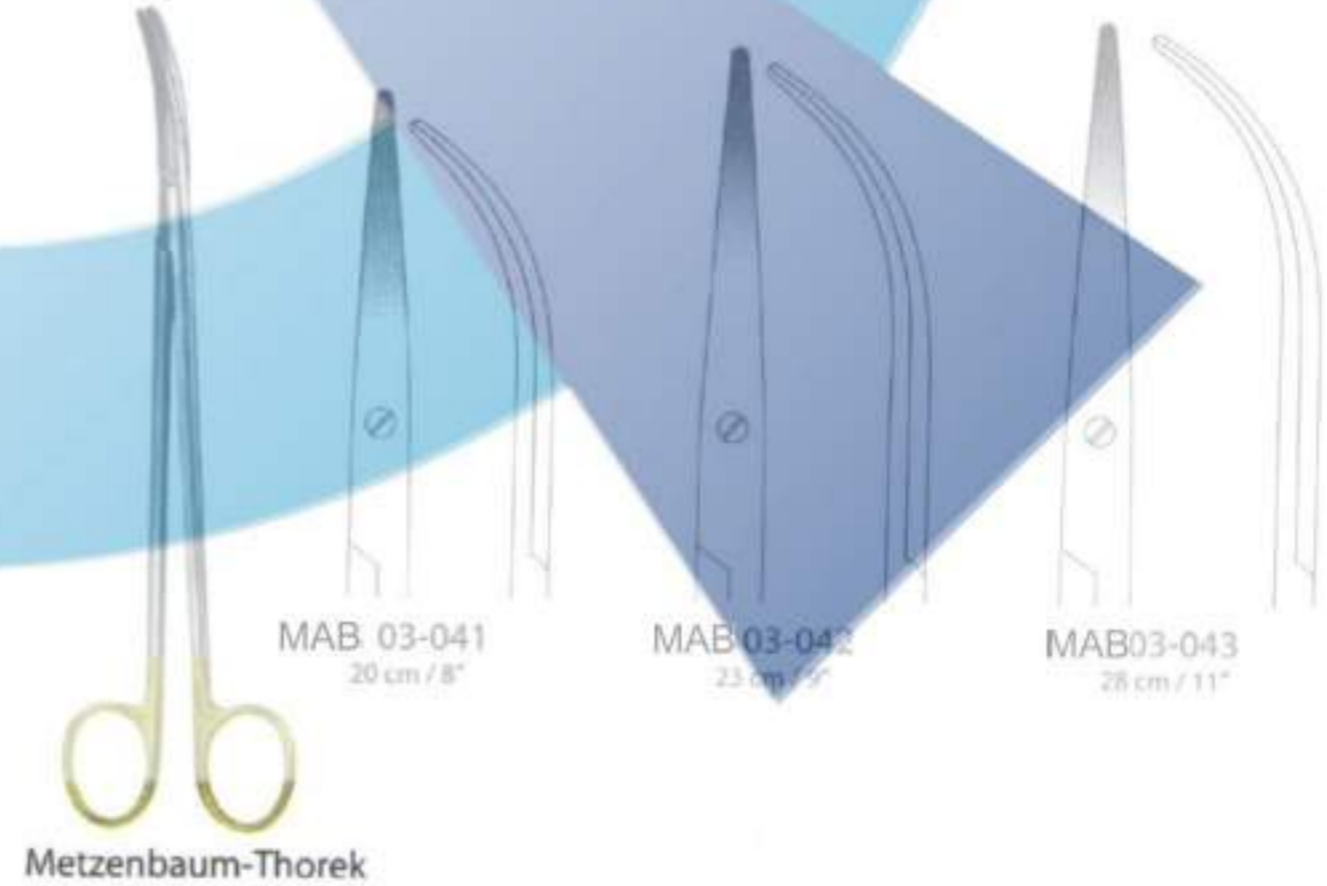



Allgemeines Instrumentarium . General Instrumentation . Instrumental general  
 Präparierscheren  
 Dissecting Scissors  
 Tijeras de disección  
 Ciseaux à dissection  
 Forbici per dissezione  
**TC GOLD**



MAB03-046 16 cm / 6 1/4"  
 MAB03-047 21 cm / 8 1/4"  
 MAB03-048 16 cm / 6 1/4"  
 MAB03-049 21 cm / 8 1/4"  
 MAB03-050 16 cm / 6 1/4"

Lexer  
 Lexer  
 Mayo-Lexer

Allgemeines Instrumentarium . Instrumentation générale . Instrumentario generale  
 Präparierscheren  
 Dissecting Scissors  
 Tijeras de disección  
 Ciseaux à dissection  
 Forbici per dissezione  
**TC GOLD**



MAB03-051 14.5 cm / 5 3/4"  
 MAB03-052 14.5 cm / 5 3/4"  
 MAB03-053 18 cm / 7"  
 MAB03-054 18 cm / 7"  
 MAB03-055 20.5 cm / 8"  
 MAB03-056 23 cm / 9"  
 MAB03-057 26 cm / 10 1/4"  
 MAB03-058 28.5 cm / 11 1/4"

Metzenbaum-Fino  
 schlankes Modell  
 slender pattern  
 modelo delgado  
 modèle gracile  
 modello delicato  
 Metzenbaum-Fino  
 schlankes Modell  
 slender pattern  
 modelo delgado  
 modèle gracile  
 modello delicato

Allgemeines Instrumentarium . General Instrumentation . Instrumental general  
 Präparierscheren  
 Dissecting Scissors  
 Tijeras de disección  
 Ciseaux à dissection  
 Forbici per dissezione  
**TC GOLD**

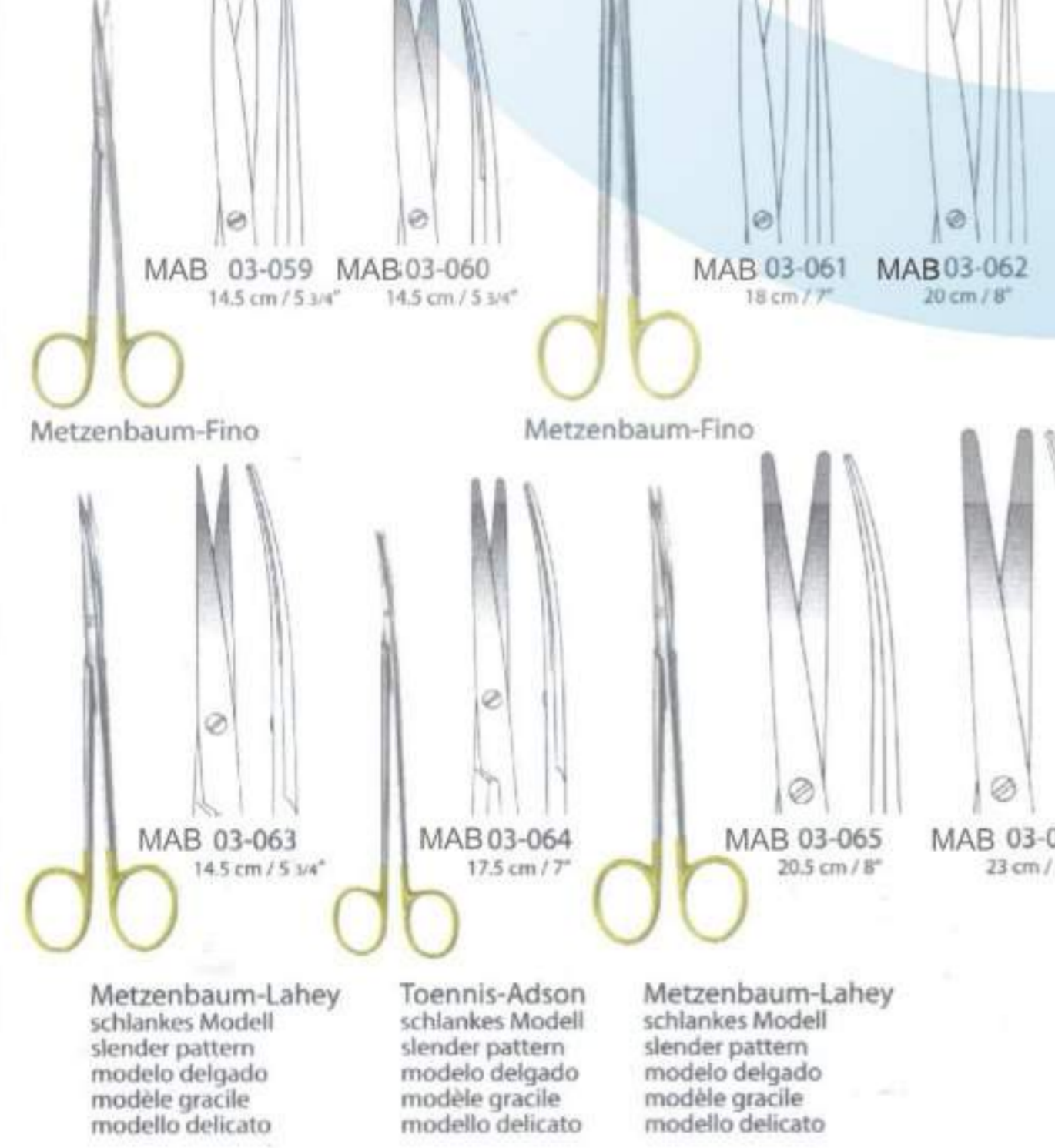

MAB03-059 14.5 cm / 5 3/4"  
 MAB03-060 14.5 cm / 5 3/4"  
 MAB03-061 18 cm / 7"  
 MAB03-062 20 cm / 8"  
 MAB03-063 14.5 cm / 5 3/4"  
 MAB03-064 17.5 cm / 7"  
 MAB03-065 20.5 cm / 8"  
 MAB03-066 23 cm / 9"

Metzenbaum-Fino  
 Metzenbaum-Fino  
 Metzenbaum-Lahey  
 schlankes Modell  
 slender pattern  
 modelo delgado  
 modèle gracile  
 modello delicato  
 Toennis-Adson  
 schlankes Modell  
 slender pattern  
 modelo delgado  
 modèle gracile  
 modello delicato  
 Metzenbaum-Lahey  
 schlankes Modell  
 slender pattern  
 modelo delgado  
 modèle gracile  
 modello delicato

Allgemeines Instrumentarium . Instrumentation générale . Strumentario generale  
 präparierscheren, Face-lift Scheren  
 Dissecting Scissors, Face-lift Scissors  
 Tijeras de disección, Tijeras para ace-lift  
 Ciseaux à dissection, Ciseaux pour Face-lift  
 Forbici per dissezione, Forbici per Face-lift  
**TC GOLD**



MAB03-067 18 cm / 7"  
 MAB03-068 20.5 cm / 8"  
 MAB03-069 23 cm / 9"  
 MAB03-070 20 cm / 8"  
 MAB03-071 23 cm / 9"  
 MAB03-072 17 cm / 6 3/4"

Metzenbaum-Fino  
 schlankes Modell  
 slender pattern  
 modelo delgado  
 modèle gracile  
 modello delicato  
 Metzenbaum-Fino  
 Gorney  
 eine Schneide gezahnt  
 one toothed cutting edge  
 una hoja dentada  
 une lame dentelée  
 una lama dentata  
 Rees  
 eine Schneide gezahnt  
 one toothed cutting edge  
 una hoja dentada  
 une lame dentelée  
 una lama dentata



Allgemeines Instrumentarium . General Instrumentation . Instrumental general

Uterusscheren  
Uterine Scissors  
Tijeras uterinas  
Ciseaux utérins  
Forbici uterini  
**TC GOLD**

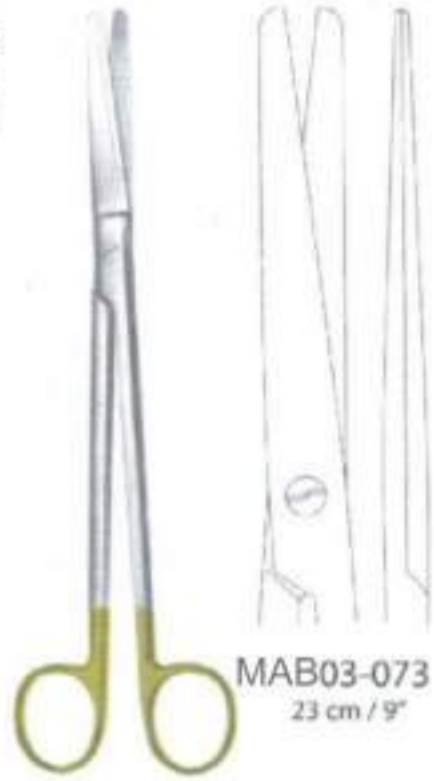

Sims



MAB03-074  
23 cm / 9"

Allgemeines Instrumentarium . General Instrumentation . Instrumental general

Zahnfleischeren, Irisscheren  
Gum Scissors, Iris Scissors  
Tijera para encías, Tijeras para iridectomia  
Ciseaux à gencives, Ciseaux à iridectomie  
Forbici per gengiva, Forbici per iridectomia  
**TC GOLD**



Goldmann-Fox



Goldmann-Fox

Allgemeines Instrumentarium . Instrumentation générale . Instrumentario generale

Hysterektomiescheren  
Hysterectomy Scissors  
Tijeras para histerectomia  
Ciseaux à hystérectomie  
Forbici per isterectomia



Parametrium  
kräftiges Modell  
heavy pattern  
modelo fuerto  
modèle fort  
modello forte



MAB03-075  
23 cm / 9"

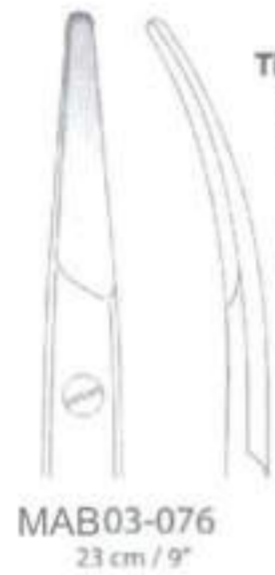

MAB03-076  
23 cm / 9"



MAB03-079  
11.5 cm / 4 1/2"



MAB03-080  
11.5 cm / 4 1/2"

Allgemeines Instrumentarium . Instrumentation générale . Strumentario generale

Winkelscheren  
Angled Scissors  
Tijeras acodadas  
Ciseaux coudés  
Forbici angolati  
**TC GOLD**



DeBakey



MAB03-081  
19 cm / 7 1/2"  
25°



MAB03-082  
18.5 cm / 7 1/4"  
45°



MAB03-083  
18 cm / 7"  
60°



MAB03-084  
23 cm / 9"  
25°



MAB03-085  
23 cm / 9"  
45°

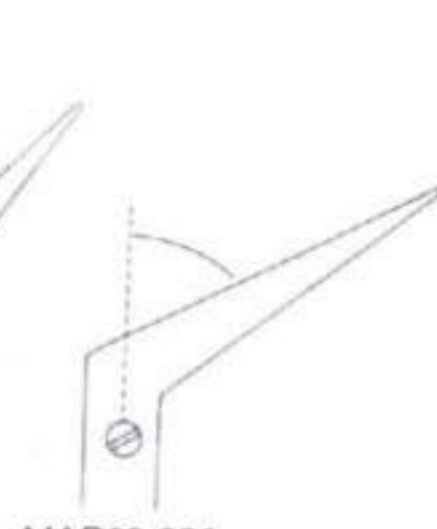

MAB03-086  
22 cm / 8 3/4"  
60°

Allgemeines Instrumentarium . General Instrumentation . Instrumental general

Winkelscheren, Präparierscheren, Chirurgische Scheren  
Angled Scissors, Dissecting Scissors, Operating Scissors  
Tijeras acodadas, Tijeras de disección, Tijeras quirúrgicas  
Ciseaux coudés, Ciseaux à dissection, Ciseaux chirurgicaux  
Forbici angolati, Forbici per dissezione, Forbici per chirurgia  
**TC GOLD**



MAB03-087  
13 cm / 4 1/2"



MAB03-088  
12 cm / 5"

Ragnell



Kelly



MAB03-089  
16 cm / 6 1/4"



MAB03-090  
16 cm / 6 1/4"



Allgemeines Instrumentarium . Instrumentation générale . Strumentario generale  
 Tonsillenscheren, Zahnfleischscheren  
 Tonsil Scissors, Gum Scissors  
 Tijeras para amígdalas, Tijeras para encías  
 Ciseaux pour les amygdales, Ciseaux à gencives  
 Forbici per tonsille, Forbici per gengiva

**TC GOLD**



**MAB03-091**  
 12.5 cm / 5"  
 Drahtschere  
 eine Schneide gezahnt  
 Wire Cutting Scissors  
 one toothed cutting edge  
 Tijeras para alambre  
 una hoja dentada  
 Ciseaux à fils  
 une lame dentelée  
 Forbici per fili  
 una lama dentata

Universal



**MAB03-092**  
 17.5 cm / 7"  
 eine Schneide gezahnt  
 S-förmig gebogen  
 one toothed cutting edge  
 S-shaped  
 una hoja dentada  
 forma S  
 une lame dentelée  
 courbés en S  
 una lama dentata  
 curve in forma S



**MAB03-093**  
 16 cm / 6 1/4"  
 eine Schneide gezahnt  
 one toothed cutting edge  
 una hoja dentada  
 une lame dentelée  
 una lama dentata

Locklin



**MAB03-094**  
 16 cm / 6 1/4"  
 eine Schneide gezahnt  
 one toothed cutting edge  
 una hoja dentada  
 une lame dentelée  
 una lama dentata

Locklin

## Pinzetten Forceps Pinzas Pincers Pinze



**MAB 04**

Allgemeines Instrumentarium . General Instrumentation . Instrumental general

Anatomische Pinzetten  
 Dressing Forceps  
 Pinzas de disección  
 Pincers à dissection  
 Pinze per dissezione

Allgemeines Instrumentarium . Instrumentation générale . Instrumentario general

Anatomische Pinzetten  
 Dressing Forceps  
 Pinzas de disección  
 Pincers à dissection  
 Pinze per dissezione



Standardmodell  
 standard pattern  
 modelo estándar  
 modèle standard  
 modello standard

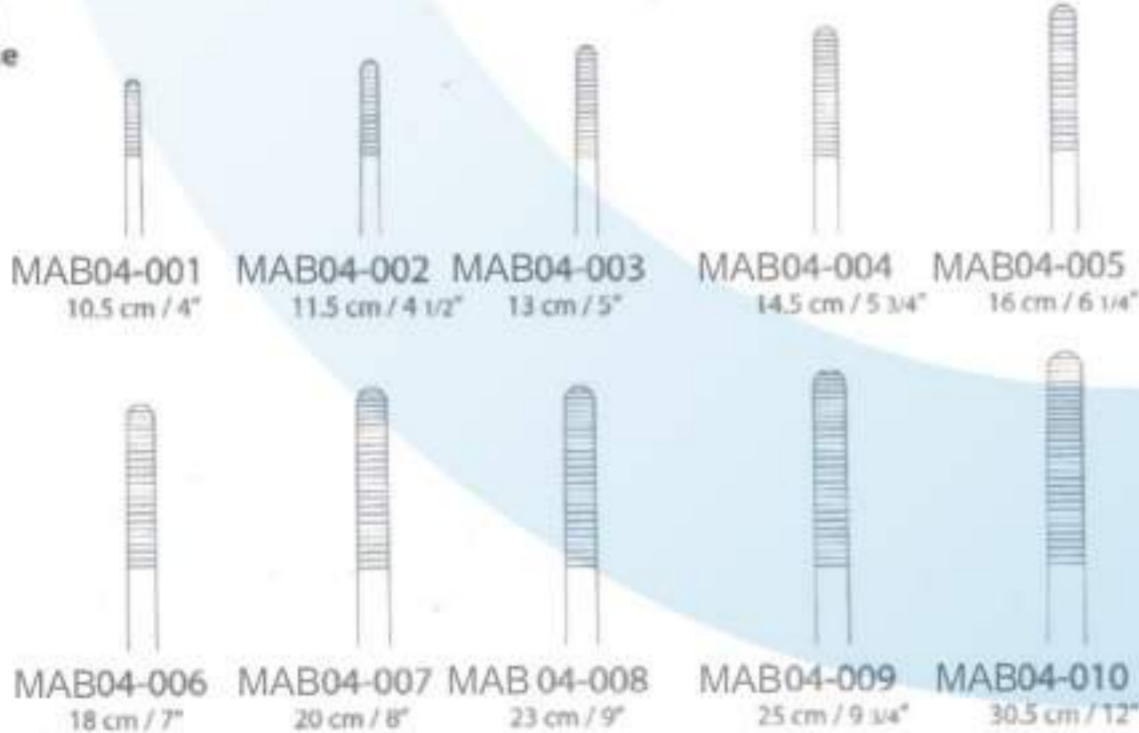

schlankes Modell  
 slender pattern  
 modelo delgado  
 modèle gracile  
 modello delicato

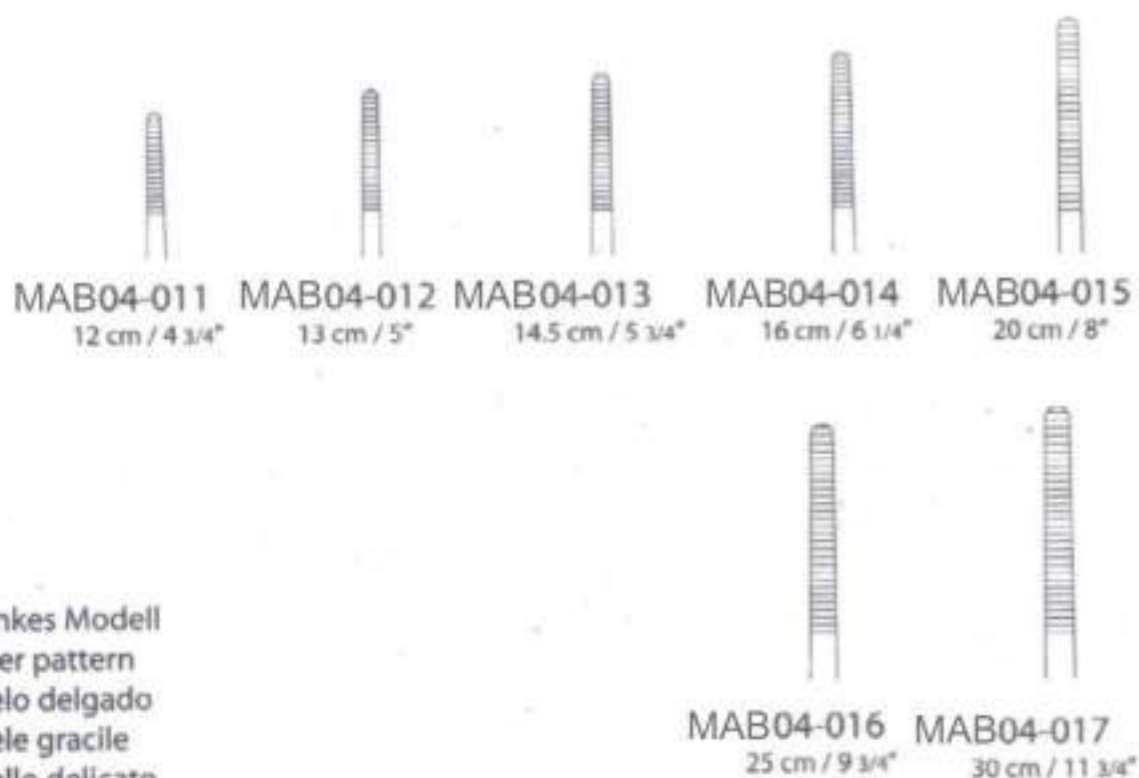

Mini-Adson

**MAB04-021**  
 12 cm / 4 3/4"



Adson

**S 04-022**  
 12 cm / 4 3/4"

**MAB04-023**  
 15 cm / 6"



McIndoe

**MAB04-024**  
 15 cm / 6"



Allgemeines Instrumentarium . General Instrumentation . Instrumental general

Anatomische Pinzetten  
Dressing Forceps  
Pinzas de disección  
Pincers à dissection  
Pinze per dissezione



MAB4-025 20 cm / 8"  
MAB4-026 12.5 cm / 5"  
MAB4-027 15 cm / 6"

Semken

Waugh

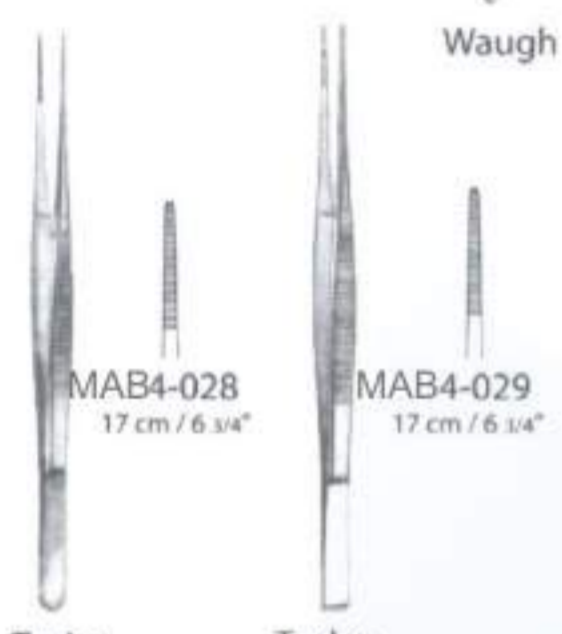

MAB4-028 17 cm / 6 3/4"  
MAB4-029 17 cm / 6 3/4"

Taylor

Taylor mit Schaberende with dissector end con rascador à rugine con estremità a forma di raschino



MAB4-030 18.5 cm / 7 1/4"

Taylor mit Schaberende with dissector end con rascador à rugine con estremità a forma di raschino

Allgemeines Instrumentarium . Instrumentation générale . Strumentario generale

Anatomische Mikropinzetten, Anatomische Pinzetten  
Micro Dressing Forceps, Dressing Forceps  
Micro Pinzas de disección, Pinzas de disección  
Micro-Pincers à dissection, Pincers à dissection  
Micro-Pinze per dissezione, Pinze per dissezione



S 04-031 15.5 cm / 6"  
Spitze tips puntas pointe punta 0.6 mm  
MAB4-032 15.5 cm / 6"  
Spitze tips puntas pointe punta 0.8 mm  
MAB4-033 15.5 cm / 6"  
Spitze tips puntas pointe punta 1.0 mm  
MAB4-034 17.5 cm / 7"  
MAB4-035 17.5 cm / 7"

Gerald



MAB4-036 17.5 cm / 7"  
MAB4-037 17.5 cm / 7"  
MAB4-038 18 cm / 7"  
MAB4-039 21 cm / 8 1/4"  
MAB4-040 24.5 cm / 9 3/4"

Cushing

Potts-Smith

Allgemeines Instrumentarium . General Instrumentation . Instrumental general

Chirurgische Pinzetten, Anatomische Pinzetten  
Dissecting Forceps, Dressing Forceps  
Pinzas de disección con dientes, Pinzas de disección  
Pincers à dissection à griffes, Pincers à dissection  
Pinze per dissezione con denti, Pinze per dissezione

TC GOLD

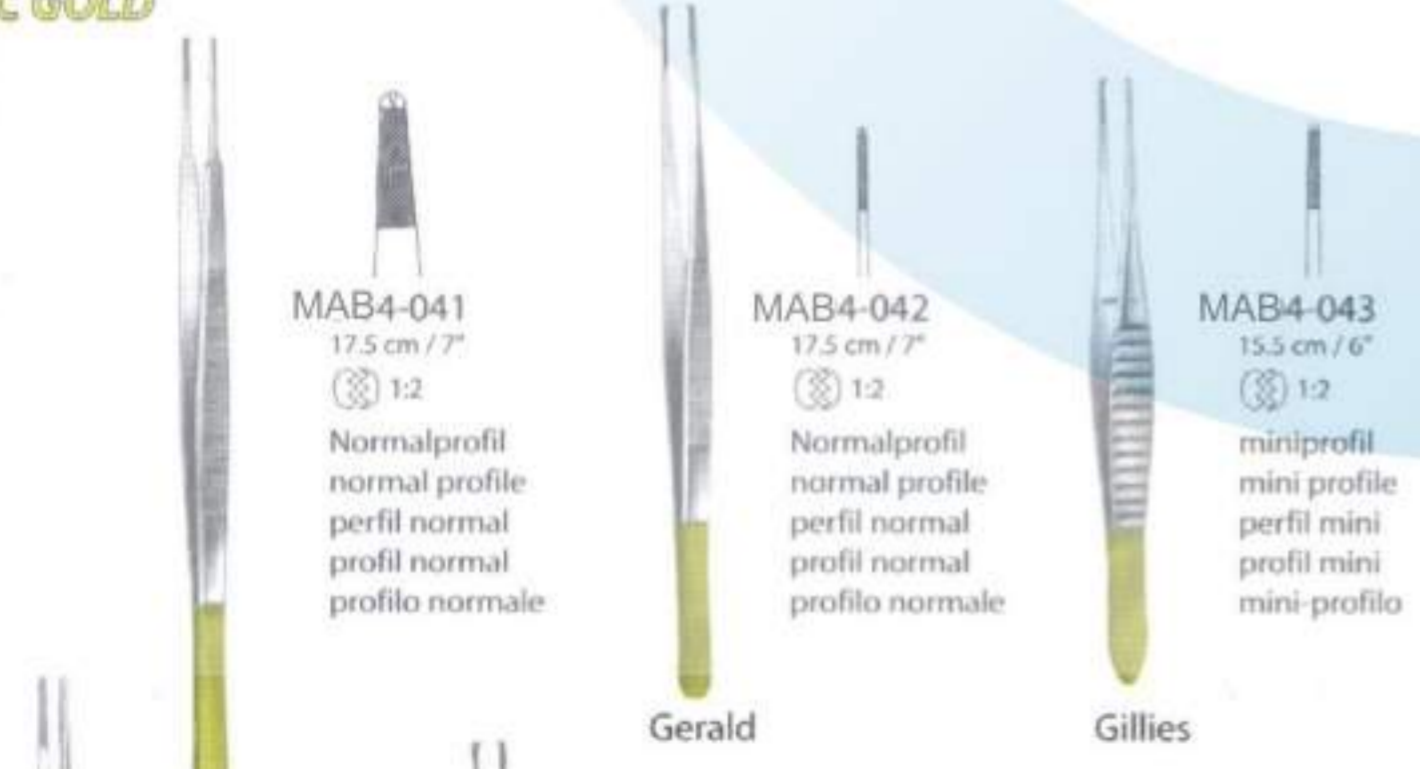

MAB4-041 17.5 cm / 7"  
Normalprofil normal profile perfil normal profilo normale  
MAB4-042 17.5 cm / 7"  
Normalprofil normal profile perfil normal profilo normale  
MAB4-043 15.5 cm / 6"  
miniprofil mini profile perfil mini profilo normale

Gerald

Gillies

Allgemeines Instrumentarium . Instrumentation générale . Strumentario generale

Chirurgische Pinzetten, Anatomische Pinzetten  
Dissecting Forceps, Dressing Forceps  
Pinzas de disección con dientes, Pinzas de disección  
Pincers à dissection à griffes, Pincers à dissection  
Pinze per dissezione con denti, Pinze per dissezione

TC GOLD

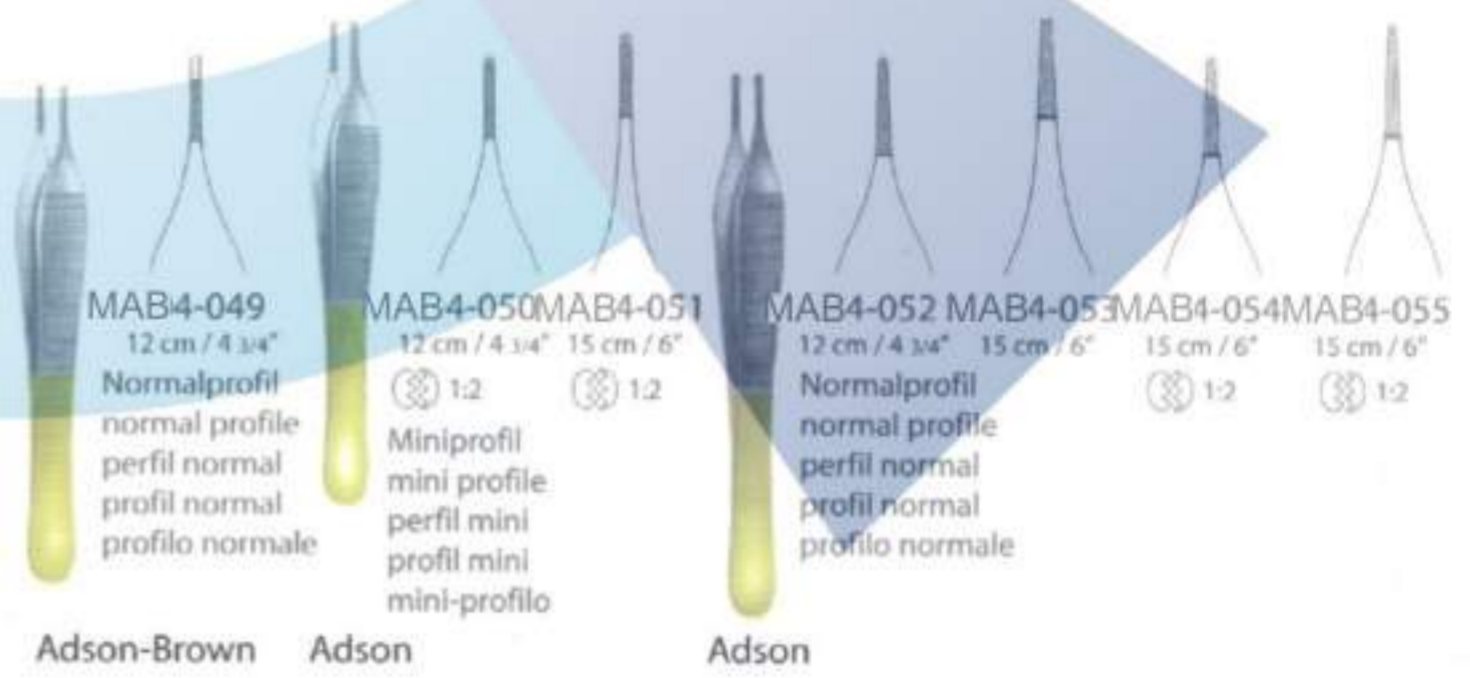

MAB4-049 12 cm / 4 3/4"  
Normalprofil normal profile perfil normal profilo normale  
MAB4-050 12 cm / 4 3/4"  
Miniprofil mini profile perfil mini profilo normale  
MAB4-051 15 cm / 6"  
Normalprofil normal profile perfil normal profilo normale  
MAB4-052 12 cm / 4 3/4"  
Normalprofil normal profile perfil normal profilo normale  
MAB4-053 15 cm / 6"  
Normalprofil normal profile perfil normal profilo normale  
MAB4-054 15 cm / 6"  
Normalprofil normal profile perfil normal profilo normale  
MAB4-055 15 cm / 6"  
Normalprofil normal profile perfil normal profilo normale

Adson-Brown Adson

Adson

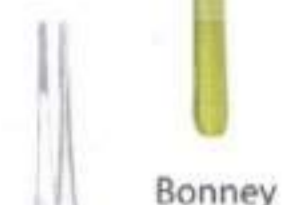

Bonney



MAB4-044 15 cm / 6"  
miniprofil mini profile perfil mini profilo normale

McIndoe



Semken

MAB4-045 15.5 cm / 6"  
Normalprofil normal profile perfil normal profilo normale  
MAB4-046 17.5 cm / 7"  
Normalprofil normal profile perfil normal profilo normale  
MAB4-047 15.5 cm / 6"  
miniprofil mini profile perfil mini profilo normale  
MAB4-048 17.5 cm / 7"  
miniprofil mini profile perfil mini profilo normale



Cushing



Cushing

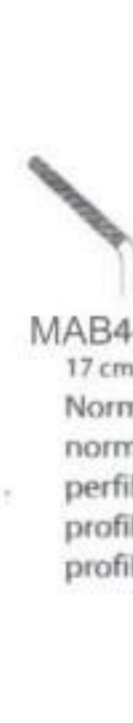

MAB4-057 17 cm / 6 3/4"  
Normalprofil normal profile perfil normal profilo normale



Cushing-Taylor

MAB4-058 18.5 cm / 7 1/4"  
Normalprofil normal profile perfil normal profilo normale



Allgemeines Instrumentarium . General Instrumentation . Instrumental general  
 Anatomische Pinzetten, Chirurgische Pinzetten  
 Dressing Forceps, Dissecting Forceps  
 Pinzas de disección, Pinzas de disección con dientes  
 Pincés à dissection, Pincés à dissection à griffes  
 Pinze per dissezione, Pinze per dissezione con denti

**TC GOLD**

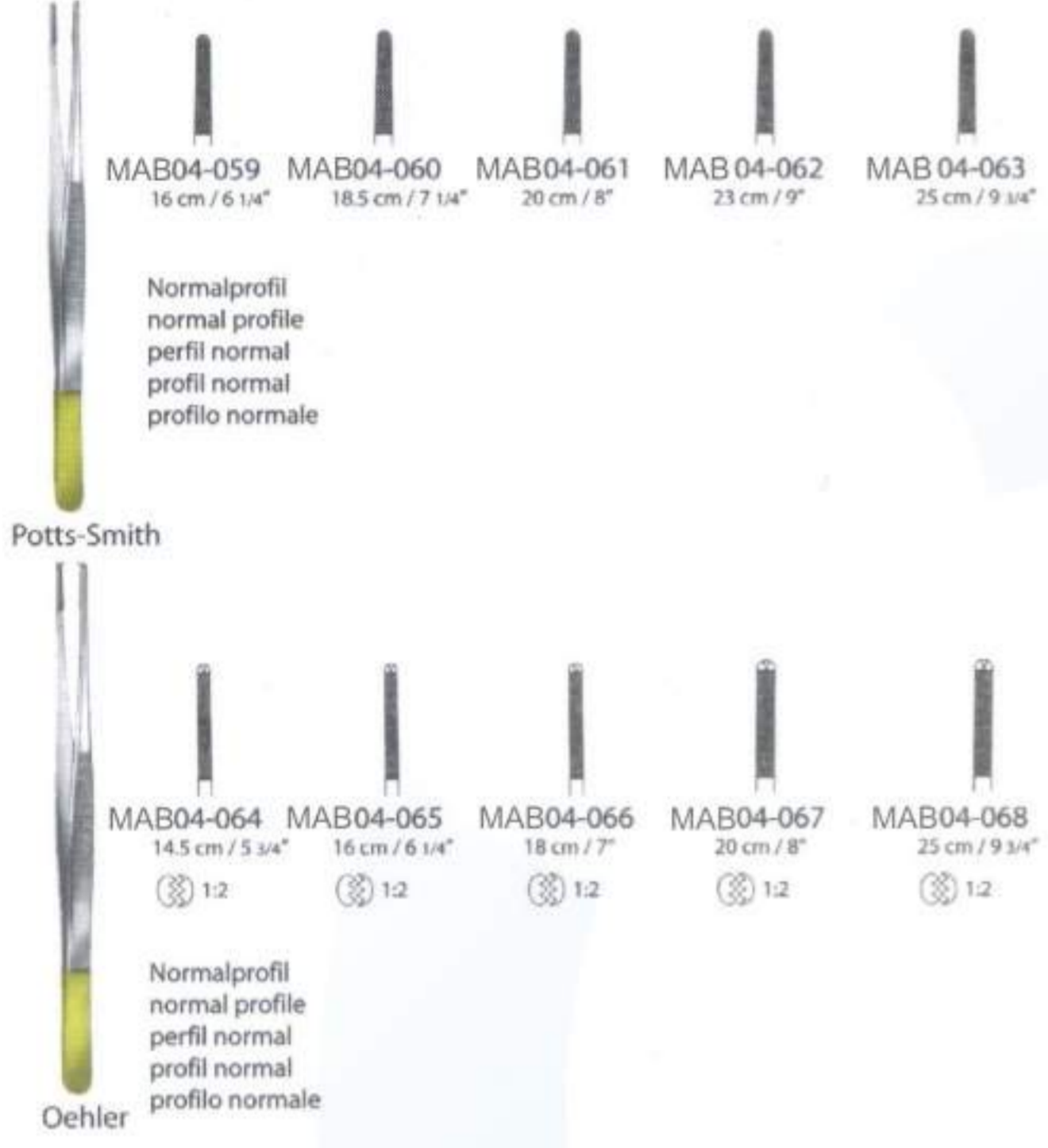

Allgemeines Instrumentarium . Instrumentation générale . Strumentario generale  
 Anatomische Pinzetten, Atraumatische Pinzetten  
 Dressing Forceps, Atraumatic Dressing Forceps  
 Pinzas de disección, Pinzas de disección atraumática  
 Pincés à dissection, Pincés atraumatiques à dissection  
 Pinze per dissezione, Pinze atraumatiche

**TC GOLD**

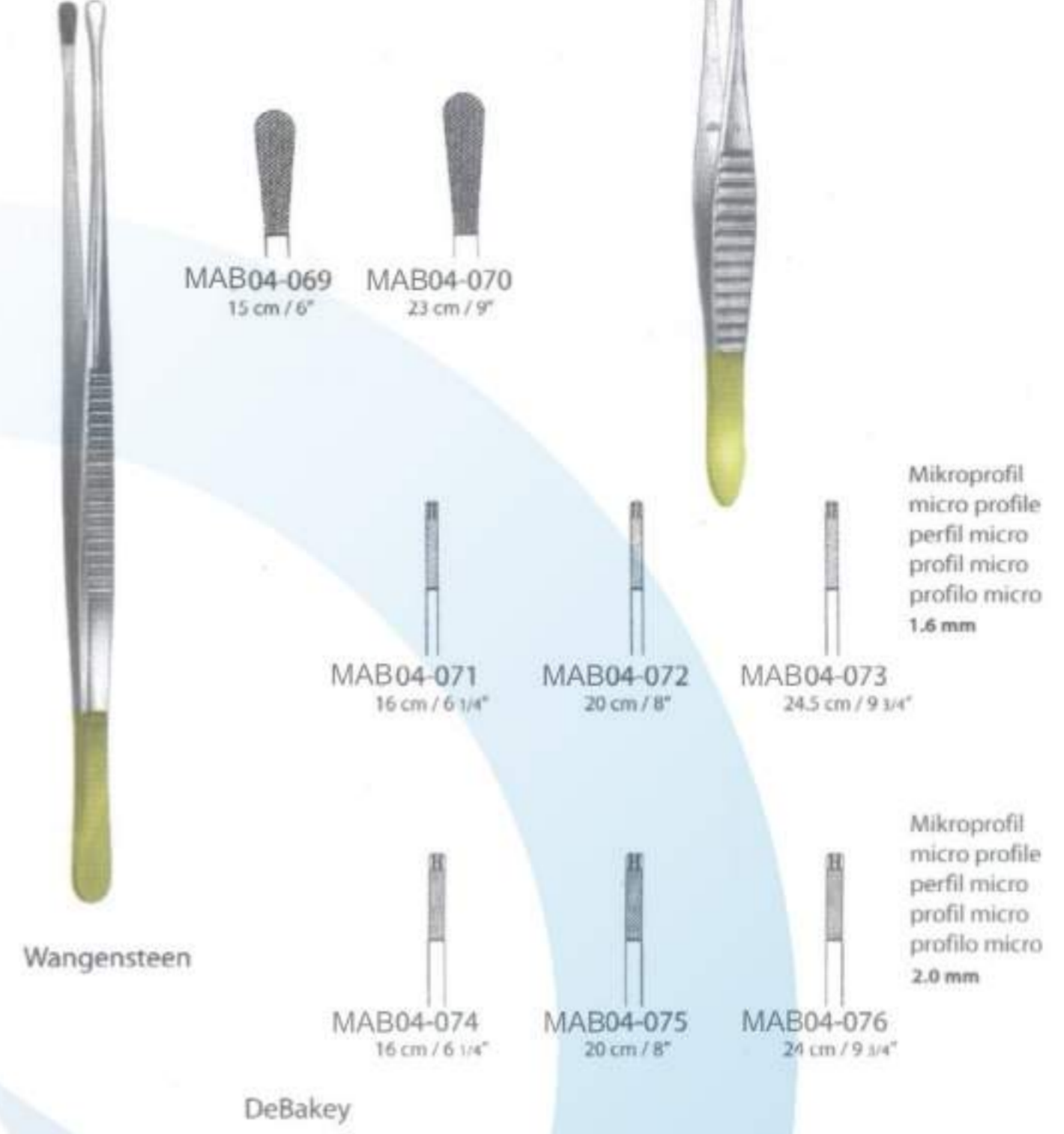

Allgemeines Instrumentarium . General Instrumentation . Instrumental general  
 Anatomische, Pinzetten, Chirurgische Pinzetten  
 Atraumatic Dressing Forceps, Dissecting Forceps  
 Pinzas de disección, Pinzas de disección con dientes  
 Pincés à dissection, Pincés à dissection à griffes  
 Pinze per dissezione, Pinze per dissezione con denti

**TC GOLD**

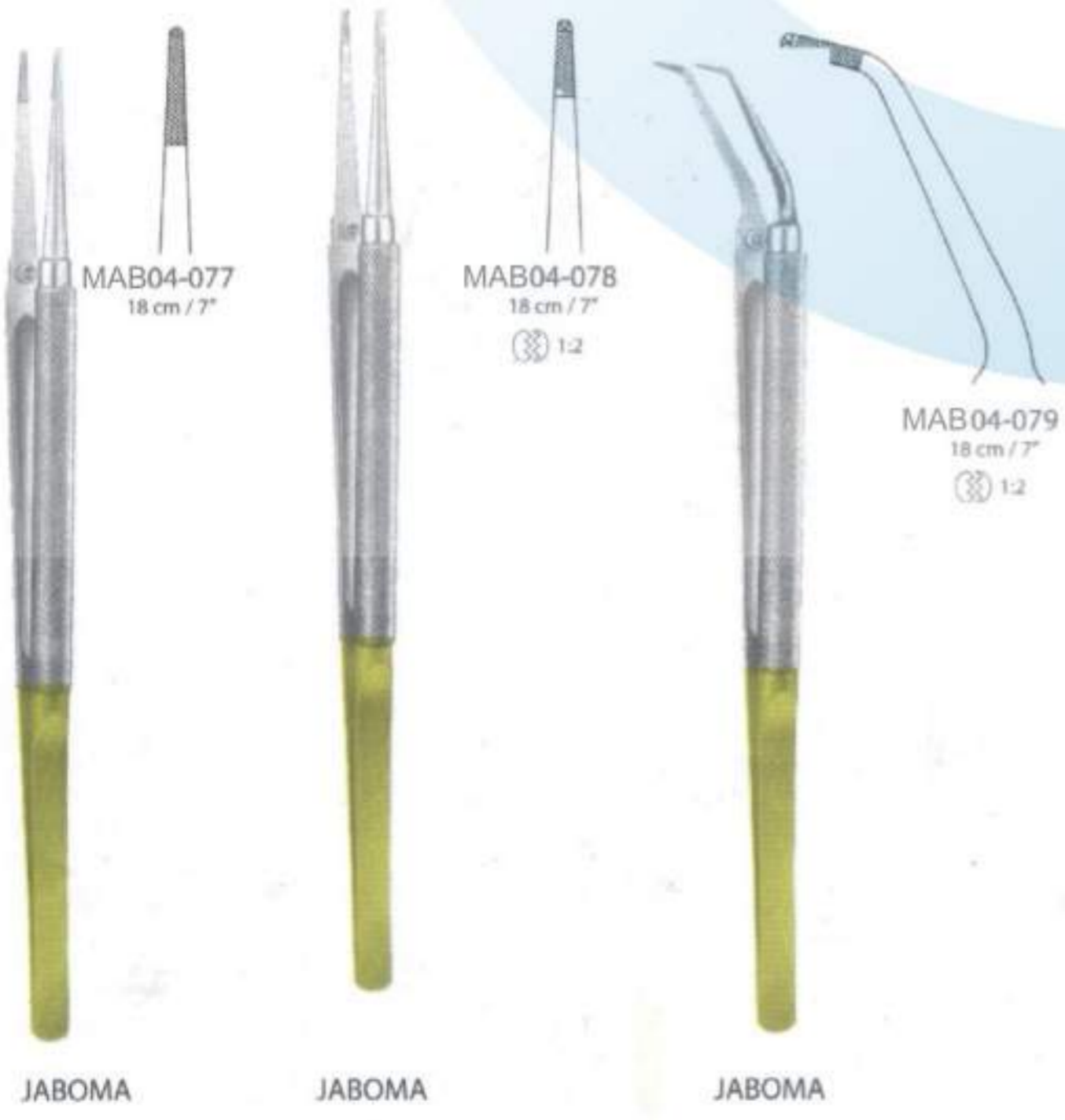

Allgemeines Instrumentarium . Instrumentation générale . Strumentario generale  
 Atraumatische Pinzetten  
 Atraumatic Dressing Forceps  
 Pinzas de disección atraumática  
 Pincés atraumatiques à dissection  
 Pinze atraumatiche

**Atrauma  
 ium**

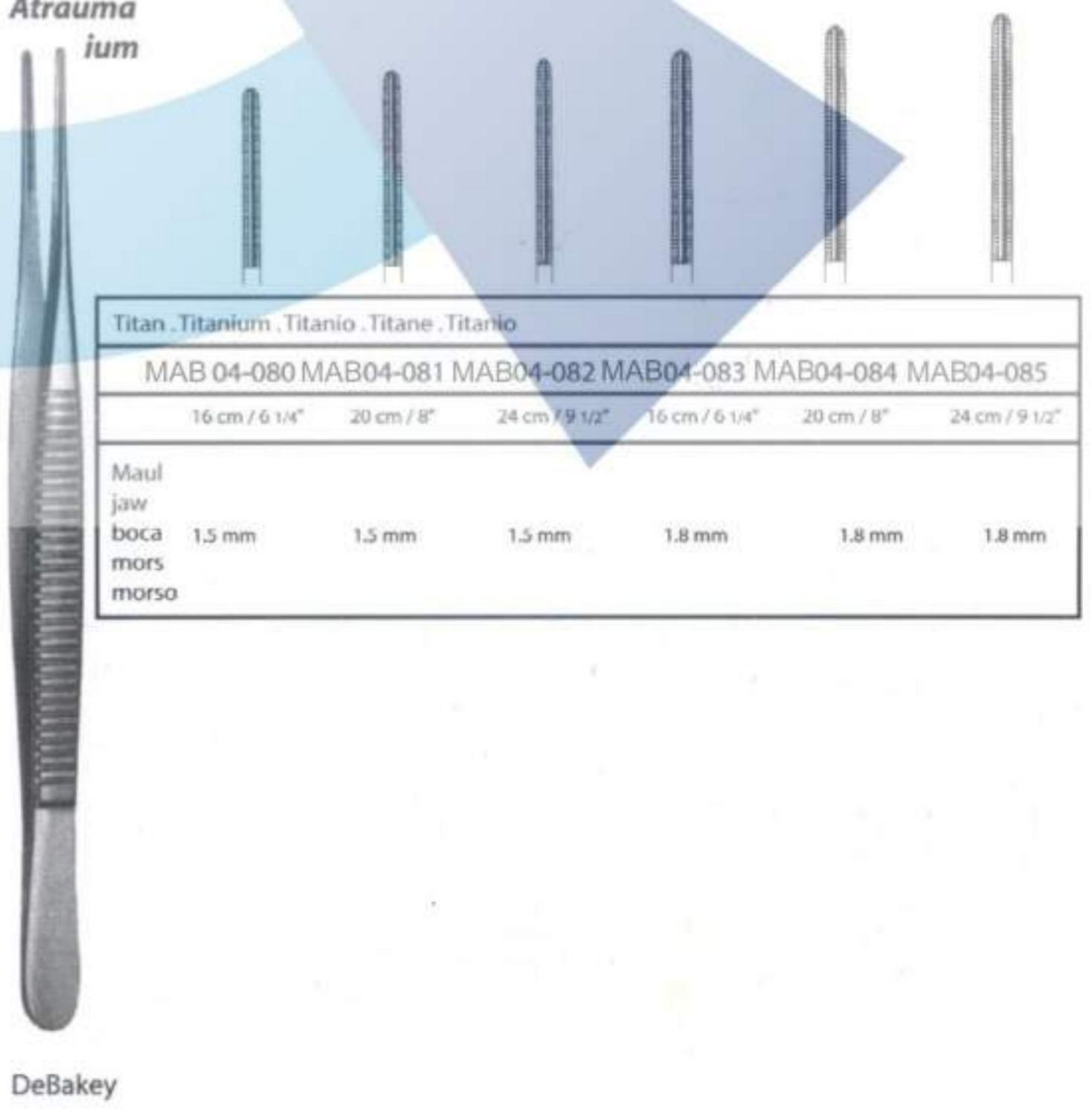



Allgemeines Instrumentarium . General Instrumentation . Instrumental general

Chirurgische Pinzetten  
Dissecting Forceps  
Pinzas de disección con dientes  
Pinces à dissection à griffes  
Pinze per dissezione con denti

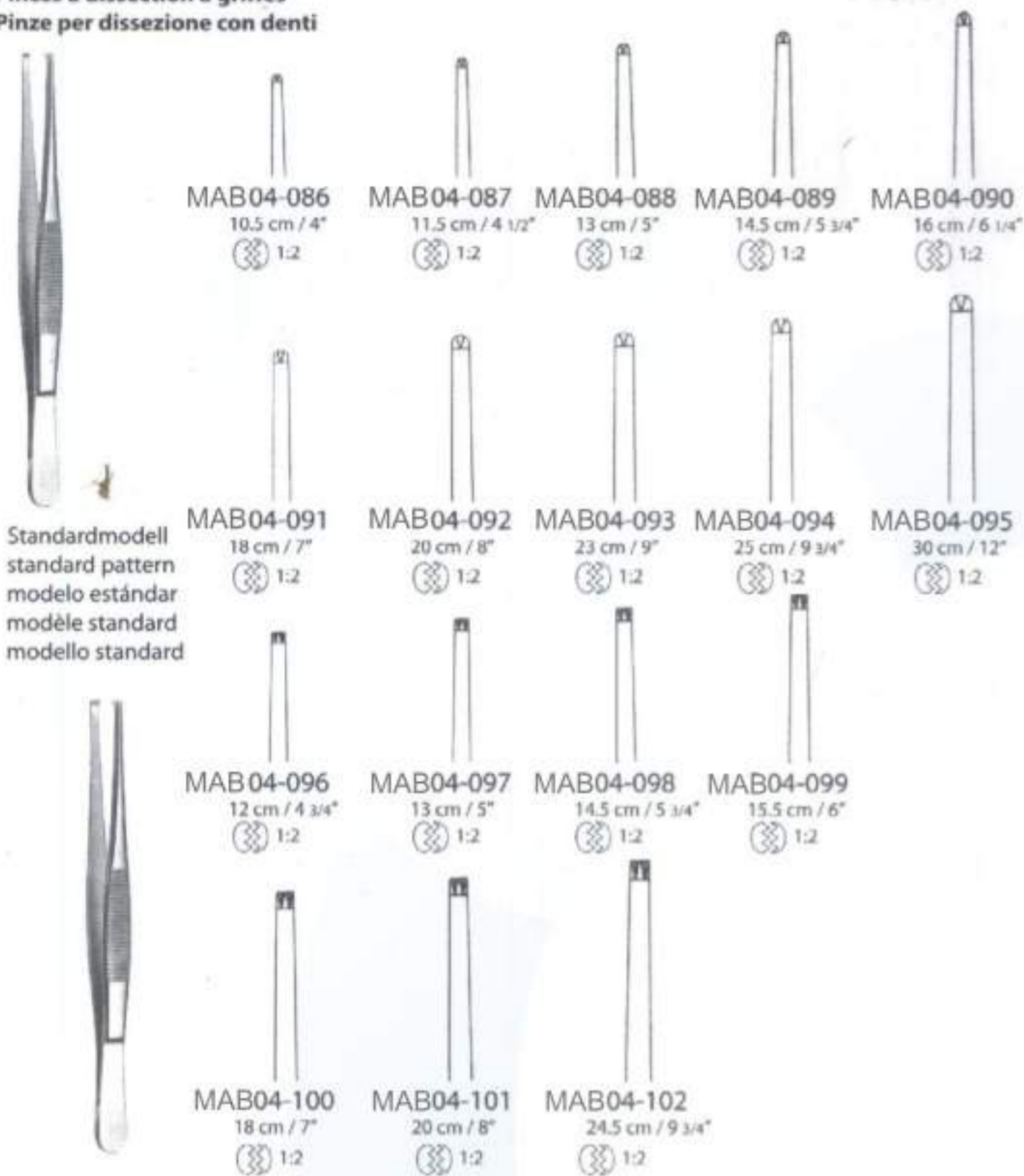

Allgemeines Instrumentarium . Instrumentation générale . Instrumentario general

Chirurgische Pinzetten  
Dissecting Forceps  
Pinzas de disección con dientes  
Pinces à dissection à griffes  
Pinze per dissezione con denti

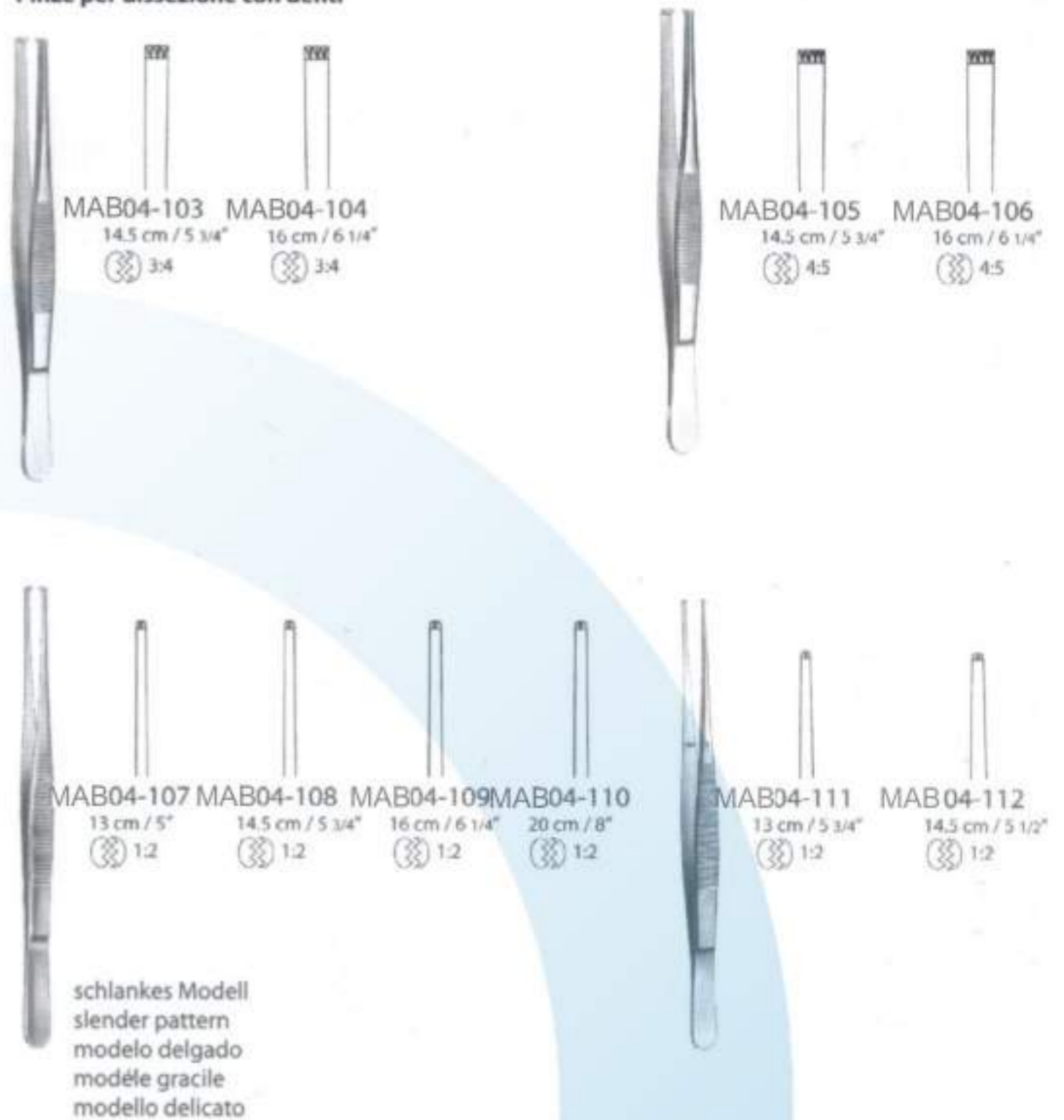

Allgemeines Instrumentarium . General Instrumentation . Instrumental general

Chirurgische Pinzetten  
Dissecting Forceps  
Pinzas de disección con dientes  
Pinces à dissection à griffes  
Pinze per dissezione con denti



Allgemeines Instrumentarium . Instrumentation générale . Instrumentario generale

Chirurgische Pinzetten  
Dissecting Forceps  
Pinzas de disección con dientes  
Pinces à dissection à griffes  
Pinze per dissezione con denti

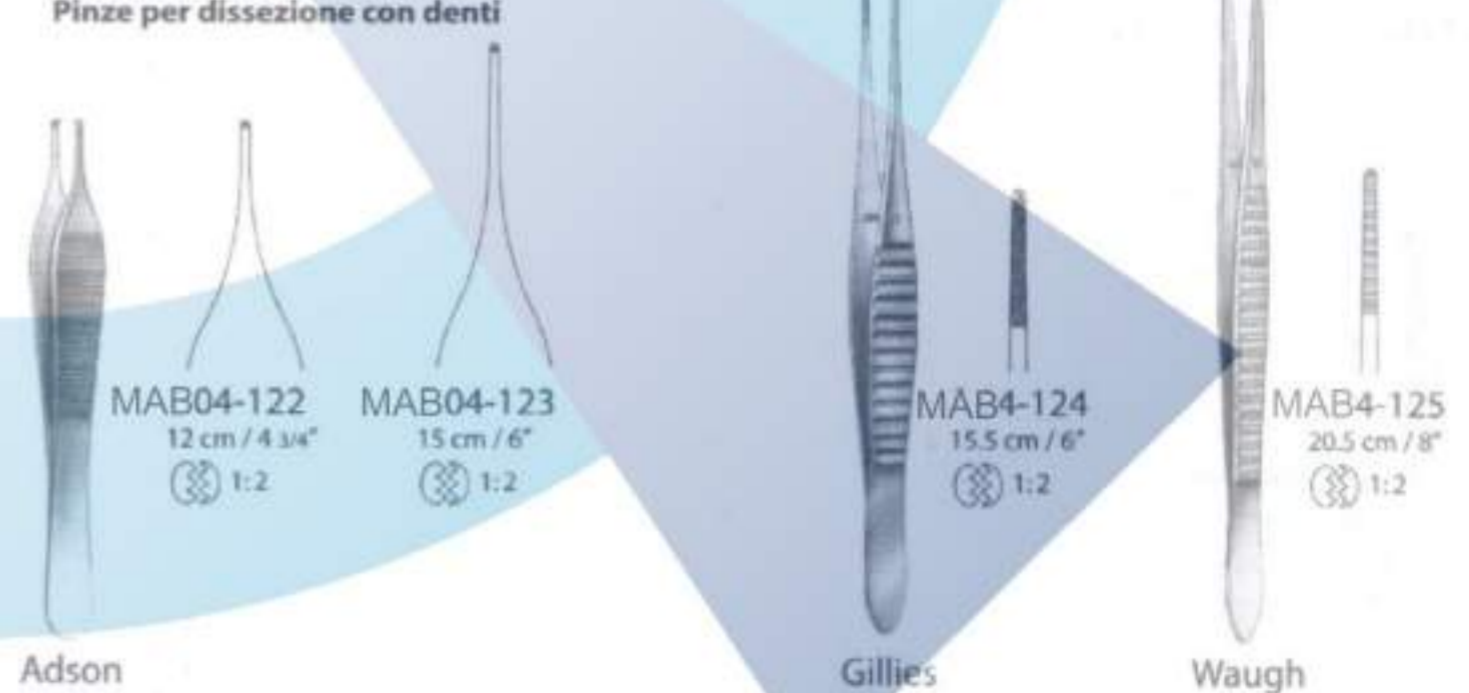



Allgemeines Instrumentarium . General Instrumentation . Instrumental general  
 Chirurgische Mikropinzetten, Chirurgische Pinzetten  
 Micro Dissecting Forceps, Dissecting Forceps  
 Micro Pinzas de disección con dientes, Pinzas de disección con dientes  
 Micro-Pinces à dissection à griffes, Pinces à dissection à griffes  
 Micro-Pinze per dissezione con denti, Pinze per dissezione con denti

Allgemeines Instrumentarium . Instrumentation générale . Strumentario generale  
 Chirurgische Pinzetten  
 Dissecting Forceps  
 Pinzas de disección con dientes  
 Pinces à dissection à griffes  
 Pinze per dissezione con denti

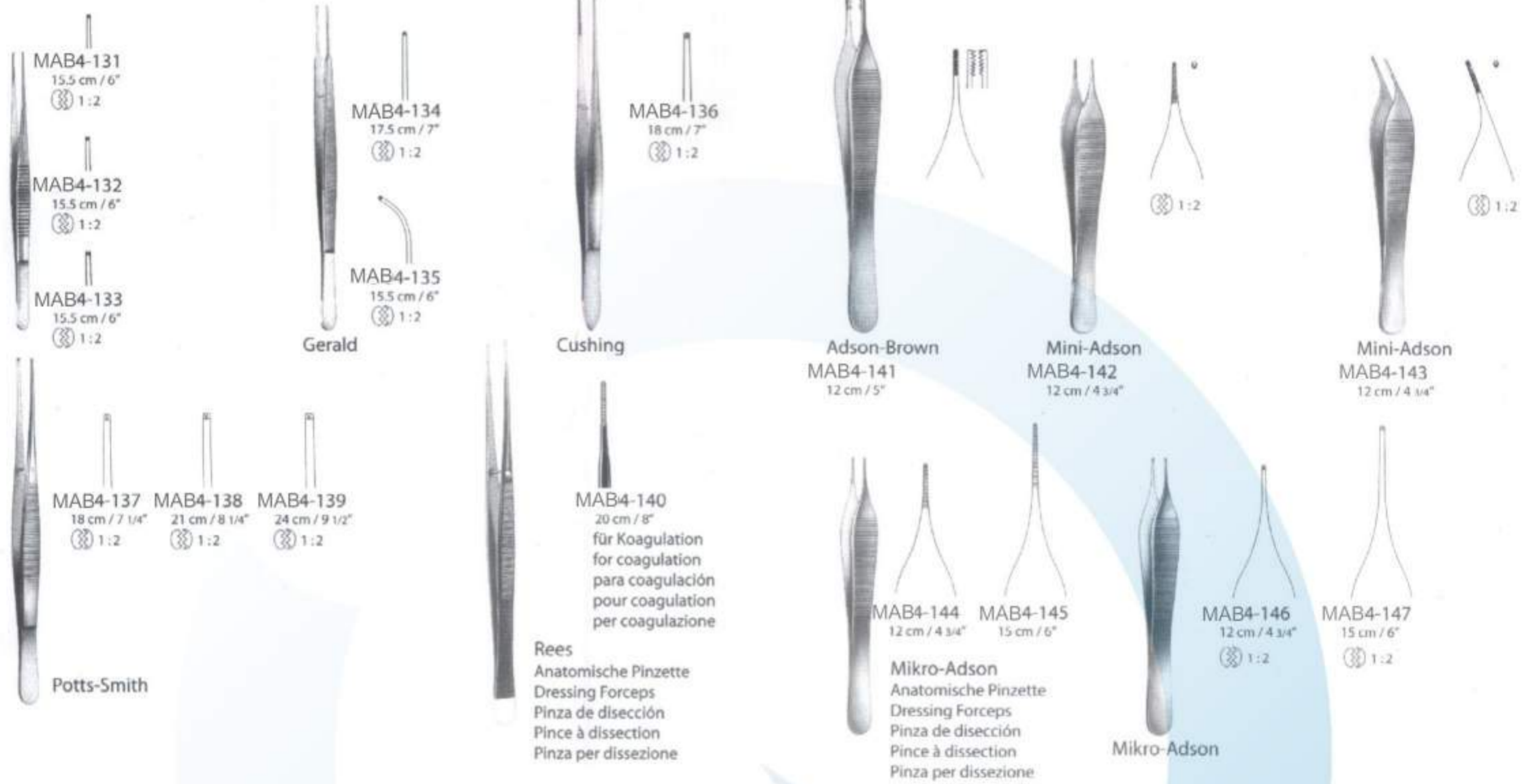

Allgemeines Instrumentarium . General Instrumentation . Instrumental general  
 Chirurgische Pinzetten, Uhrmacher-Pinzetten  
 Dissecting Forceps, Jeweller Type Forceps  
 Pinzas de disección con dientes, Pinzas de relojero  
 Pinces à dissection à griffes, Pinces d'horloger  
 Pinze per dissezione con denti, Pinze da orologiaio

Allgemeines Instrumentarium . Instrumentation générale . Strumentario generale  
 Chirurgische Pinzetten  
 Dissecting Forceps  
 Pinzas de disección con dientes  
 Pinces à dissection à griffes  
 Pinze per dissezione con denti

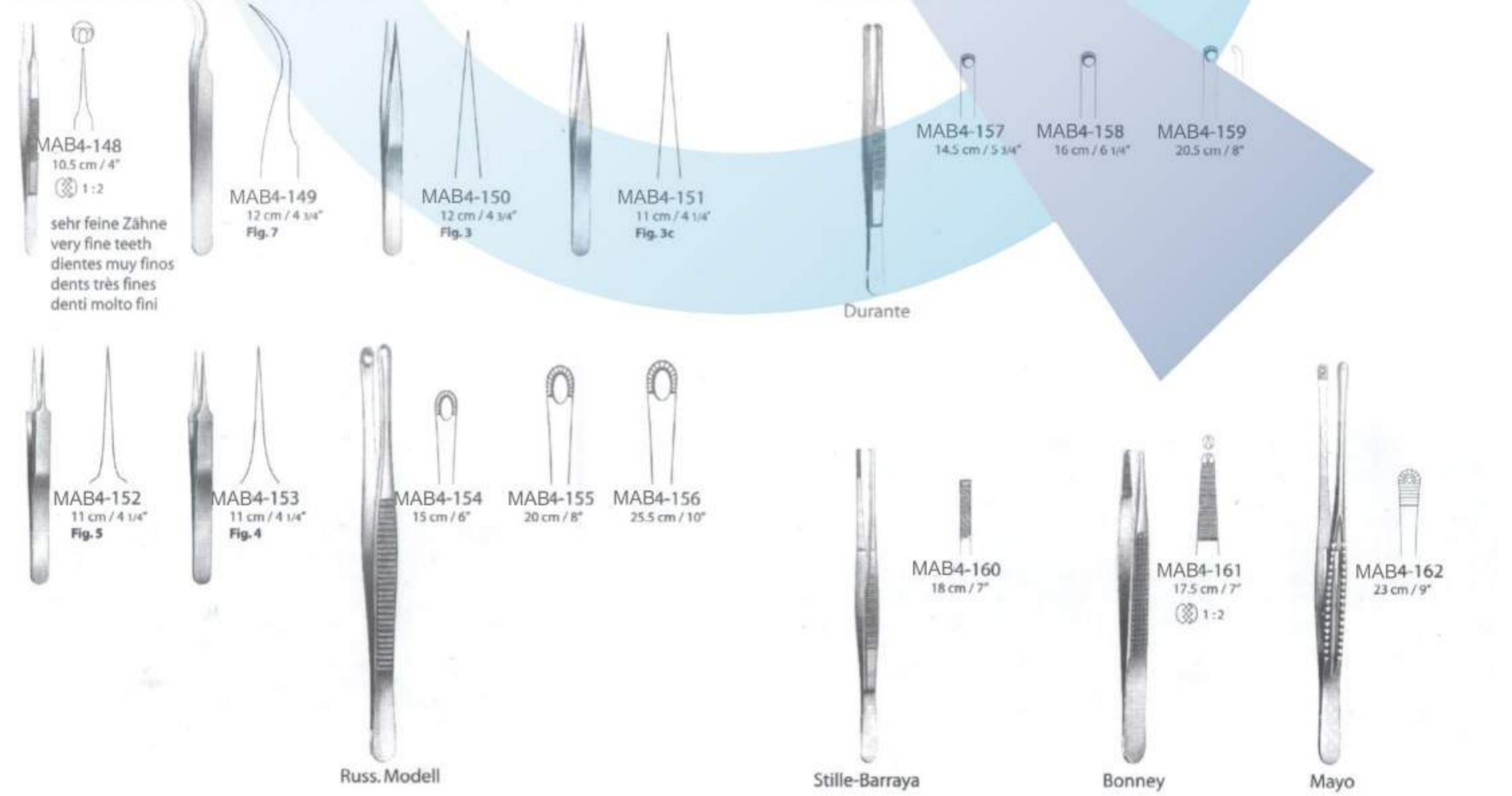



Allgemeines Instrumentarium . General Instrumentation . Instrumental general  
 Chirurgische Pinzetten  
 Dissecting Forceps  
 Pinzas de disección con dientes  
 Pincès à dissection à griffes  
 Pinze per dissezione con denti

Allgemeines Instrumentarium . Instrumentation générale . Strumentario generale  
 Anatomische Pinzetten  
 Dressing Forceps  
 Pinzas de disección  
 Pincès à dissection  
 Pinze per dissezione

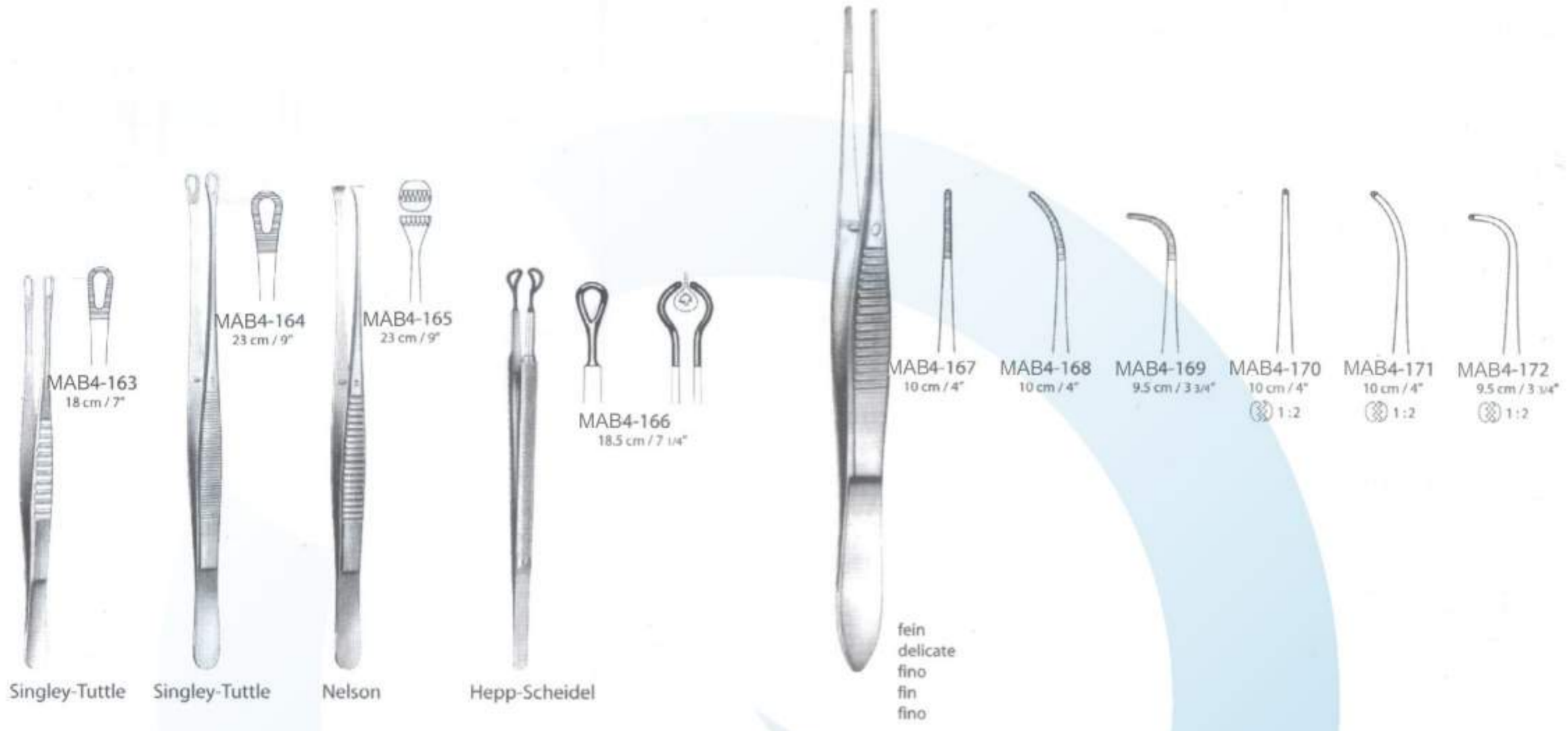

Allgemeines Instrumentarium . General Instrumentation . Instrumental general  
 Anatomische Mikropinzetten  
 Micro Dressing Forceps  
 Micro Pinzas de disección  
 Micro-Pincès à dissection  
 Micro-Pinze per dissezione

Allgemeines Instrumentarium . Instrumentation générale . Strumentario generale  
 Chirurgische Mikropinzetten  
 Micro Dissecting Forceps  
 Micro Pinzas de disección con dientes  
 Micro-Pincès à dissection à griffes  
 Micro-Pinze per dissezione con denti

Spitzen tips puntas pointes punte	6.0 x 0.4 mm	6.0 x 0.4 mm	6.0 x 0.7 mm	6.0 x 0.7 mm	6.0 x 0.8 mm	6.0 x 0.8 mm
stahl . steel . Acero . Acier . Acciaio	15 cm / 6" MAB4-173 MAB4-174 MAB4-175 MAB4-176					
Titan . Titanium . Titanio . Titane . Titanio	15 cm / 6" MAB4-177 MAB4-178 MAB4-179 MAB4-180					
stahl . steel . Acero . Acier . Acciaio	18 cm / 7" MAB4-181 MAB4-182 MAB4-183 MAB4-184					
Titan . Titanium . Titanio . Titane . Titanio	18 cm / 7" MAB4-185 MAB4-186 MAB4-187 MAB4-188					
stahl . steel . Acero . Acier . Acciaio	21 cm / 8 1/4" MAB4-189 MAB4-190					
Titan . Titanium . Titanio . Titane . Titanio	21 cm / 8 1/4" MAB4-191 MAB4-192					
stahl . steel . Acero . Acier . Acciaio	23 cm / 9" MAB4-193 MAB4-194					

**Titanium**

diamantiertes Maul  
 diamond coated jaw  
 boca diamantada  
 mors diamanté  
 morso diamantato

Spitzen tips puntas pointes punte	6.0 x 0.4 mm	6.0 x 0.4 mm	6.0 x 0.7 mm	6.0 x 0.7 mm	6.0 x 0.8 mm	6.0 x 0.8 mm
stahl . steel . Acero . Acier . Acciaio	15 cm / 6" MAB4-195 MAB4-196 MAB4-197 MAB4-198					
Titan . Titanium . Titanio . Titane . Titanio	15 cm / 6" MAB4-199 MAB4-200 MAB4-201 MAB4-202					
stahl . steel . Acero . Acier . Acciaio	18 cm / 7" MAB4-203 MAB4-204 MAB4-205 MAB4-206					
Titan . Titanium . Titanio . Titane . Titanio	18 cm / 7" MAB4-207 MAB4-208 MAB4-209 MAB4-210					
stahl . steel . Acero . Acier . Acciaio	21 cm / 8 1/4" MAB4-211 MAB4-212					
Titan . Titanium . Titanio . Titane . Titanio	21 cm / 8 1/4" MAB4-213 MAB4-214					
stahl . steel . Acero . Acier . Acciaio	23 cm / 9" MAB4-215 MAB4-216					

**Titanium**

diamantiertes Maul  
 diamond coated jaw  
 boca diamantada  
 mors diamanté  
 morso diamantato



Allgemeines Instrumentarium . General Instrumentation . Instrumental general

Mikro-Ringpinzetten, Atrauma-Mikropinzetten  
 Micro Ring Forceps, Atraumatic Micro Forceps  
 Micro Pinzas de disección con ojal, Micro Pinzas atraumáticas  
 Micro-Pinces à dissection à anneau, Micro-Pinces atraumatiques à dissection  
 Micro-Pinze per dissezione con anello, Micro-Pinze Atraumatiche





Spitzen tips puntas pointes punte	1.0 x 0.5 mm	2.0 x 1.0 mm	1.2 mm
stahl . steel . Acero . Acier . Acciaio	15 cm / 6"	MAB 04-217	MAB 04-218
			MAB04-219
Titan . Titanium . Titanio . Titane . Titanio	15 cm / 6"	MAB 04-220	MAB 04-221
			MAB04-222
stahl . steel . Acero . Acier . Acciaio	18 cm / 7"	MAB04-223	MAB04-224
			MAB04-225
Titan . Titanium . Titanio . Titane . Titanio	18 cm / 7"	MAB04-226	MAB04-227
			MAB04-228
stahl . steel . Acero . Acier . Acciaio	21 cm / 8 1/4"	MAB04-229	MAB04-230
			MAB04-231
Titan . Titanium . Titanio . Titane . Titanio	21 cm / 8 1/4"	MAB04-232	MAB04-233
			MAB04-234
stahl . steel . Acero . Acier . Acciaio	23 cm / 9"	MAB04-235	MAB04-236

**Titanium**

diamantiertes Maul  
 diamond coated jaw  
 boca diamantada  
 mors diamanté  
 morso diamantato





Allgemeines Instrumentarium . Instrumentation générale . Strumentario generale

Splinterpinzetten  
 Splinter Forceps  
 Pinzas para espinas  
 Pinces à échardes  
 Pinze per scheggie

 MAB04-237 12.5 cm / 5" glattes Maul Smooth jaw boca lisa mors lisse morso liscio	 MAB04-238 12.5 cm / 5" glattes Maul Smooth jaw boca lisa mors lisse morso liscio	 MAB04-239 12.5 cm / 5" gerieftes Maul serrated jaw boca estriada mors estries morso striato	 MAB05-240 12.5 cm / 5" gerieftes Maul serrated jaw boca estriada mors estries morso striato
 MAB04-241 15.5 cm / 6" Mikro-Knüpfpinzette Micro Tying Forceps Micro Pinza para anudar Micro-Pince à poser des ligatures Micro-Pinza per lagature	 MAB04-242 7.5 cm / 3 1/4" Feilchenfeld	 MAB04-243 9 cm / 3 1/2"	 MAB04-244 11.5 cm / 4 1/2"







Allgemeines Instrumentarium . General Instrumentation . Instrumental general

Splinterpinzetten  
 Splinter Forceps  
 Pinzas para espinas  
 Pinces à échardes  
 Pinze per scheggie

 Hunter	 MAB04-245 10.5 cm / 4"	 MAB04-246 10.5 cm / 4"	 MAB04-247 10 cm / 4" Mikroskopierpinzette superleicht, stumpf Microscopic Forceps super light, blunt Pinza para microscopia super ligero, roma Pince à microscopie très légère, mousse Pinza per microscopia molto leggera, smussa	 MAB04-248 10 cm / 4" Mikroskopierpinzette superleicht, spitz Microscopic Forceps super light, pointed Pinza para microscopia super ligero, puntiaguda Pince à microscopie très légère, mousse Pinza per microscopia molto leggera, appuntata
--	--	--	--	--

Allgemeines Instrumentarium . Instrumentation générale . Strumentario generale

Splinterpinzetten, Cilienpinzetten  
 Splinter Forceps, Cilia Forceps  
 Pinzas para espinas, Pinzas depilatorias  
 Pinces à échardes, Pinces à épiler les cils  
 Pinze per scheggie, Pinze depilatoria

 MAB04-249 9.5 cm / 3 3/4" Shaaf	 MAB04-250 8.5 cm / 3 1/4" Littauer glattes Maul smooth jaw boca lisa Mors lisse morso liscio	 MAB04-251 8.5 cm / 3 1/4" Douglas	 MAB04-252 9 cm / 3 1/2"
 MAB04-253 9 cm / 3 1/2" Douglas	 MAB04-254 9 cm / 3 1/2" Beer glattes Maul smooth jaw boca lisa Mors lisse morso liscio	 MAB04-255 10.5 cm / 4" Barraquer glattes Maul smooth jaw boca lisa Mors lisse morso liscio	



Allgemeines Instrumentarium . General Instrumentation . Instrumental general  
 Splitterzangen  
 Splinter Forceps  
 Pinzas para espinas  
 Pincers à échardes  
 Pinze per scheggie



Stieglitz

MAB04-256  
14 cm / 5 1/2"

MAB04-257  
13.5 cm / 5 1/4"



Peet

MAB04-258  
12.5 cm / 5"



Ralk

MAB04-259  
15 cm / 6"

MAB04-260  
15 cm / 6"

## MAB 05

Arterinklemmen  
 Haemostatic Forceps  
 Pinzas hemostaticas  
 Pincers hemostatiques  
 Pinze emostatiche



Allgemeines Instrumentarium . General Instrumentation . Instrumental general  
 Clip-Anlegepinzette, Gefäßclips  
 Clip Applying Forceps, Vesel Clips  
 Pinzas para aplicar clips, Clips vasculares  
 Pincers pour poser les clips vasculaires, Clips vasculaires  
 Pinze per applicazione approssimatori, Clip vascolari



MAB05-001  
14.5 cm / 5 3/4"  
ohne Schloss  
without lock  
sin cierre  
sans serrure  
senza serratura



MAB05-002  
14.5 cm / 5 3/4"  
mit Schloss  
with lock  
con cierre  
avec serrure  
con serratura



Biemer

	MAB05-003	MAB05-004	MAB05-005
Maulöffnung jaw opening apertura de la boca ouverture de mors apertura di morso	4 mm	4 mm	4 mm
Maulöffäng jaw length longitud de la boca longueur de mors lunghezza del morso	6 mm	6 mm	6 mm
Schließdruck closing pressure presión de cierre pression d'occlusion pressione di chiusura	30-40 gr.	30-40 gr.	30-40 gr.

Allgemeines Instrumentarium . General Instrumentation . Instrumentation general  
 Bulldogklemmen  
 Bulldog Clamps  
 Clamps Bulldog  
 Clamps Bulldog  
 Pinze Bulldog



extra leicht  
extra light  
extra ligero  
extrêmement léger  
molto leggere

	MAB05-006	MAB05-007	MAB05-008	MAB05-009	MAB05-010	MAB05-011
Länge length longitud longueur lunghezza	31 mm	35 mm	39 mm	30 mm	33 mm	36 mm
Maullänge jaw length longitud de la boca longueur de mors lunghezza del morso	10 mm	10 mm	10 mm	10 mm	10 mm	10 mm
Schließdruck closing pressure presión de cierre pression d'occlusion pressione di chiusura	30 gr.	30 gr.	30 gr.	30 gr.	30 gr.	30 gr.
Gewicht weight peso poids peso	1 gr.	1 gr.	1 gr.	1 gr.	1 gr.	1 gr.



Allgemeines Instrumentarium . Instrumentation générale . Strumentario generale

Bulldogklemmen  
Bulldog Clamps  
Clamps Bulldog  
Clamps Bulldog  
Pinze Bulldog

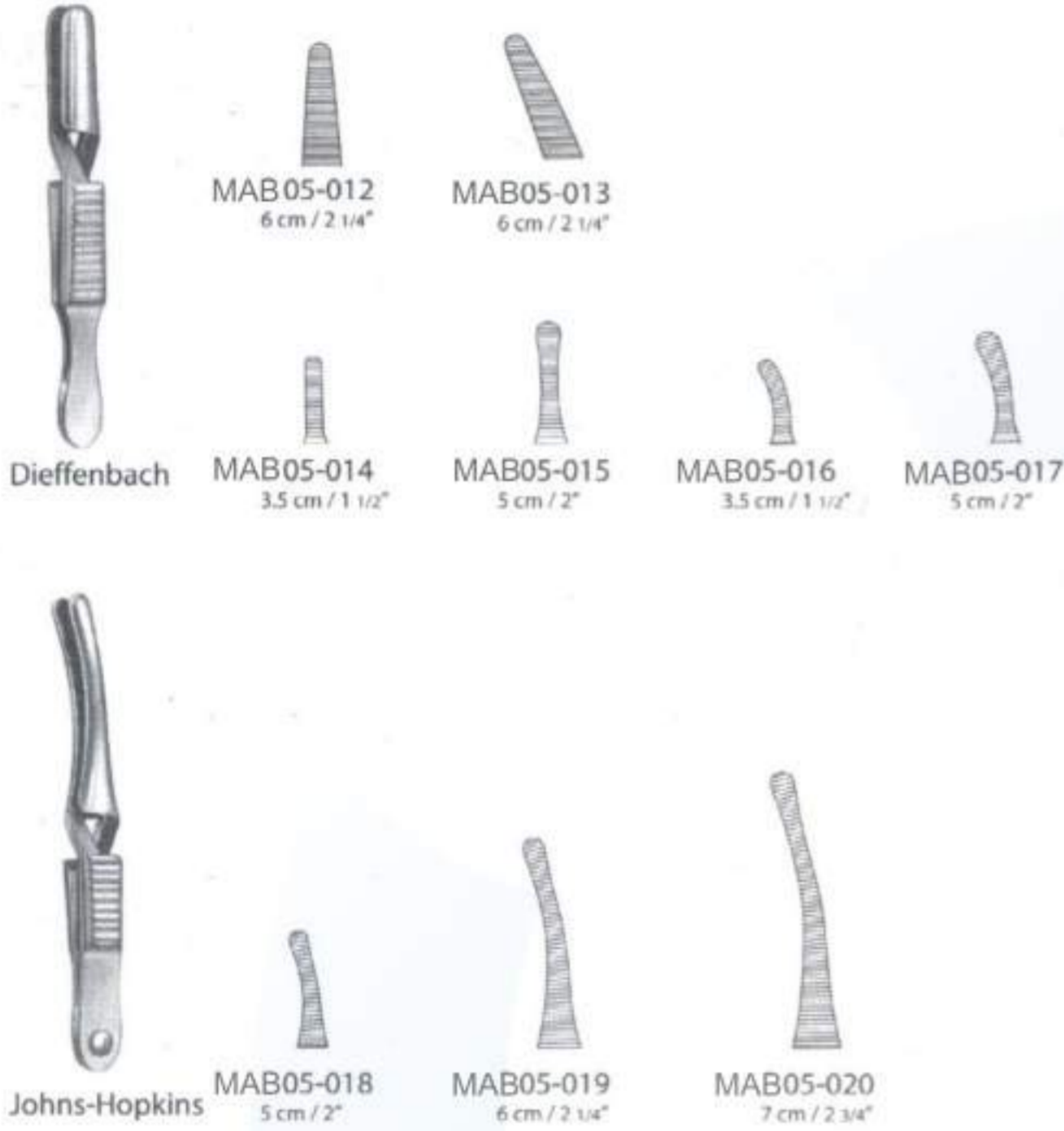

Allgemeines Instrumentarium . General Instrumentation . Instrumental general

Bulldogklemmen  
Bulldog Clamps  
Clamps Bulldog  
Clamps Bulldog  
Pinze Bulldog



	MAB05-021	MAB05-022	MAB05-023	MAB05-024	MAB05-025	MAB05-026
Länge length longitud longueur lunghezza	4,5 cm	4,55 cm	5 cm	4,5 cm	5 cm	6 cm
Maullänge jaw length longitud de la boca longueur des mors lunghezza del morso	8 mm	12 mm	20 mm	8 mm	12 mm	20 mm
Schließdruck closing pressure presión de cierre pression d'occlusion pressione di chiusura	50 gr.	50 gr.	50 gr.	50 gr.	50 gr.	50 gr.
Gewicht weight peso poids peso	3 gr.	3 gr.	3 gr.	3 gr.	3 gr.	3 gr.

Allgemeines Instrumentarium . General Instrumentation . Instrumental general

Bulldogklemmen  
Bulldog Clamps  
Clamps Bulldog  
Clamps Bulldog  
Pinze Bulldog



	MAB05-027	MAB05-028	MAB05-029	MAB05-030	MAB05-031	MAB05-032
Länge length longitud longueur lunghezza	4,5 cm	5 cm	6 cm	3,5 cm	4,5 cm	6 cm
Maullänge jaw length longitud de la boca longueur des mors lunghezza del morso	10 mm	14 mm	20 mm	10 mm	14 mm	20 mm
Schließdruck closing pressure presión de cierre pression d'occlusion pressione di chiusura	180 gr.	180 gr.	180 gr.	180 gr.	180 gr.	180 gr.
Gewicht weight peso poids peso	3 gr.	3 gr.	3 gr.	3 gr.	3 gr.	3 gr.

Allgemeines Instrumentarium . Instrumentation générale . Instrumentario general

Bulldogklemmen  
Bulldog Clamps  
Clamps Bulldog  
Clamps Bulldog  
Pinze Bulldog



	MAB05-033	MAB05-034	MAB05-035	MAB05-036
	Vena	Vena	Vena	Vena
Schließdruck closing pressure presión de cierre pression d'occlusion pressione di chiusura	110 +/- 10 gr.	110 +/- 10 gr.	110 +/- 10 gr.	110 +/- 10 gr.

	MAB05-037	MAB05-038	MAB05-039	MAB05-040
	Arteria	Arteria	Arteria	Arteria
Schließdruck closing pressure presión de cierre pression d'occlusion pressione di chiusura	220 +/- 10 gr.	220 +/- 10 gr.	220 +/- 10 gr.	220 +/- 10 gr.

	MAB05-037	MAB05-038	MAB05-039	MAB05-040
Länge length longitud longueur lunghezza	30 mm	35 mm	40 mm	50 mm
Maullänge jaw length longitud de la boca longueur des mors lunghezza del morso	9 mm	13 mm	14 mm	23 mm
Gewicht weight peso poids peso	1 gr.	1 gr.	1 gr.	1,5 gr.



**Allgemeines Instrumentarium . General Instrumentation . Instrumental general**  
**Bulldogklemmen**  
**Bulldog Clamps**  
**Clamps Bulldog**  
**Clamps Bulldog**  
**Pinze Bulldog**



MAB05-041	MAB05-042	MAB05-043	MAB05-044
Vena	Vena	Vena	Vena
Schließdruck closing pressure presión de cierre pression d'occlusion pressione di chiusura	110 +/- 10 gr.	110 +/- 10 gr.	110 +/- 10 gr.



MAB05-045	MAB05-046	MAB05-047	MAB05-048
Arteria	Arteria	Arteria	Arteria
Schließdruck closing pressure presión de cierre pression d'occlusion pressione di chiusura	220 +/- 10 gr.	220 +/- 10 gr.	220 +/- 10 gr.

	30 mm	35 mm	40 mm	50 mm
Mauillänge jaw length longitud de la boca longueur des mors lunghezza del morso	9 mm	13 mm	14 mm	22 mm
Gewicht weight peso poids peso	1 gr.	1 gr.	1 gr.	1.5 gr.

**Allgemeines Instrumentarium . General Instrumentation . Instrumental general**  
**Bulldogklemmen**  
**Bulldog Clamps**  
**Clamps Bulldog**  
**Clamps Bulldog**  
**Pinze Bulldog**



	MAB05-049	MAB05-050	MAB05-051	MAB05-052
Vena	Vena	Vena	Vena	Vena
Schließdruck closing pressure presión de cierre pression d'occlusion pressione di chiusura	110 +/- 10 gr.	110 +/- 10 gr.	110 +/- 10 gr.	110 +/- 10 gr.



	MAB05-053	MAB05-054	MAB05-055	MAB05-056
Arteria	Arteria	Arteria	Arteria	Arteria
Schließdruck closing pressure presión de cierre pression d'occlusion pressione di chiusura	220 +/- 10 gr.	220 +/- 10 gr.	220 +/- 10 gr.	220 +/- 10 gr.

	30 mm	35 mm	40 mm	50 mm
Mauillänge jaw length longitud de la boca longueur des mors lunghezza del morso	10 mm	14 mm	15 mm	21 mm
Gewicht weight peso poids peso	1 gr.	1 gr.	1 gr.	1.5 gr.

**Allgemeines Instrumentarium . Instrumentation générale . Strumentario generale**  
**Arterienklemmen**  
**Haemostatic Forceps**  
**Pinzas hemostáticas**  
**Pinces hémostatiques**  
**Pinze emostatiche**



Pean



MAB05-057 14.5 cm / 5 3/4"  
MAB05-058 16 cm / 6 1/4"

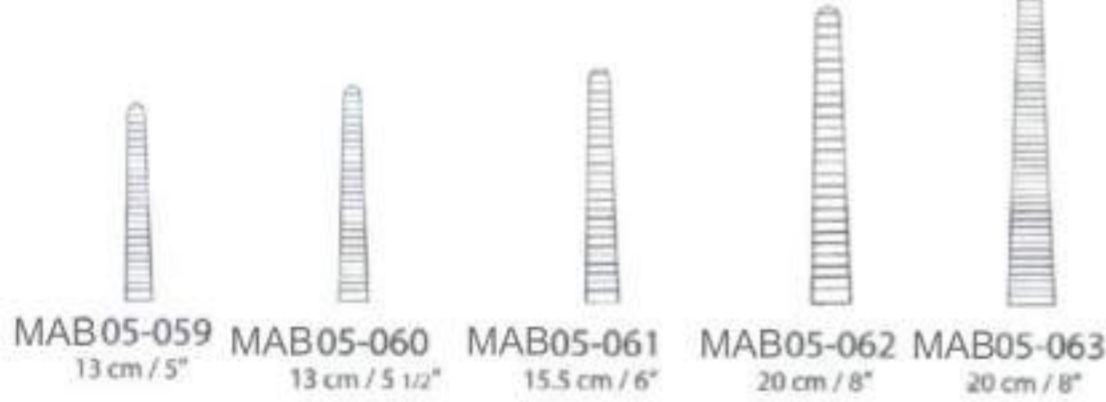

MAB05-059 13 cm / 5"  
MAB05-060 13 cm / 5 1/2"  
MAB05-061 15.5 cm / 6"  
MAB05-062 20 cm / 8"  
MAB05-063 20 cm / 8"

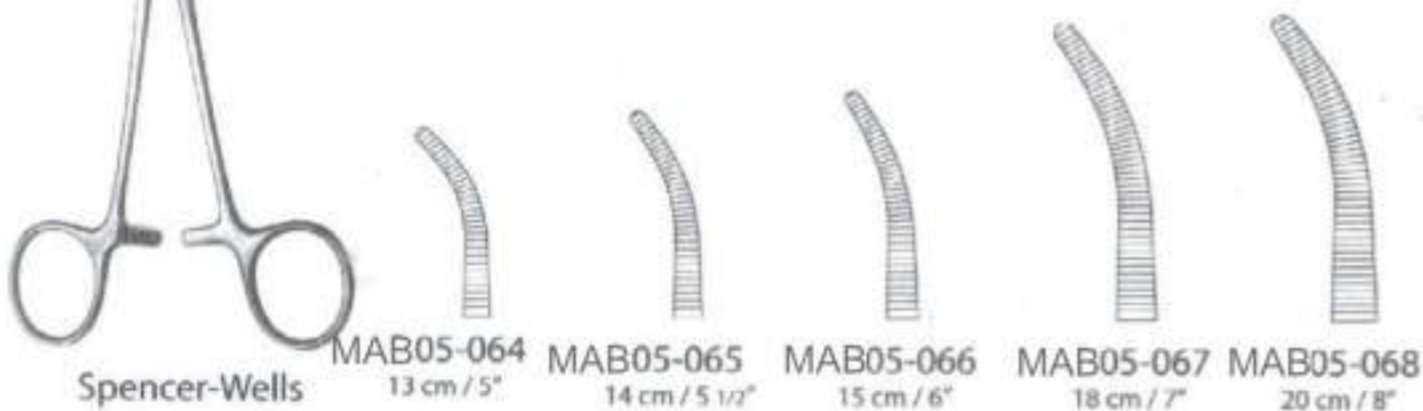

Spencer-Wells 13 cm / 5"  
MAB05-064 13 cm / 5"  
MAB05-065 14 cm / 5 1/2"  
MAB05-066 15 cm / 6"  
MAB05-067 18 cm / 7"  
MAB05-068 20 cm / 8"

**Allgemeines Instrumentarium . General Instrumentation . Instrumental general**  
**Arterienklemmen, Organfasszangen**  
**Haemostatic, Forceps, Organ Grasping Forceps**  
**Pinzas hemostáticas, Pinzas para sacar órganos**  
**Pinces hémostatiques, Pinces pour saisir des organes**  
**Pinze emostatiche, Pinze per a afferrare organi**

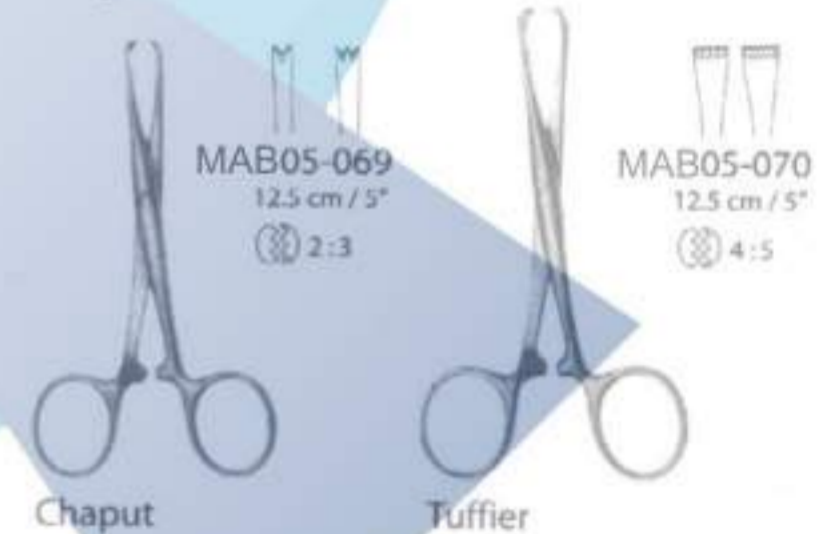

MAB05-069 12.5 cm / 5"  
⊗ 2:3  
Chaput

MAB05-070 12.5 cm / 5"  
⊗ 4:5  
Tuffier



Atrauma



MAB05-071 25 cm / 9 3/4"  
MAB05-072 26 cm / 10 1/4"



Allgemeines Instrumentarium . Instrumentation générale . Strumentario generale

Organfasszangen, Arterienklemmen  
 Organ Grasping Forceps, Haemostatic Forceps  
 Pinzas para sacar órganos, Pinzas hemostáticas  
 Pincers pour saisir des organes, Pincers hémostatiques  
 Pinze per afferrare organi, Pinze emostatiche



Allgemeines Instrumentarium . General Instrumentation . Instrumental general

Präparierklemmen, Arterienklemmen  
 Dissecting and Ligature Forceps, Haemostatic Forceps  
 Pinzas para preparación y ligadura, Pinzas hemostáticas  
 Pincers à disséquer et à ligatures, Pincers hémostatiques  
 Pinze per preparazioni e legature, Pinze emostatiche

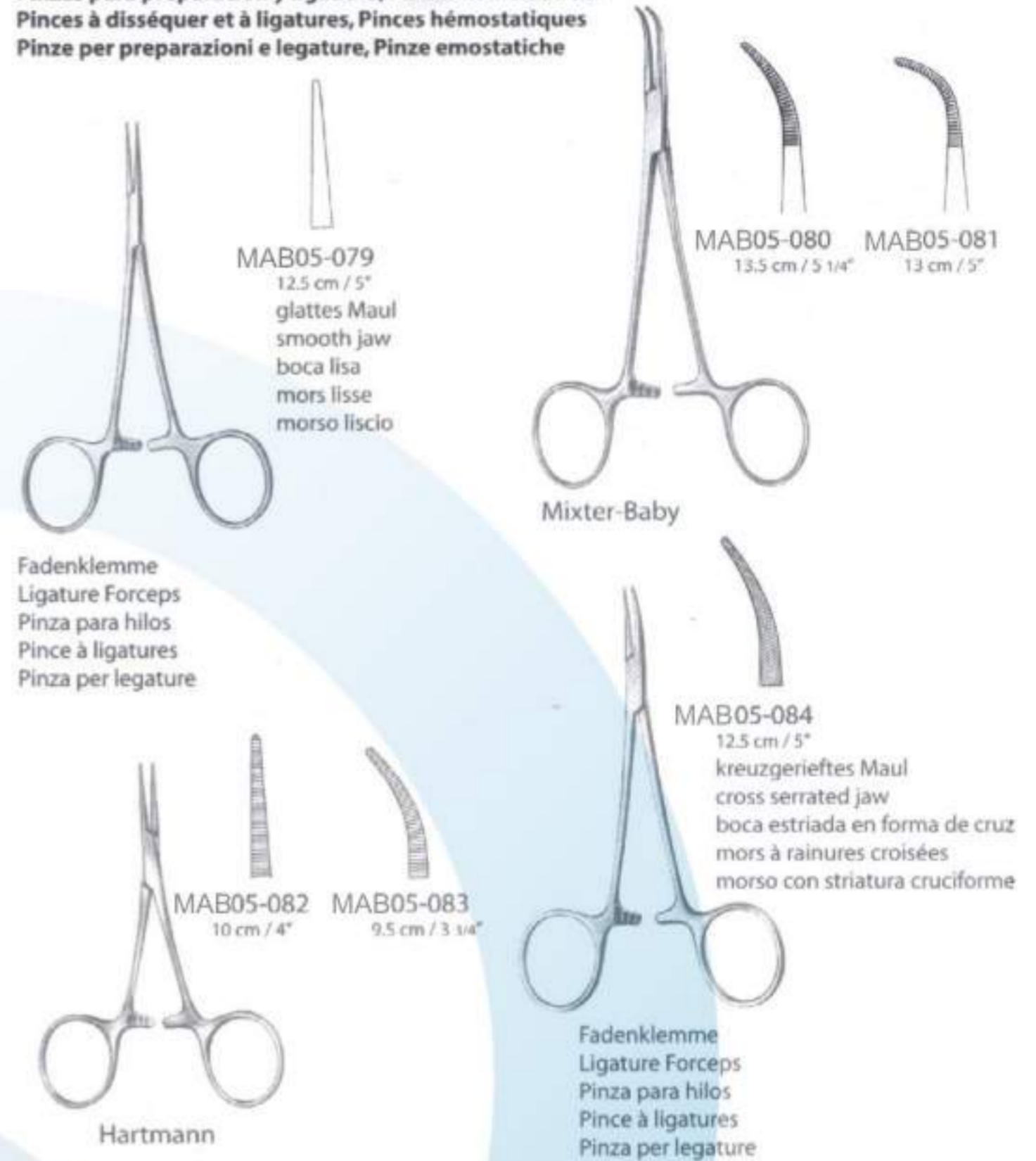

Allgemeines Instrumentarium . Instrumentation générale . Strumentario generale

Arterienklemmen  
 Haemostatic Forceps  
 Pinzas hemostáticas  
 Pincers hémostatiques  
 Pinze emostatiche

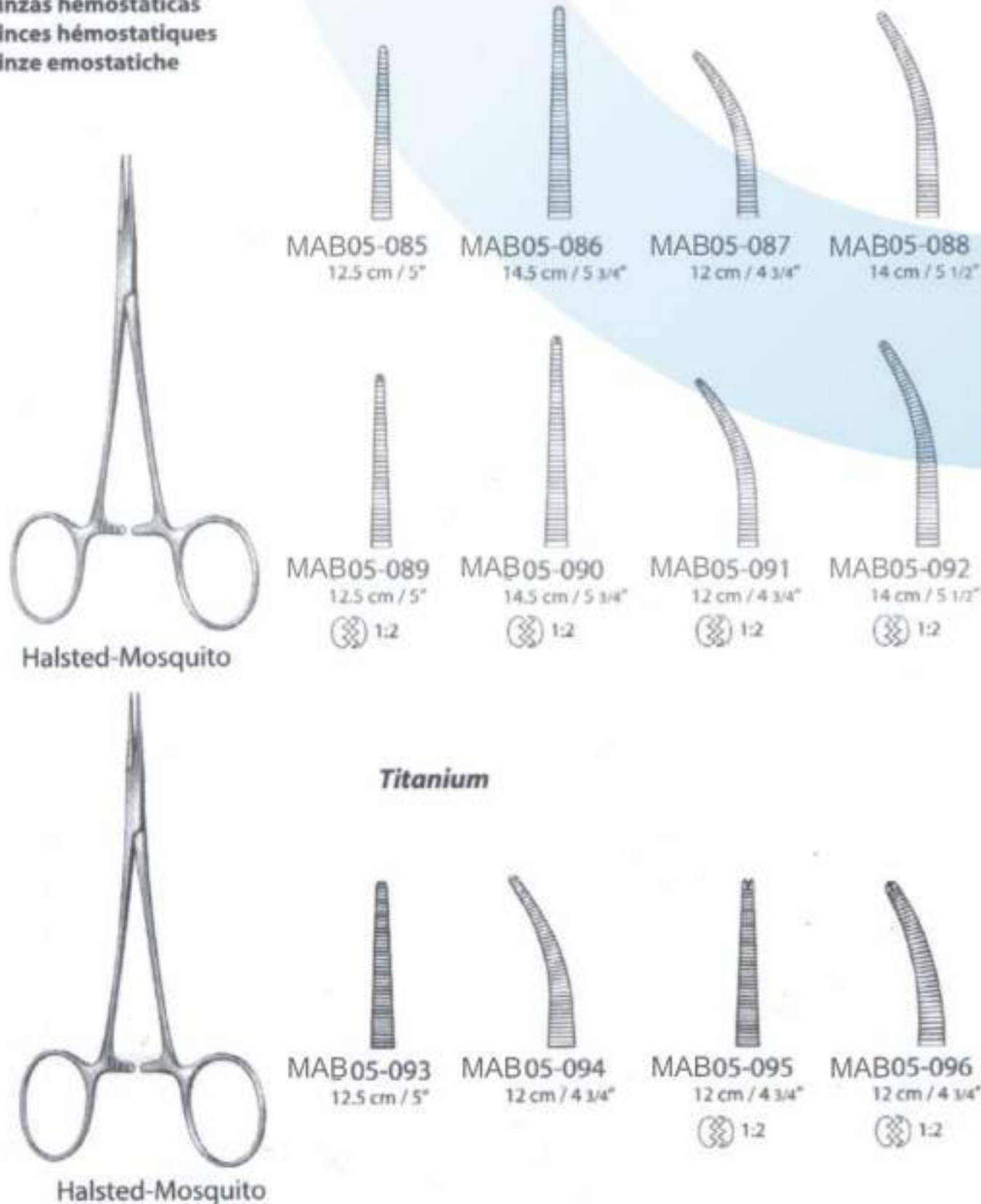

Allgemeines Instrumentarium . General Instrumentation . Instrumental general

Arterienklemmen  
 Haemostatic Forceps  
 Pinzas hemostáticas  
 Pincers hémostatiques  
 Pinze emostatiche

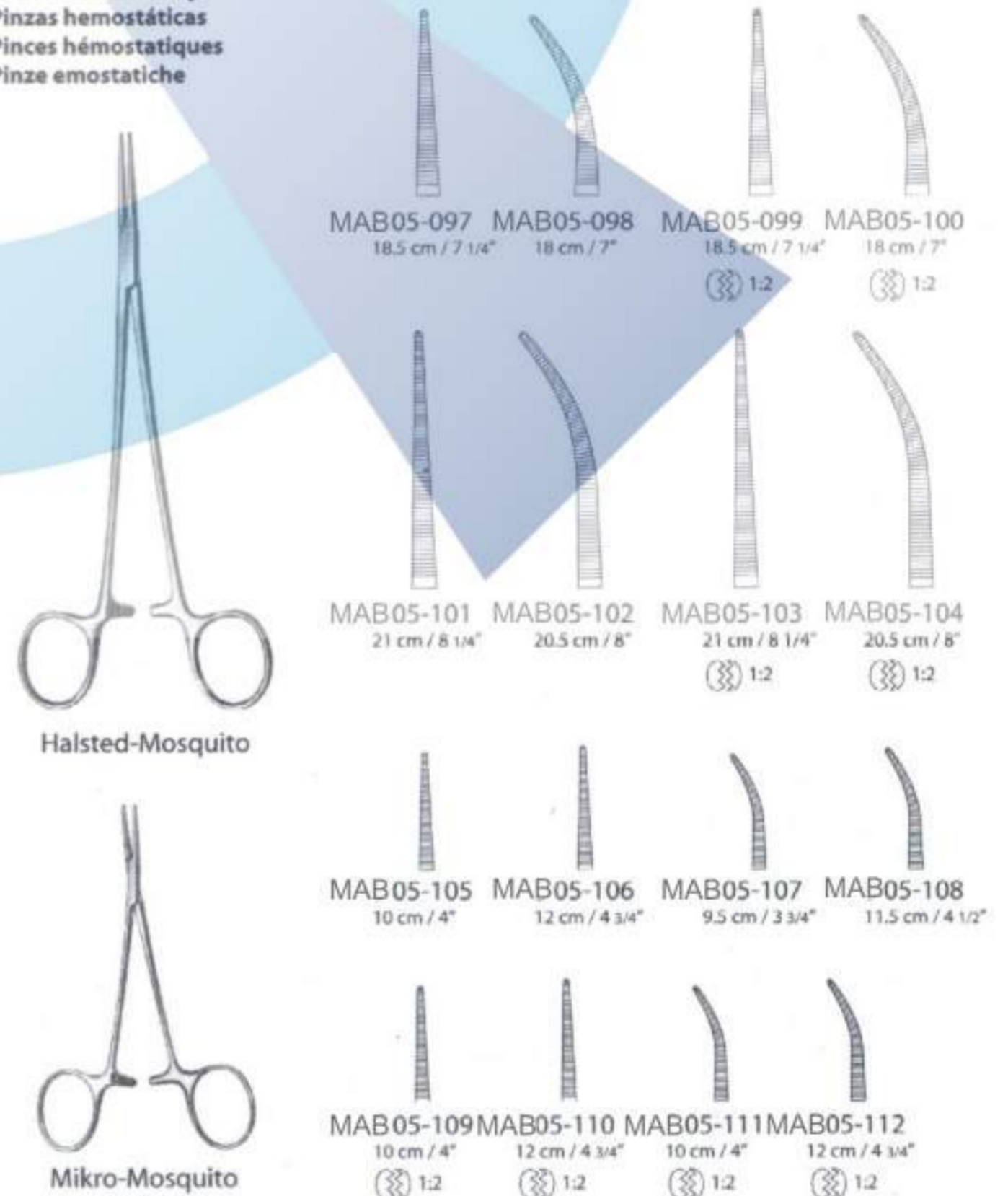



Allgemeines Instrumentarium . Instrumentation générale . Strumentario generale

Arterienklemmen  
Haemostatic Forceps  
Pinzas hemostáticas  
Pincas hémostatiques  
Pinze emostatiche



MAB05-113  
14 cm / 5 1/2"

Providence-Hospital



MAB05-114  
14 cm / 5 1/2"



MAB05-115  
15.5 cm / 6"

Lerichie

MAB05-117  
15.5 cm / 6"



MAB05-116  
15 cm / 6"



MAB05-118  
15 cm / 6"



MAB05-119 MAB05-120  
14.5 cm / 5 3/4" 14 cm / 5 1/2"

Kelly

Allgemeines Instrumentarium . General Instrumentation . Instrumental general

Arterienklemmen  
Haemostatic Forceps  
Pinzas hemostáticas  
Pincas hémostatiques  
Pinze emostatiche

Titanium



MAB05-121  
14.5 cm / 5 3/4"

Kelly



MAB05-122  
14 cm / 5 1/2"

Titanium



MAB05-123  
14.5 cm / 5 3/4"

Crile



MAB05-124  
14 cm / 5 1/2"

Allgemeines Instrumentarium . Instrumentation générale . Strumentario generale

Arterienklemmen, Präparierklemmen  
Haemostatic Forceps, Dissecting and Ligature Forceps  
Pinzas hemostáticas, Pinzas para preparación y ligadura  
Pincas hémostatiques, Pincas à disséquer et à ligatures  
Pinze emostatiche, Pinze per preparazioni e legature



MAB05-125  
16 cm / 6 1/4"

Kelly-Rankin



MAB05-126  
15.5 cm / 6"



MAB05-127  
14 cm / 5 1/2"

Overholt-Baby



MAB05-132  
17 cm / 6 3/4"

Crile-Rankin



MAB05-133  
17 cm / 6 3/4"



MAB05-134  
17 cm / 6 3/4"

Lovelace



MAB05-135  
17 cm / 6 3/4"



MAB05-128  
14.5 cm / 5 3/4"

Crile



MAB05-129  
14 cm / 5 1/2"



MAB05-130  
20.5 cm / 8"



MAB05-131  
20.5 cm / 8"



MAB05-136  
12 cm / 4 3/4"  
seitlich gebogen  
laterally curved  
curva lateralmente  
courbe lateralement  
curva laterale

Dandy-Mosquito



MAB05-137  
14.5 cm / 5 3/4"  
seitlich gebogen  
laterally curved  
curva lateralmente  
courbe lateralement  
curva laterale

Dandy



MAB05-138  
14.5 cm / 5 3/4"  
seitlich gebogen  
laterally curved  
curva lateralmente  
courbe lateralement  
curva laterale





Allgemeines Instrumentarium . Instrumentation générale . Strumentario generale

Präparierklemmen, Arterienklemmen  
 Dissecting and Ligature Forceps, Haemostatic Forceps  
 Pinzas para preparación y ligadura, Pinzas hemostáticas  
 Pinces à disséquer et à ligatures, Pinces hémostatiques  
 Pinze per preparazioni e legature, Pinze emostatiche

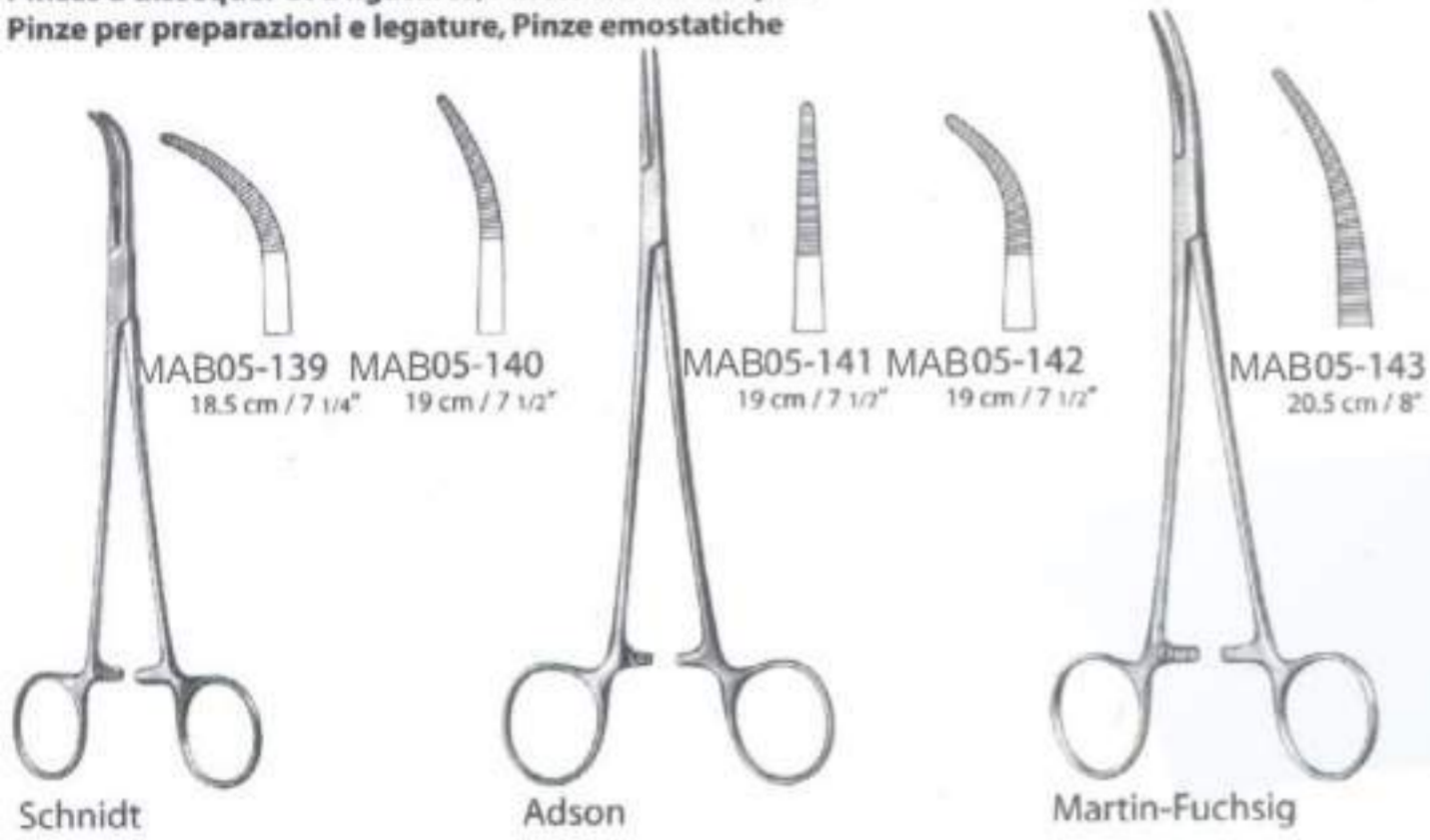

Allgemeines Instrumentarium . Instrumentation générale . Strumentario generale

Arterienklemmen  
 Haemostatic Forceps  
 Pinzas hemostáticas  
 Pinces hémostatiques  
 Pinze emostatiche

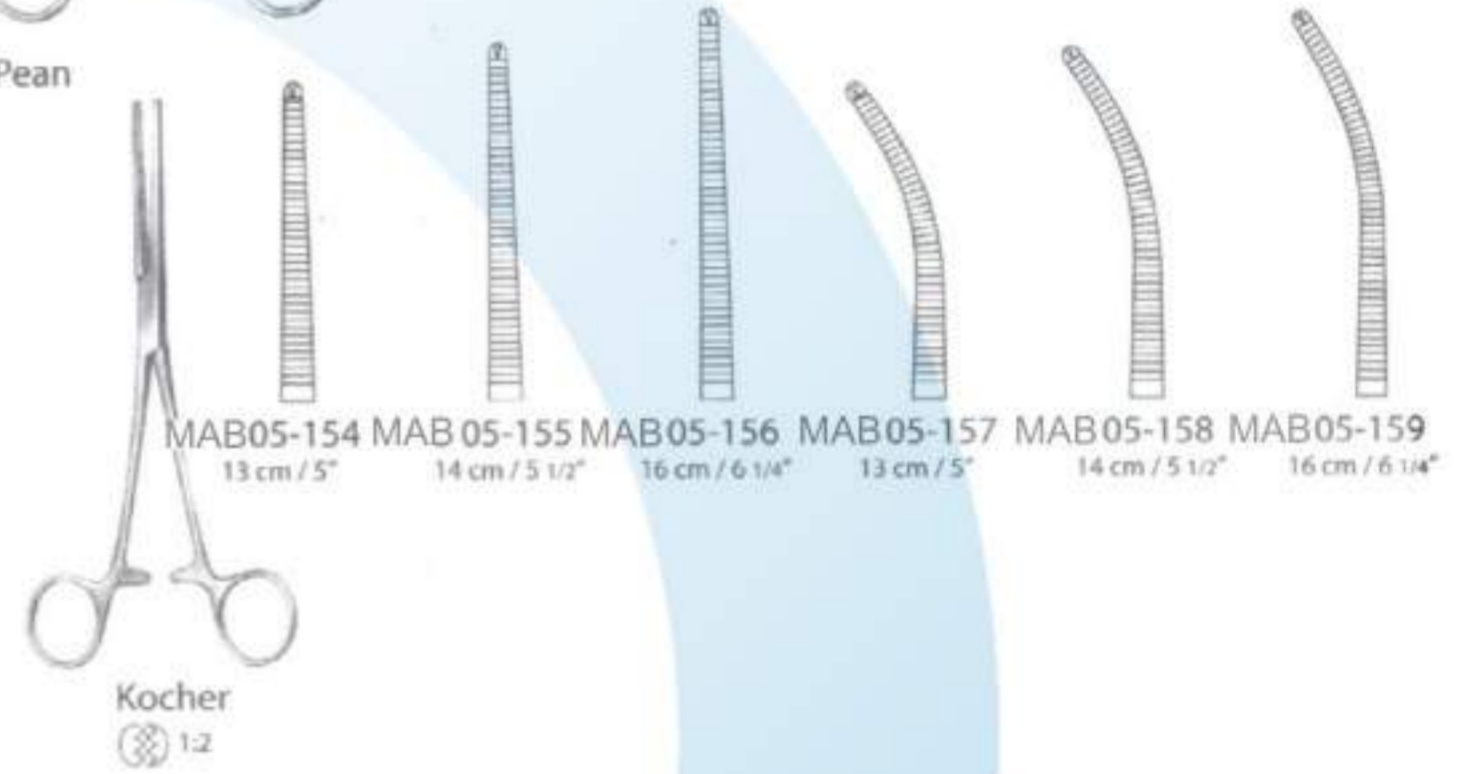
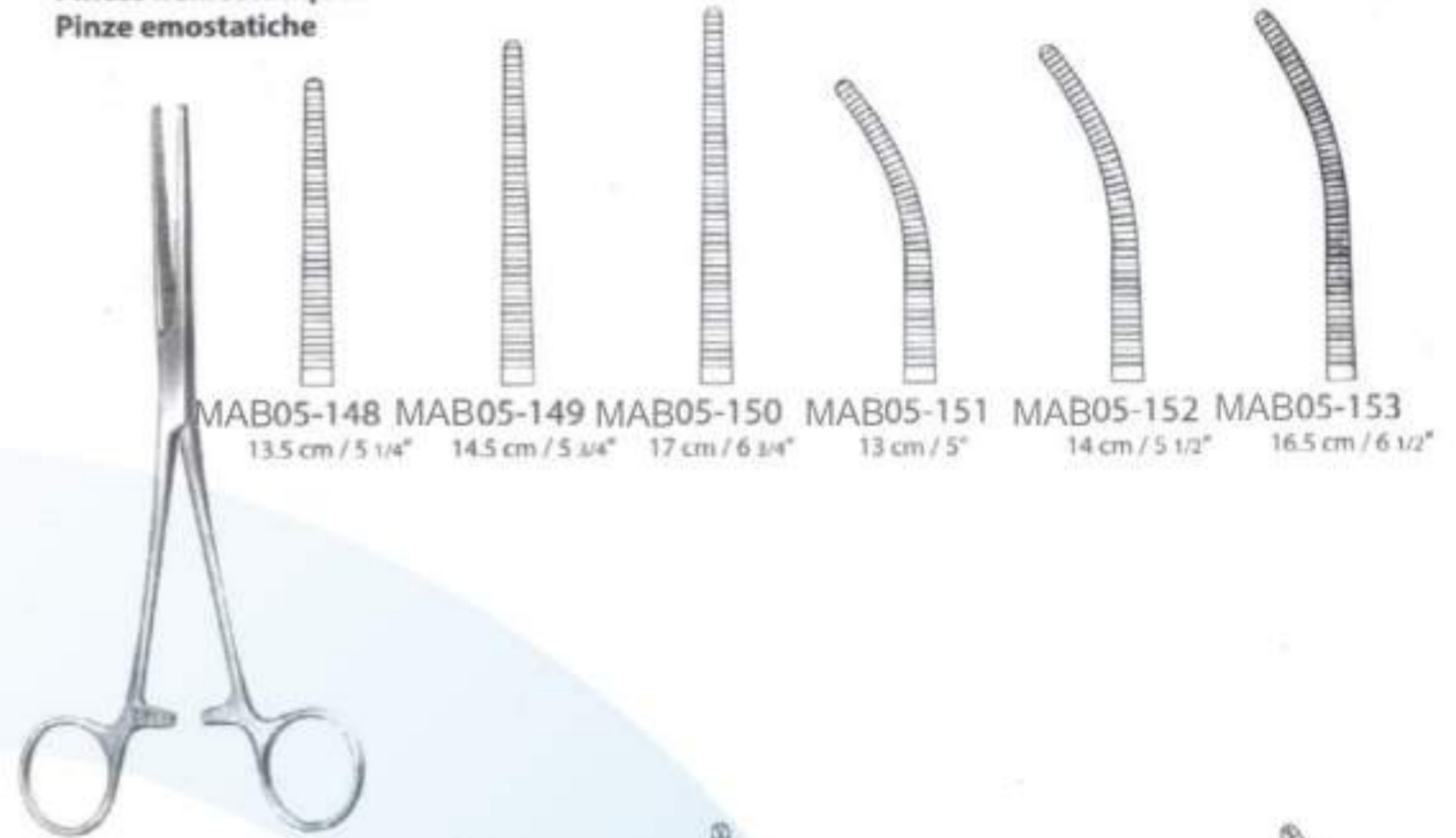

Allgemeines Instrumentarium . Instrumentation générale . Strumentario generale

Arterienklemmen  
 Haemostatic Forceps  
 Pinzas hemostáticas  
 Pinces hémostatiques  
 Pinze emostatiche

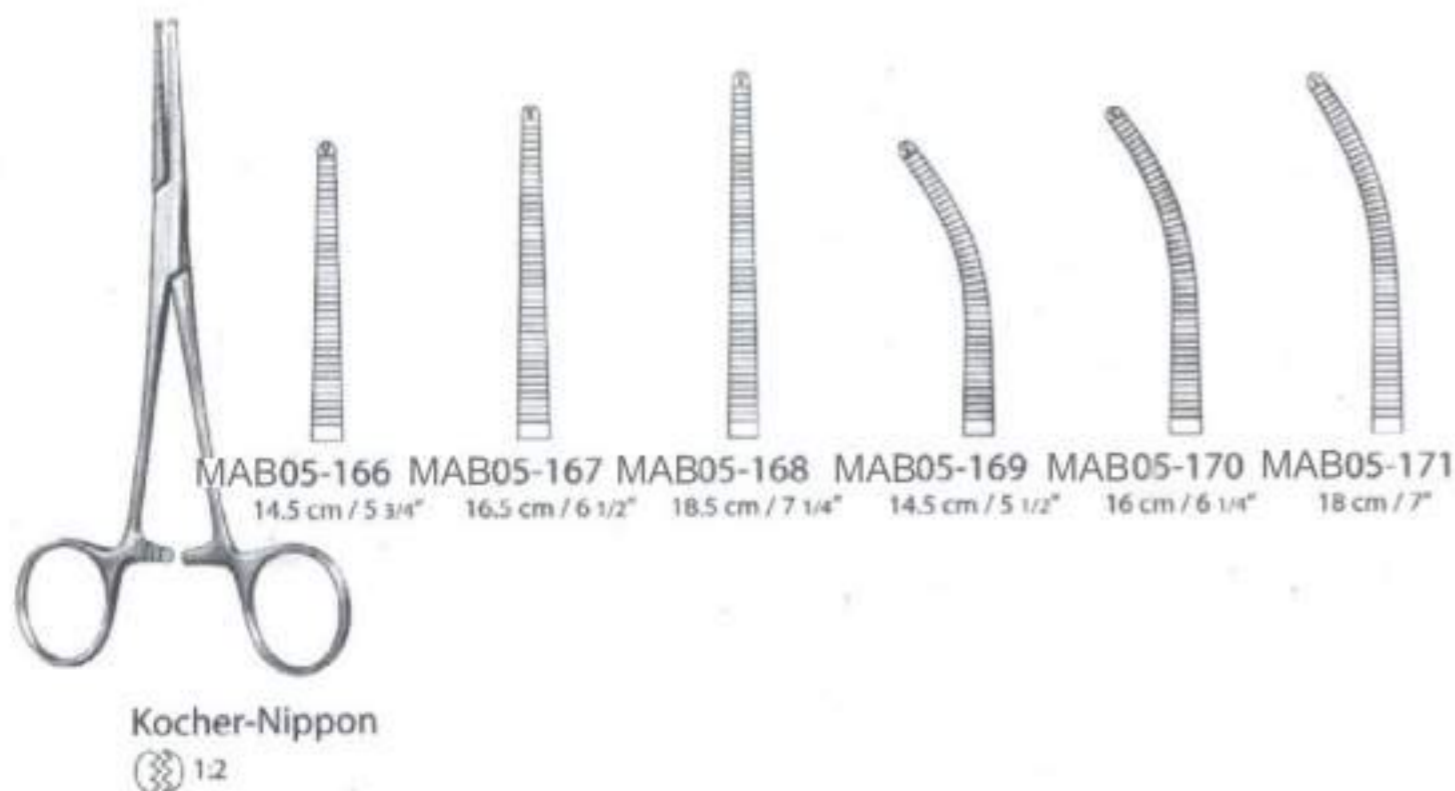
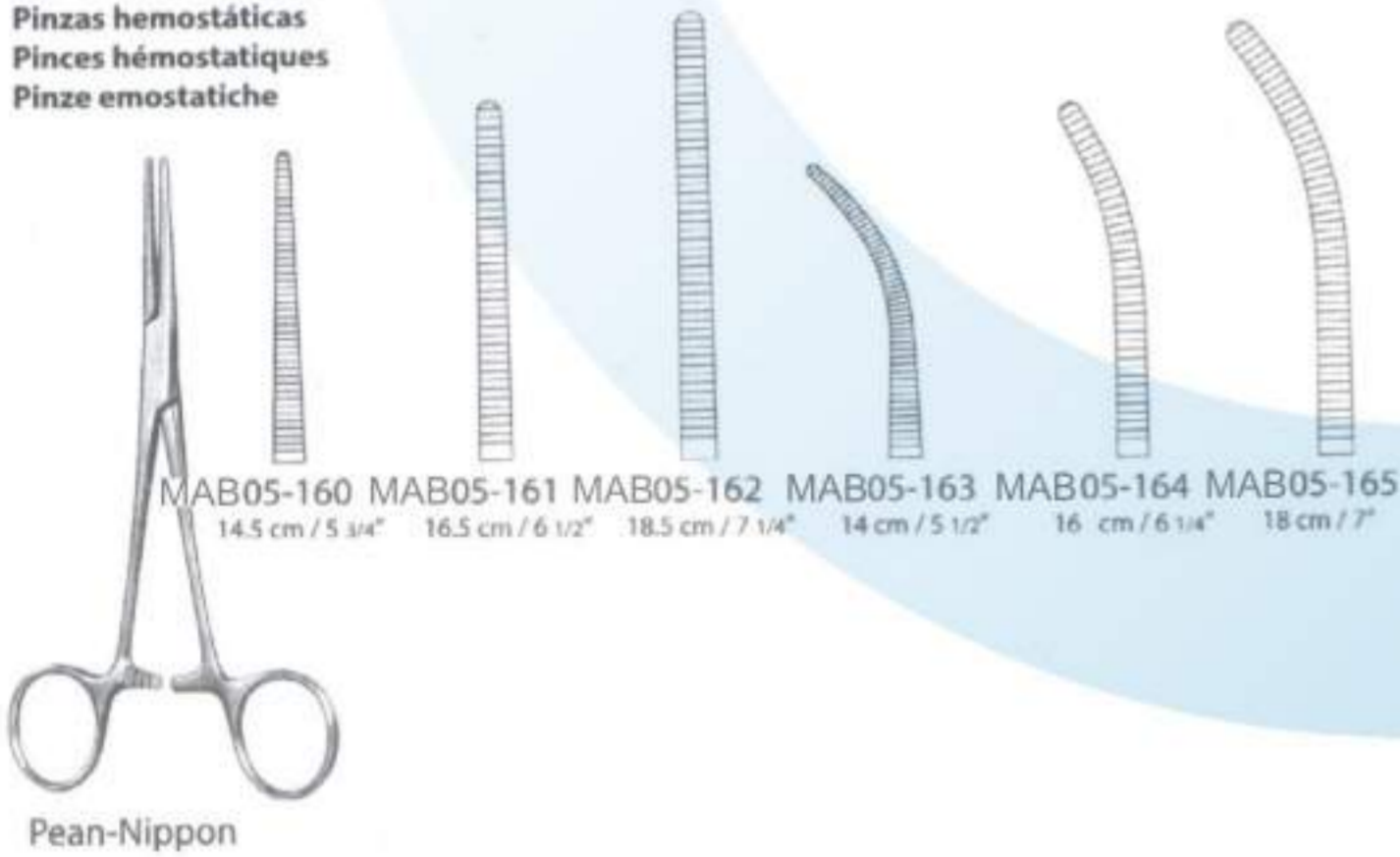

Allgemeines Instrumentarium . General Instrumentation . Instrumental general

Arterienklemmen  
 Haemostatic Forceps  
 Pinzas hemostáticas  
 Pinces hémostatiques  
 Pinze emostatiche

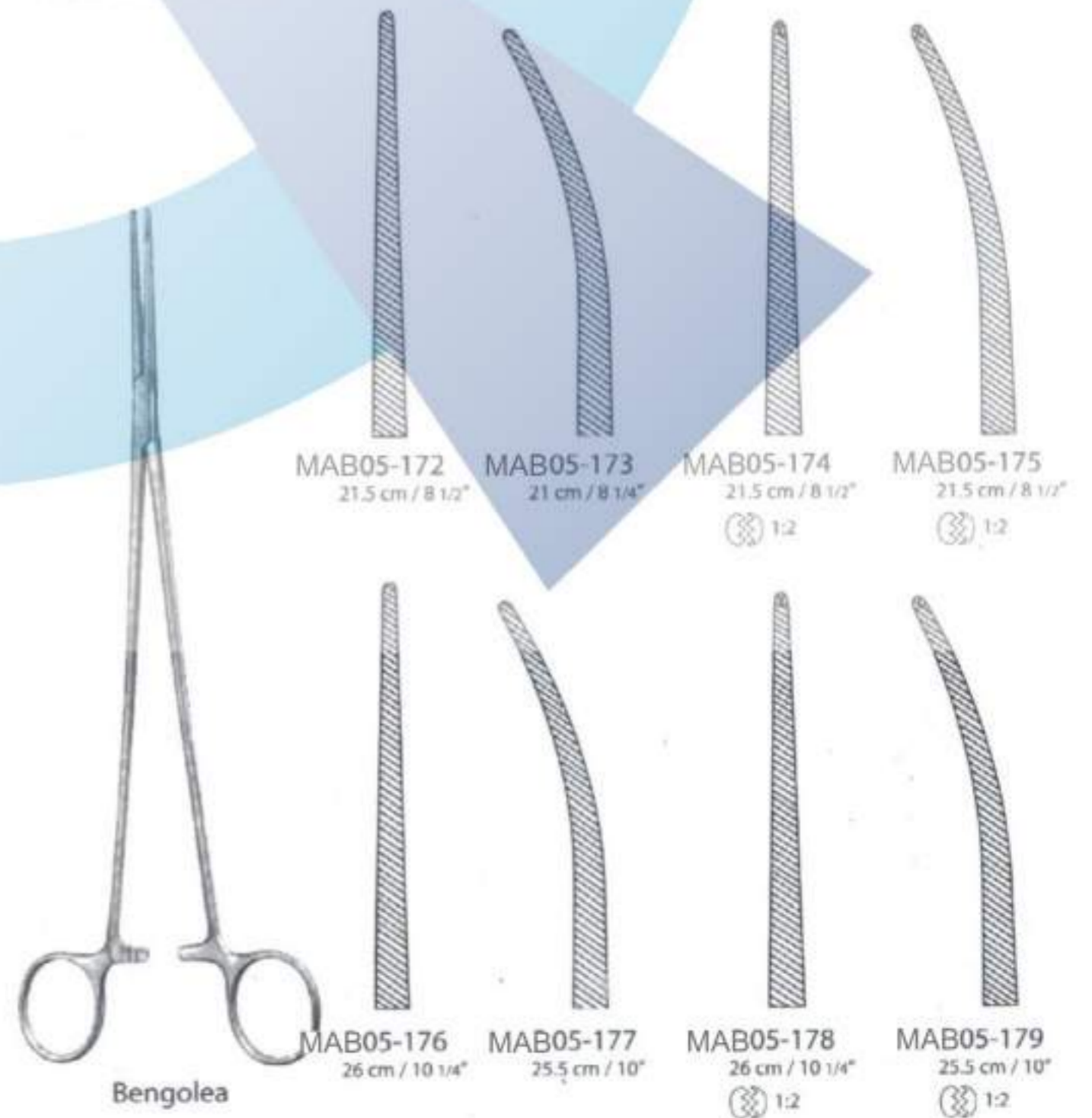



Allgemeines Instrumentarium . Instrumentation générale . Strumentario generale  
 Arterienklemmen  
 Haemostatic Forceps  
 Pinzas hemostáticas  
 Pinces hémostatiques  
 Pinze emostatiche

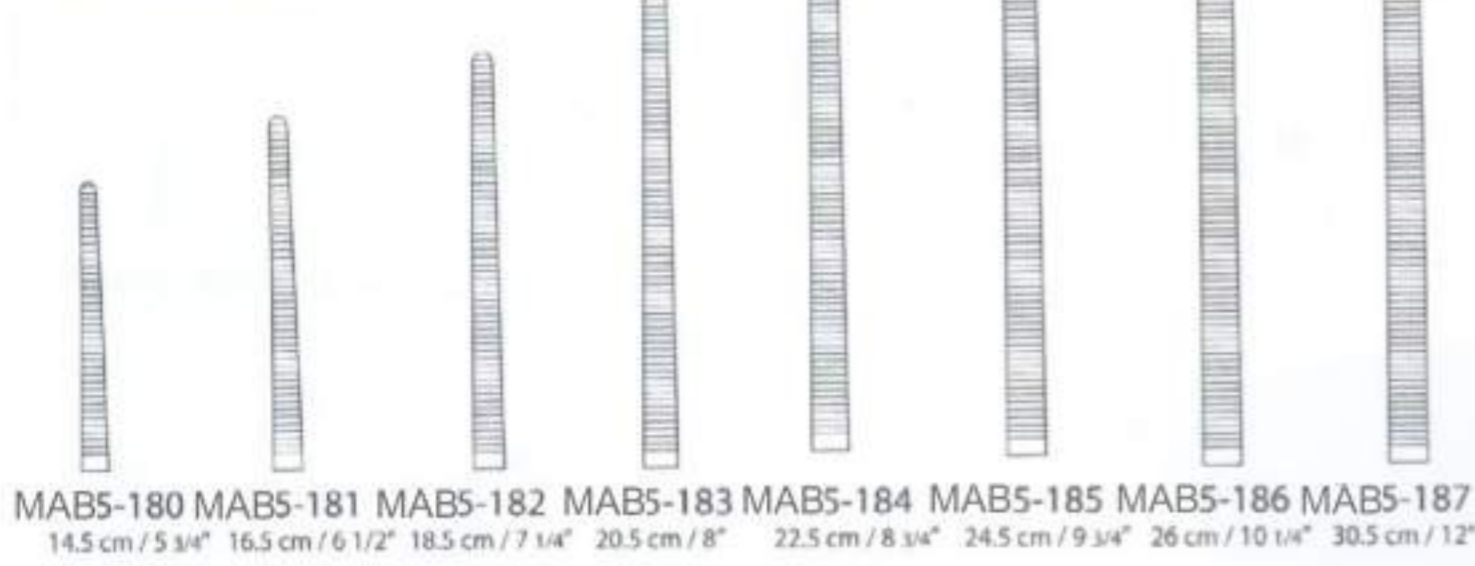

Allgemeines Instrumentarium . General Instrumentation . Instrumental general  
 Arterienklemmen  
 Haemostatic Forceps  
 Pinzas hemostáticas  
 Pinces hémostatiques  
 Pinze emostatiche

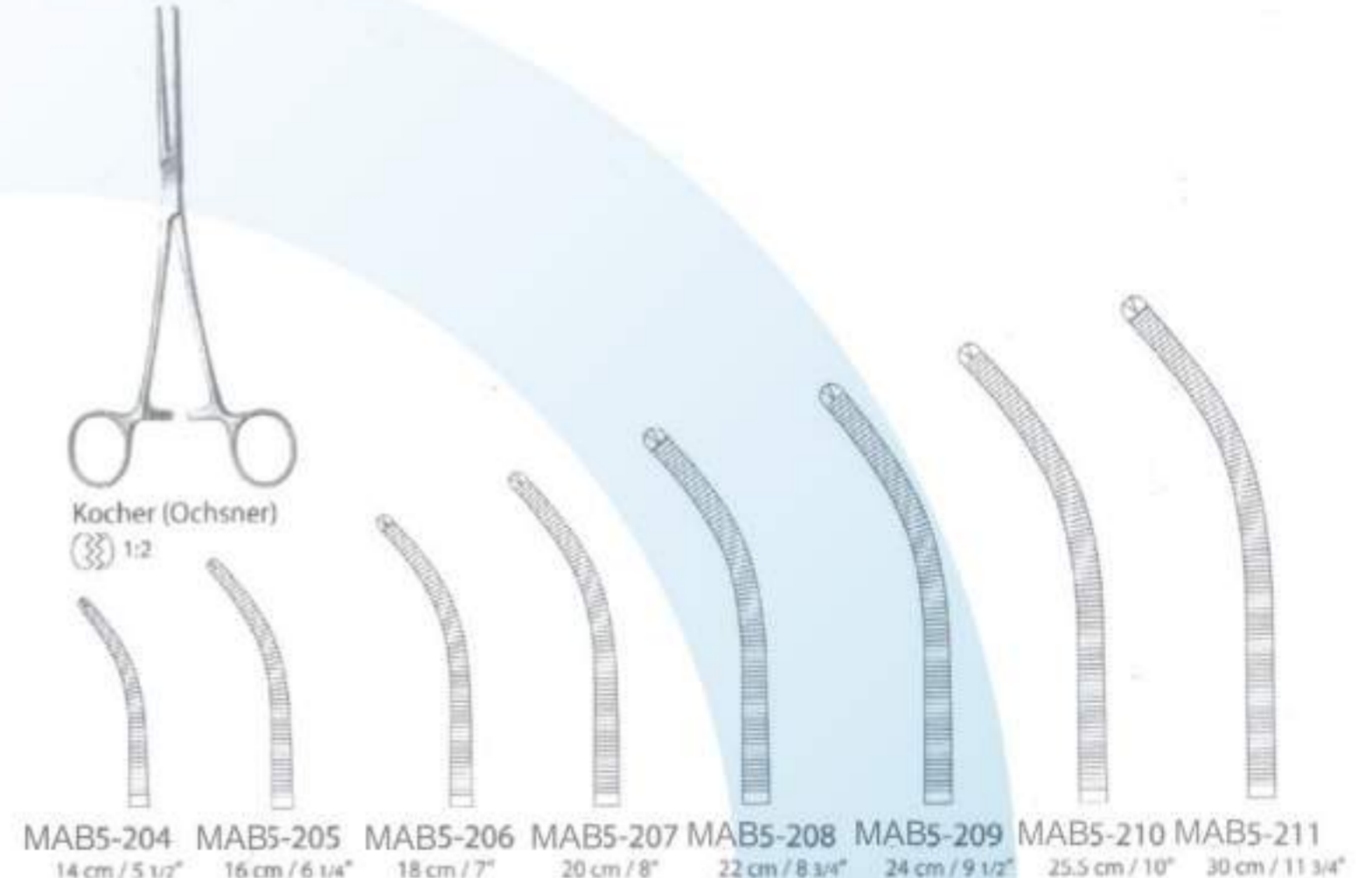
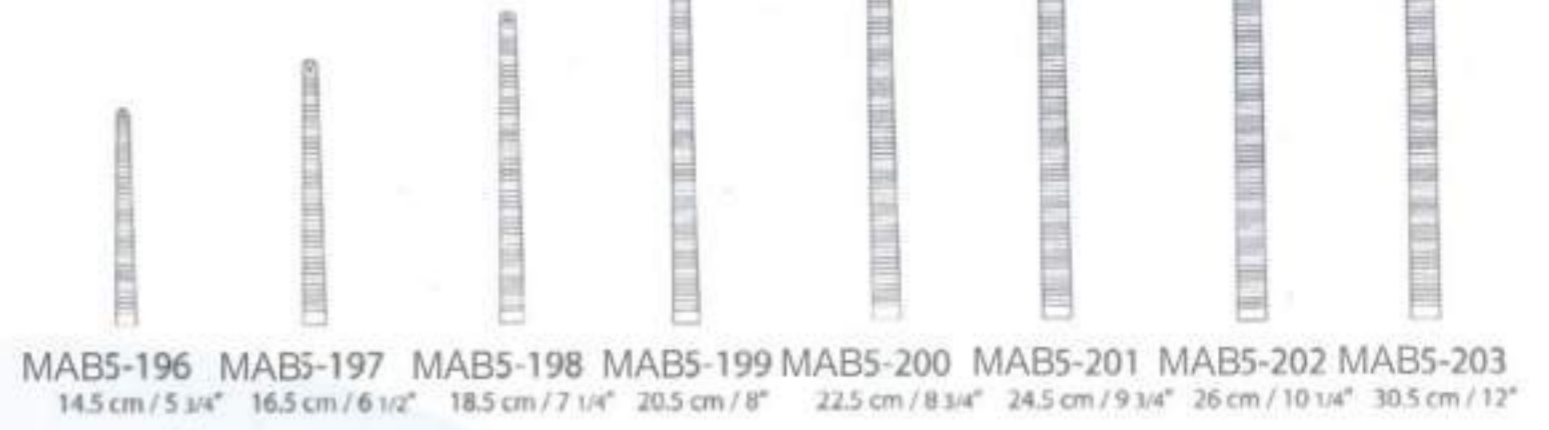

Allgemeines Instrumentarium . Instrumentation générale . Strumentario generale  
 Präparierklemmen  
 Dissecting and Ligature Forceps  
 Pinzas para preparación y ligadura  
 Pinces à disséquer et à ligatures  
 Pinze per preparazioni e legature



Allgemeines Instrumentarium . General Instrumentation . Instrumental general  
 Präparierklemmen  
 Dissecting and Ligature Forceps  
 Pinzas para preparación y ligadura  
 Pinces à disséquer et à ligatures  
 Pinze per preparazioni e legature

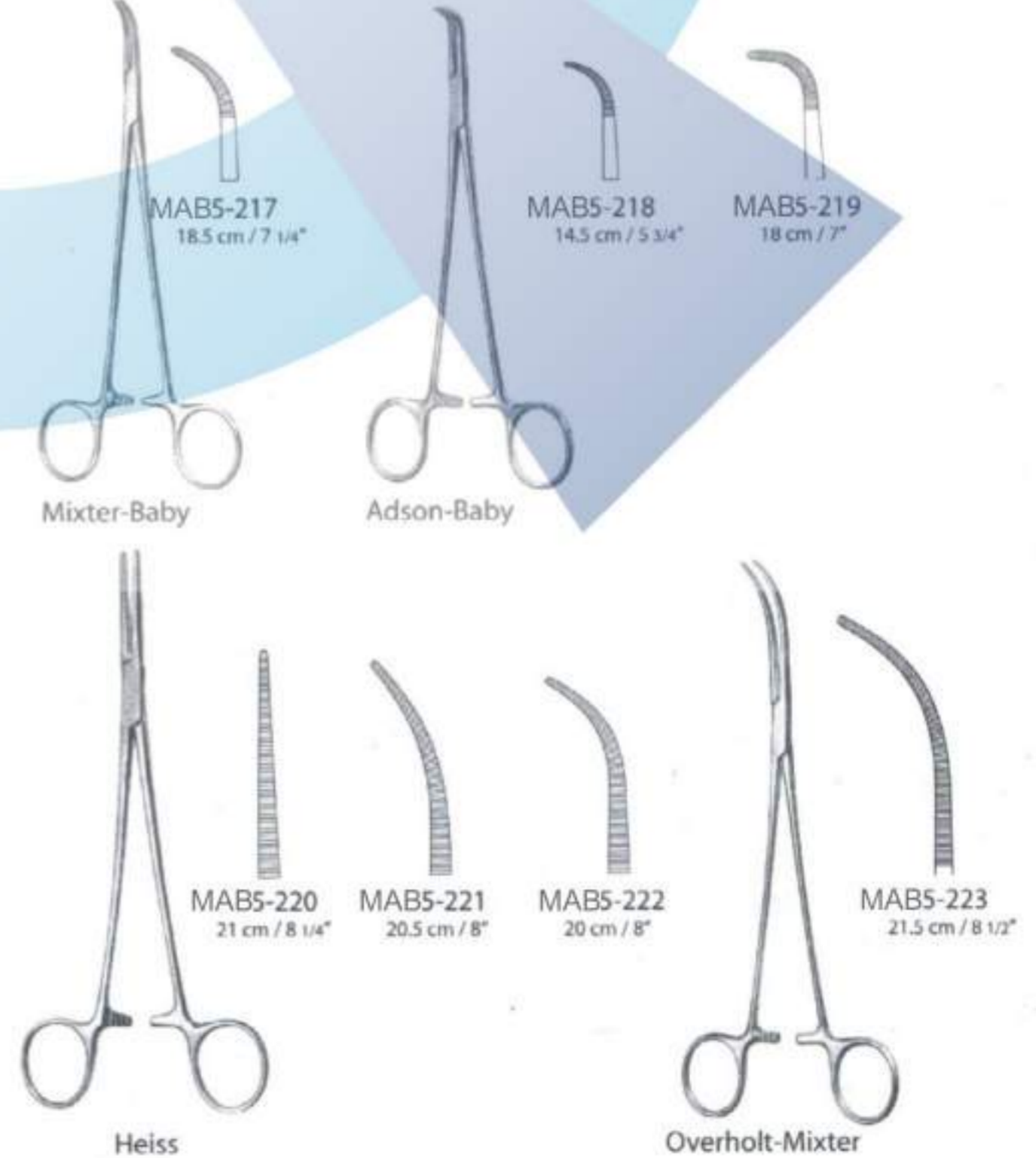



Allgemeines Instrumentarium . Instrumentation générale . Strumentario generale

Präparierklemmen  
Dissecting and Ligature Forceps  
Pinzas para preparación y ligadura  
Pincas à disséquer et à ligatures  
Pinze per preparazioni e legature

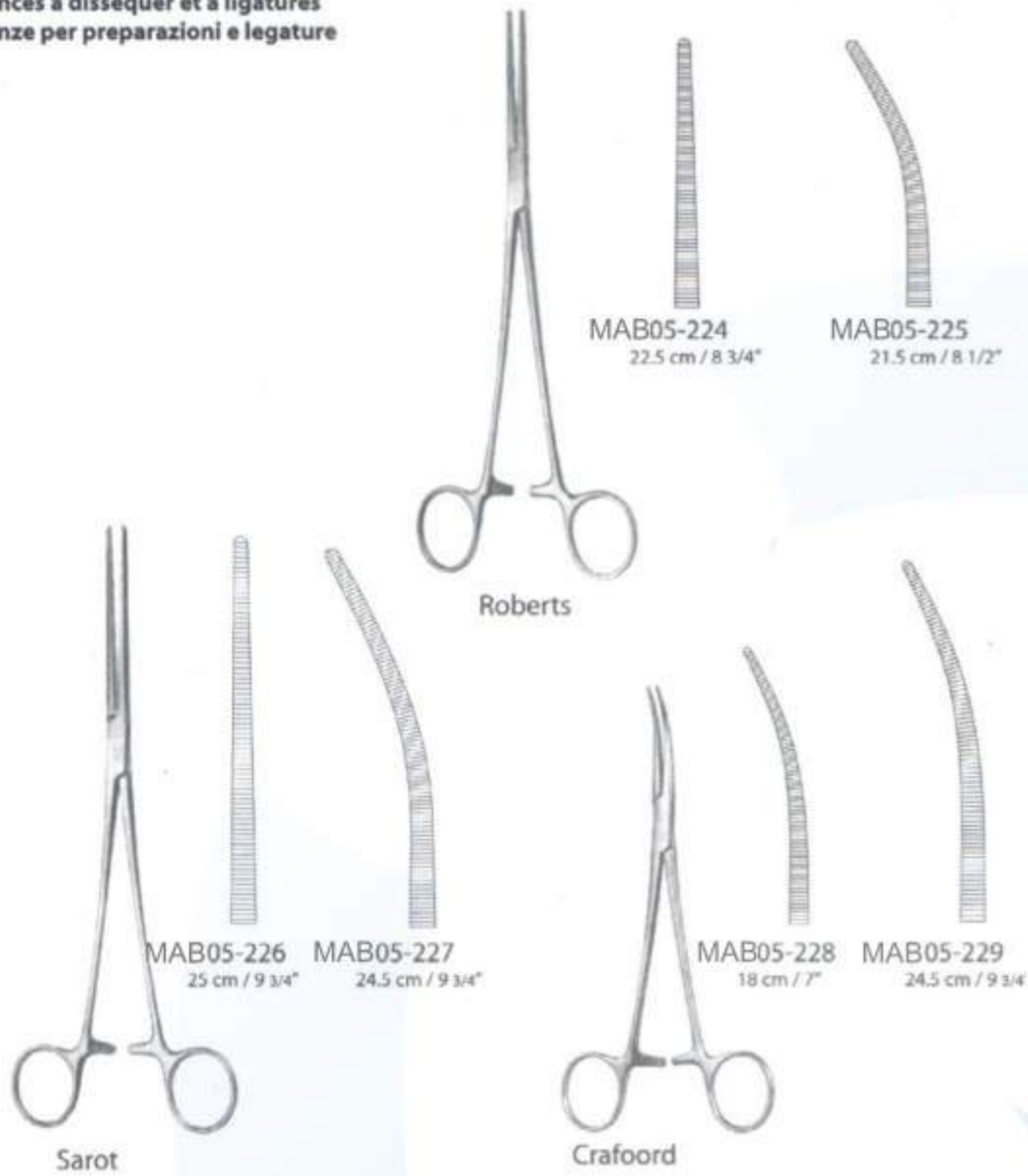

Allgemeines Instrumentarium . General Instrumentation . Instrumental general

Präparierklemmen  
Dissecting and Ligature Forceps  
Pinzas para preparación y ligadura  
Pincas à disséquer et à ligatures  
Pinze per preparazioni e legature

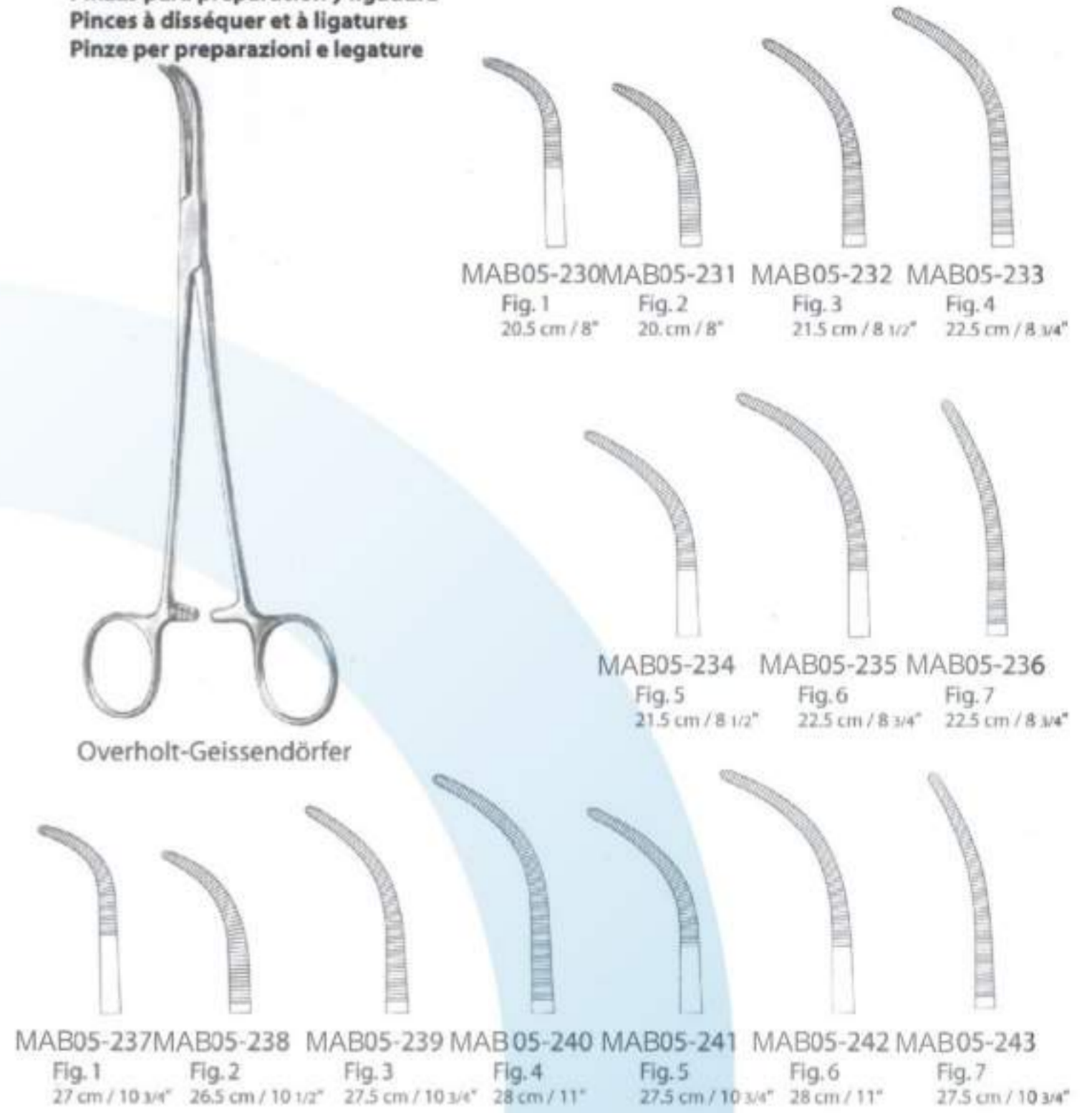

Allgemeines Instrumentarium . Instrumentation générale . Instrumentario generale

Präparierklemmen  
Dissecting and Ligature Forceps  
Pinzas para preparación y ligadura  
Pincas à disséquer et à ligatures  
Pinze per preparazioni e legature

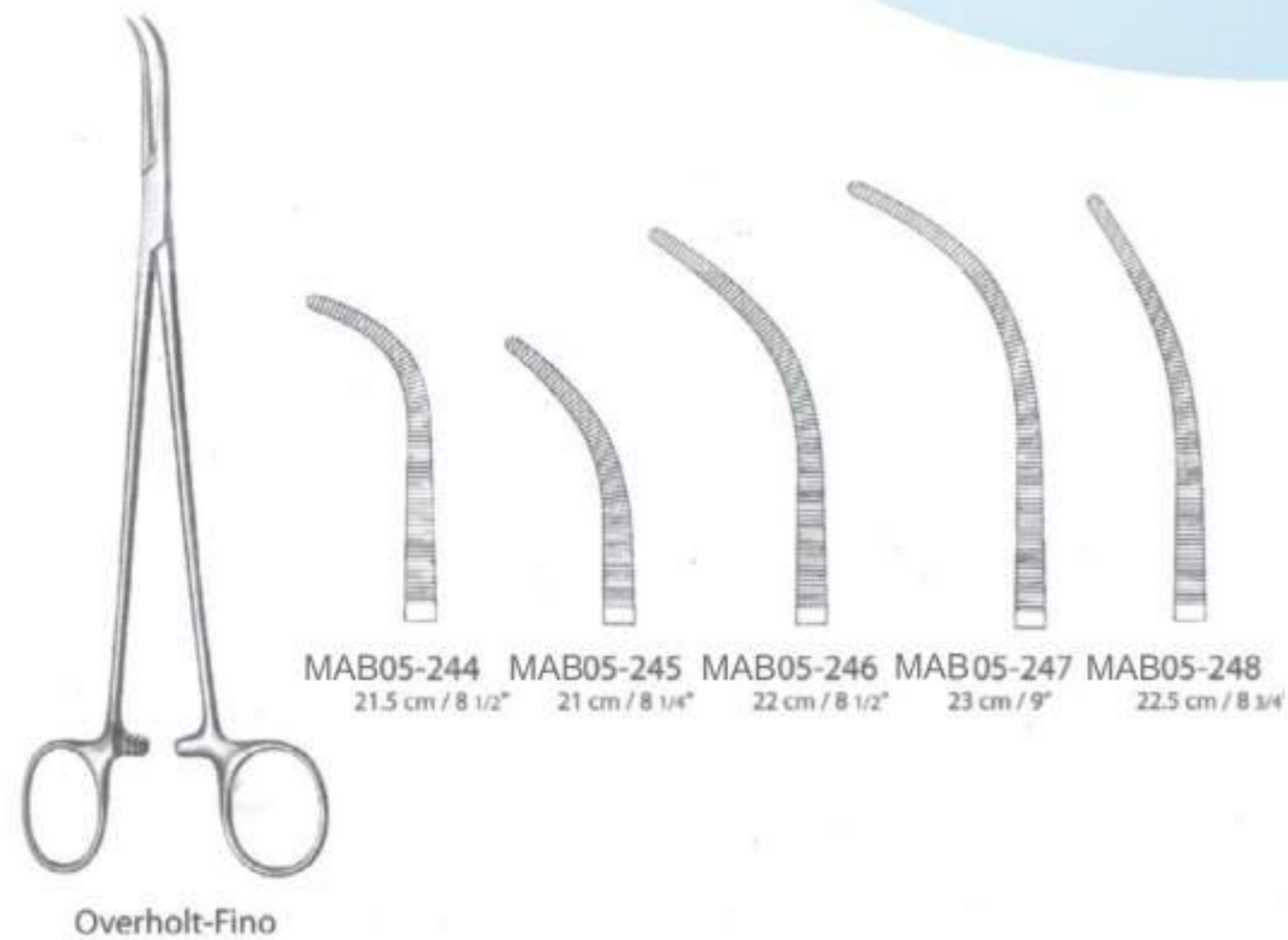

Allgemeines Instrumentarium . General Instrumentation . Instrumental general

Präparierklemmen  
Dissecting and Ligature Forceps  
Pinzas para preparación y ligadura  
Pincas à disséquer et à ligatures  
Pinze per preparazioni e legature

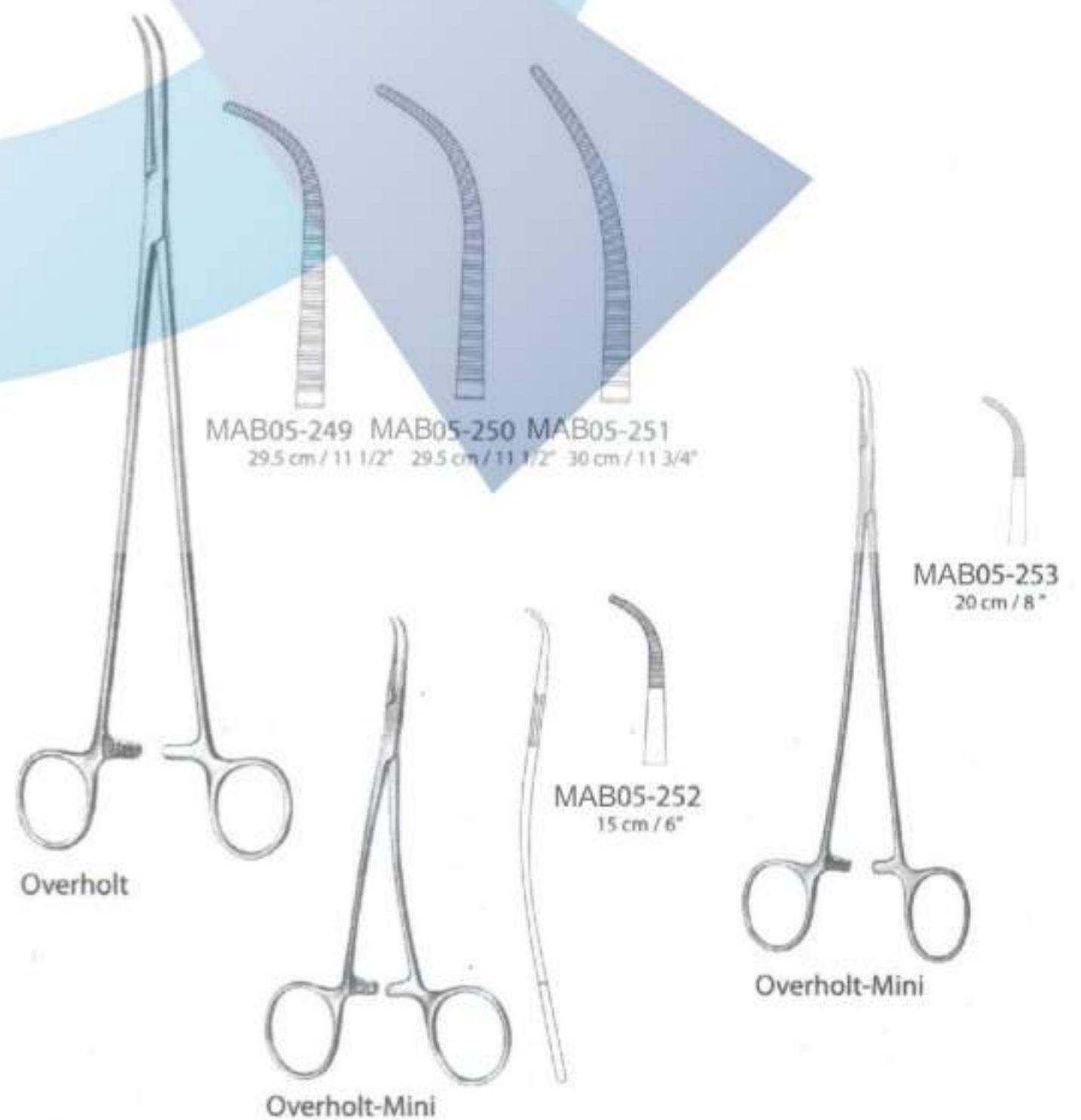



Allgemeines Instrumentarium . Instrumentation générale . Instrumentario generale  
 Präparierklemmen  
 Dissecting and Ligature Forceps  
 Pinzas para preparación y ligadura  
 Pinces à disséquer et à ligatures  
 Pinze per preparazioni e legature

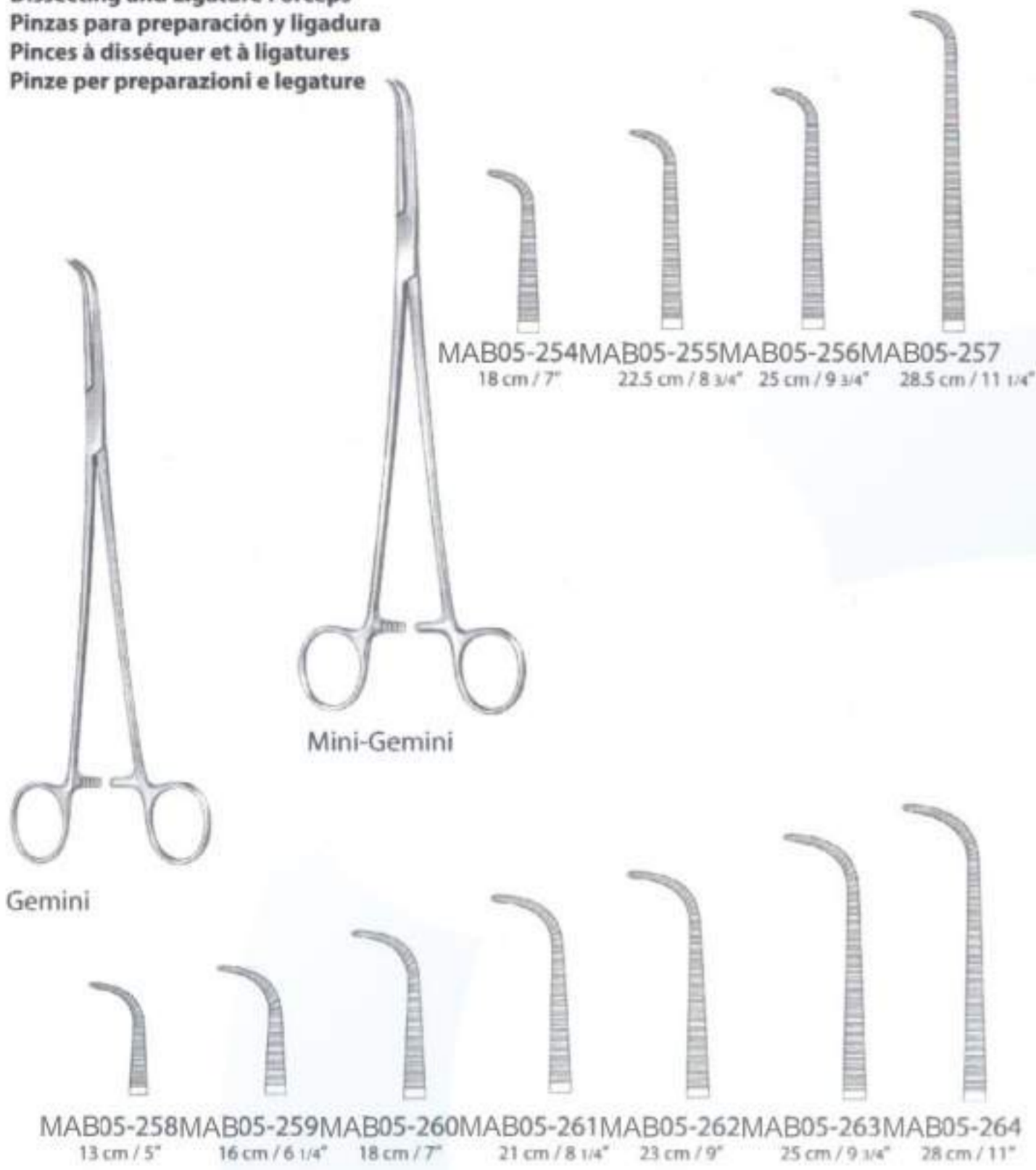

Allgemeines Instrumentarium . General Instrumentation . Instrumental general  
 Präparierklemmen  
 Dissecting and Ligature Forceps  
 Pinzas para preparación y ligadura  
 Pinces à disséquer et à ligatures  
 Pinze per preparazioni e legature



Allgemeines Instrumentarium . Instrumentation générale . Instrumentario generale  
 Präparierklemmen  
 Dissecting and Ligature Forceps  
 Pinzas para preparación y ligadura  
 Pinces à disséquer et à ligatures  
 Pinze per preparazioni e legature



Allgemeines Instrumentarium . General Instrumentation . Instrumental general  
 Präparierklemmen  
 Dissecting and Ligature Forceps  
 Pinzas para preparación y ligadura  
 Pinces à disséquer et à ligatures  
 Pinze per preparazioni e legature

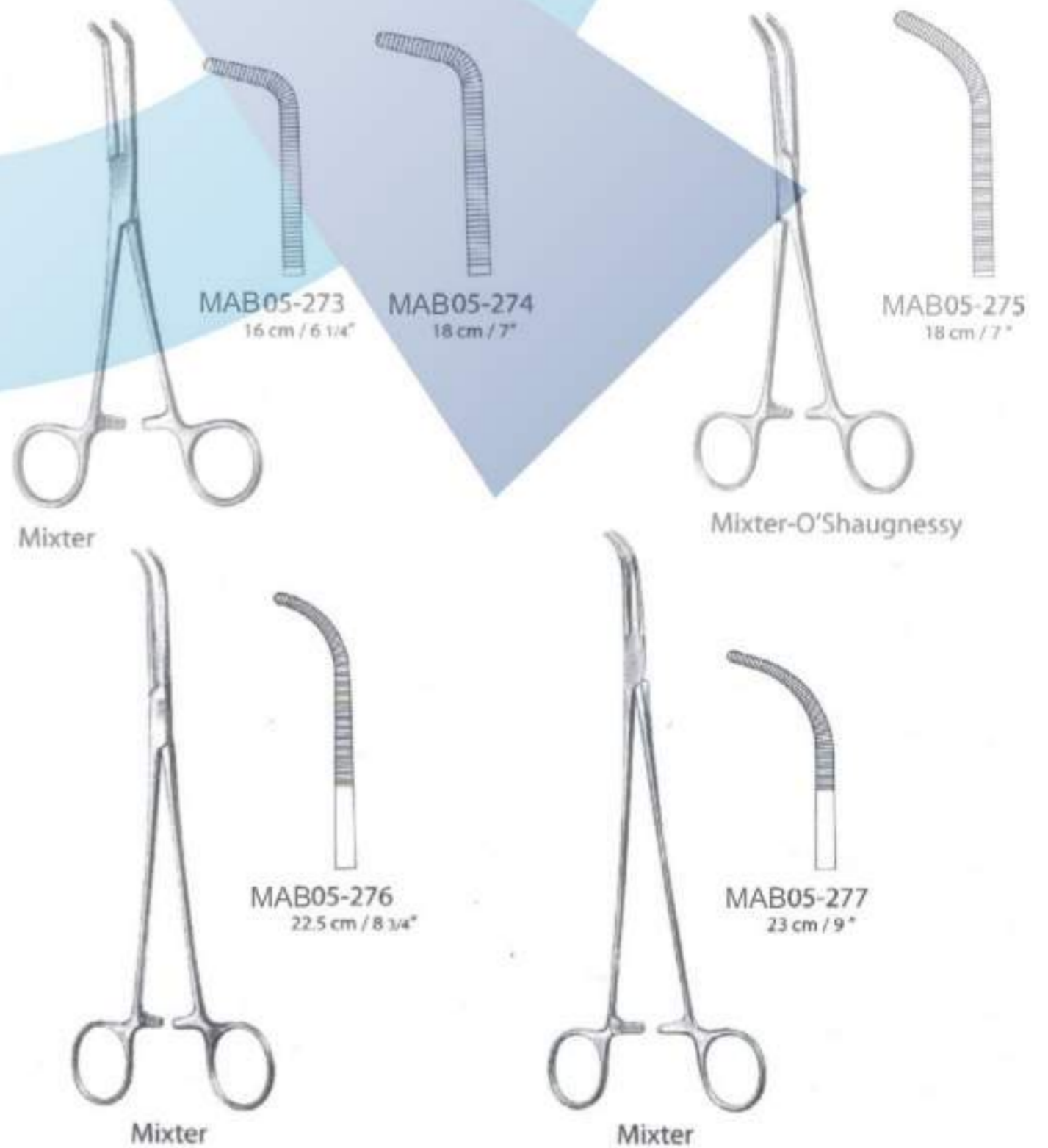



Allgemeines Instrumentarium . Instrumentation générale . Instrumental generale  
 Präparierklemmen  
 Dissecting and Ligature Forceps  
 Pinzas para preparación y ligadura  
 Pincès à disséquer et à ligatures  
 Pinze per preparazioni e legature



Allgemeines Instrumentarium . General Instrumentation . Instrumental general  
 Präparierklemmen, Gallenkanalklemmen  
 Dissecting and Ligature Forceps, Bile Duct Clamps  
 pinzas para preparación y ligatures, pinzas para conducto biliar  
 pincès à disséquer et à ligatures, Pincès pour les voies biliaires  
 pinze per preparazioni e legature, pinze per vie biliari



Allgemeines Instrumentarium . Instrumentation générale . Instrumental generale  
 Präparierklemmen, Tangentialklemmen  
 Dissecting and Ligature Forceps, Tangential Forceps  
 pinzas para preparación y ligatures, pinzas Tangenciales  
 pincès à disséquer et à ligatures, Pincès tangentiels  
 pinze per preparazioni e legature, Pinze tangenziali

Allgemeines Instrumentarium . General Instrumentation . Instrumental general  
 Nierenstiellklemmen  
 Kidney Pedicle Clamps  
 Pinzas para pedículo renal  
 Pince-clamps pour pédicules rénaux  
 Pinze per peduncoli renali

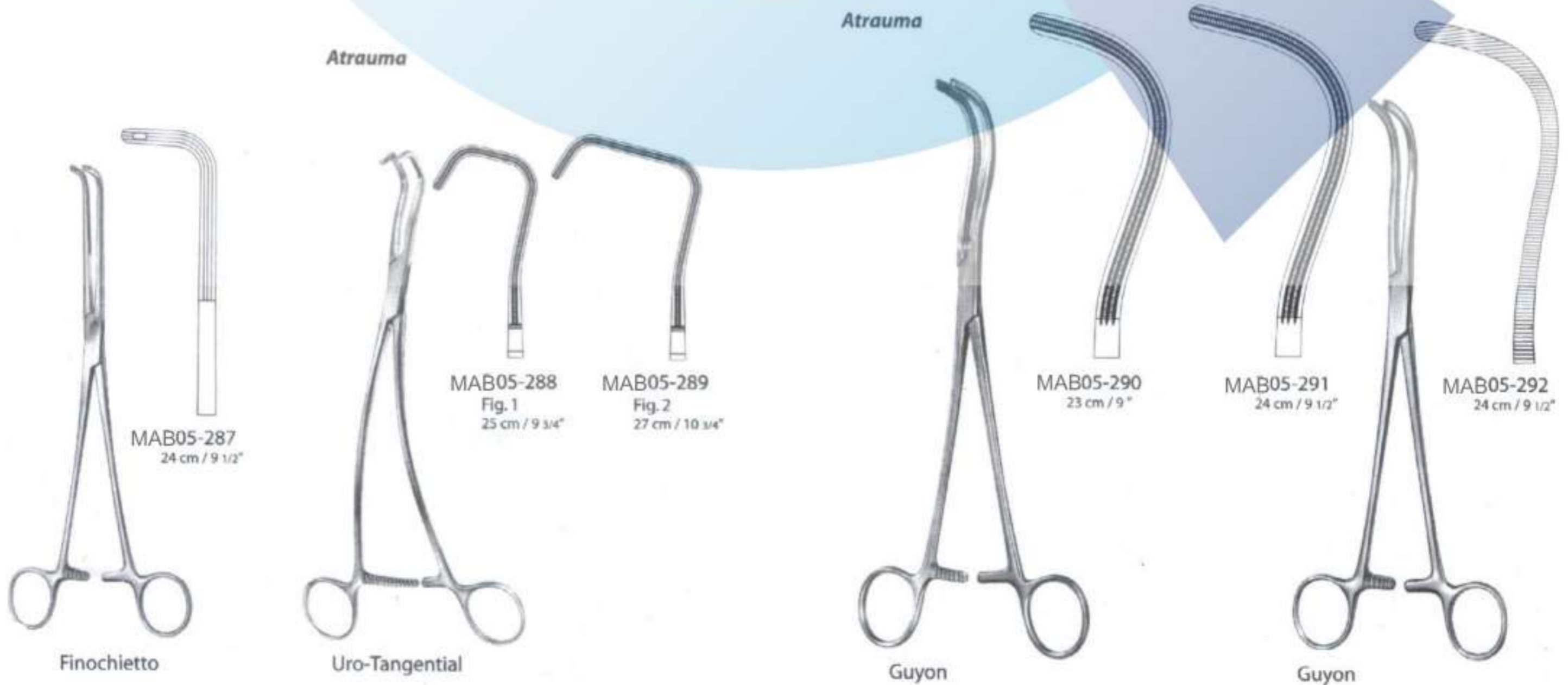



Allgemeines Instrumentarium . Instrumentation générale . Instrumental generale  
 Nierenstieklammen, Gallenkanalklemmen  
 Kidney Pedicle Clamps, Bile Duct Clamps  
 pinzas para pedículo renal, pinzas para conducto biliar  
 pince-clamps pour pédicules rénaux, Pincés pour les voies biliaires  
 pinze per peduncolo renali, pinze per vie biliari

Allgemeines Instrumentarium . General Instrumentation . Instrumental general  
 Präparierklemmen  
 Dissecting and Ligature Forceps  
 Pinzas para preparación y ligadura  
 Pincés à disséquer et à ligatures  
 Pinze per preparazioni e legature

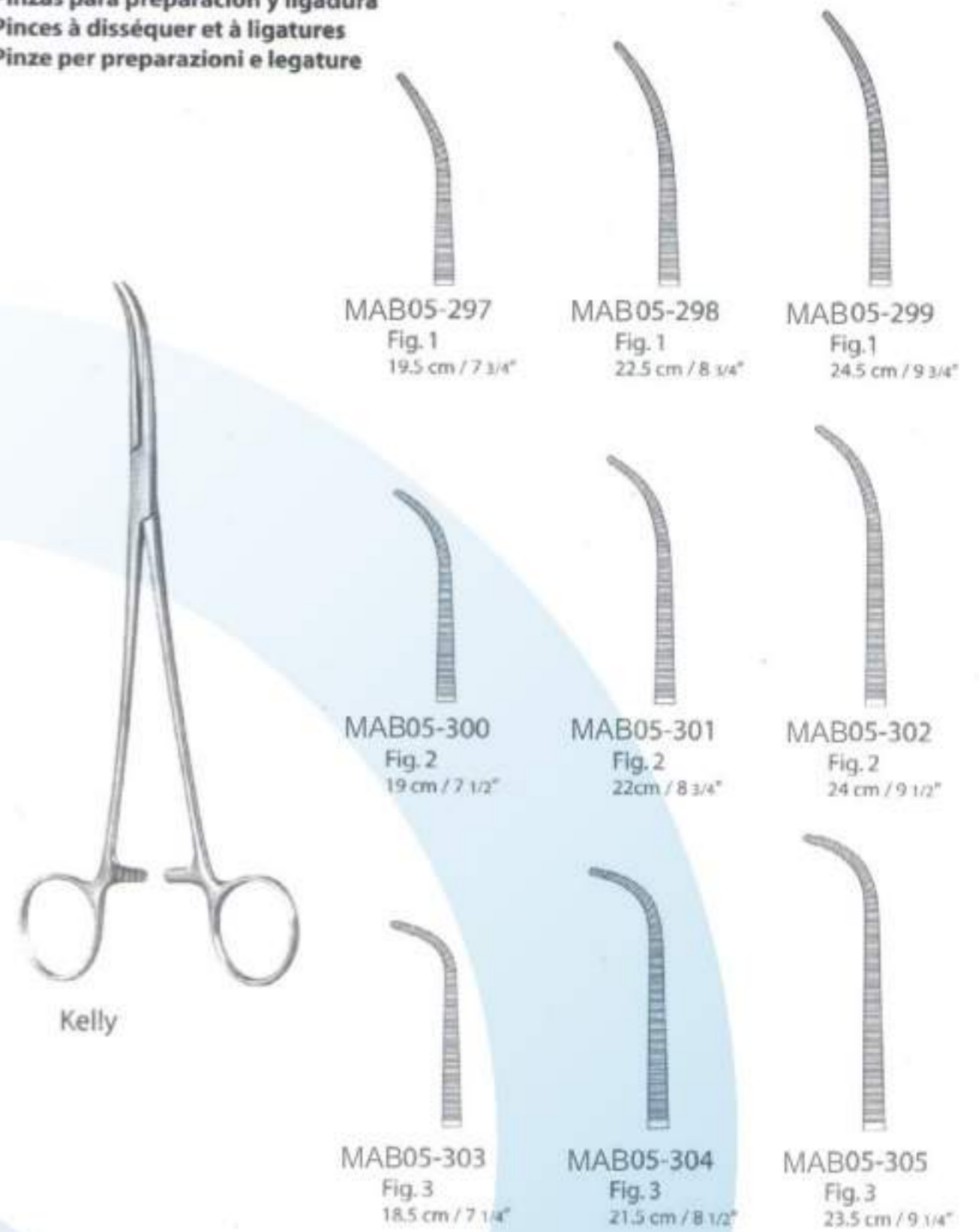

Allgemeines Instrumentarium . Instrumentation générale . Instrumental general  
 Präparierklemmen  
 Dissecting and Ligature Forceps  
 Pinzas para preparación y ligadura  
 Pincés à disséquer et à ligatures  
 Pinze per preparazioni e legature

Allgemeines Instrumentarium . Instrumentation générale . Instrumental general  
 Hysterektomieklammen  
 Hysterectomy Forceps  
 Pinzas para histerectomía  
 Pincés à hystérectomie  
 Pinze per isterectomia

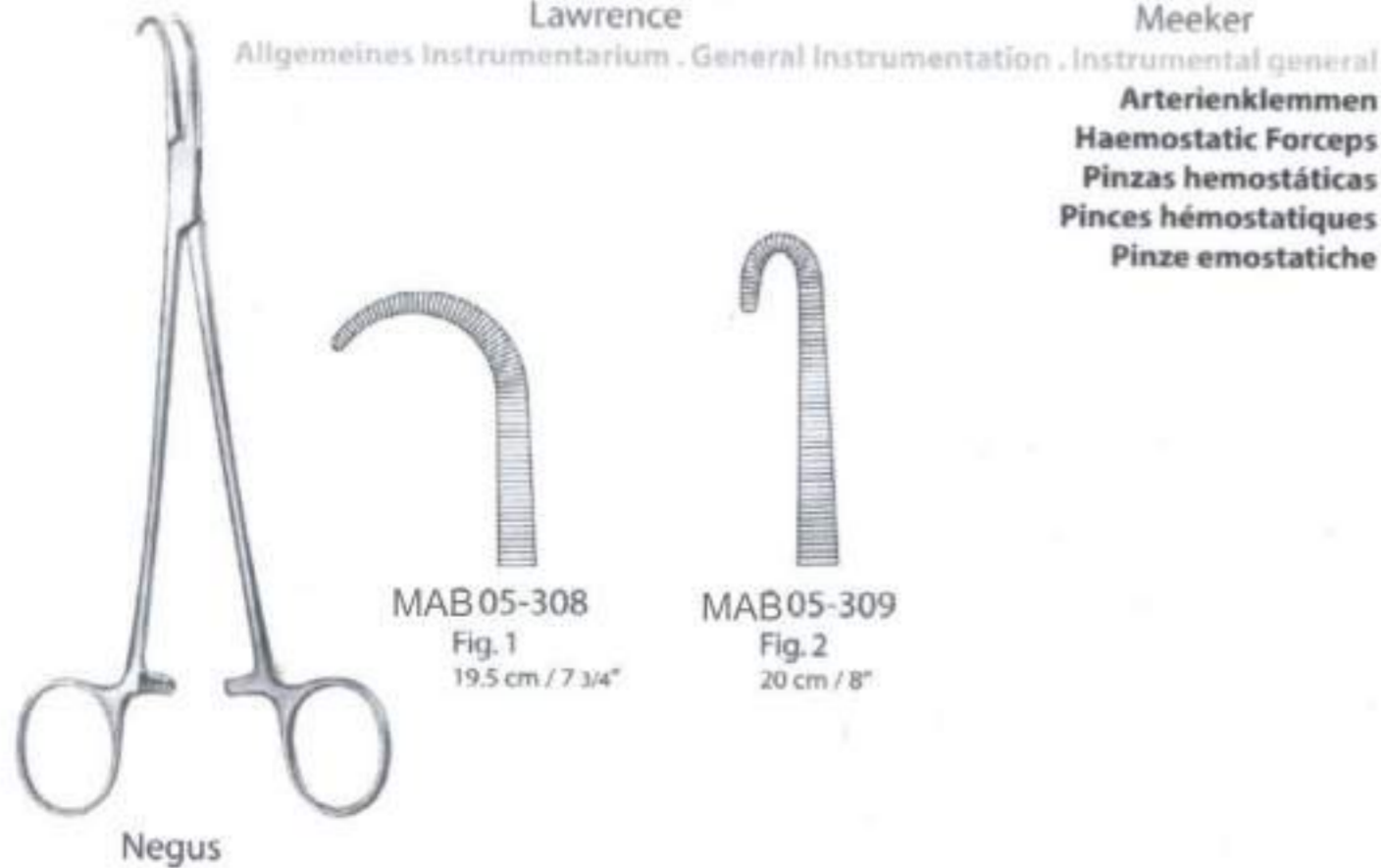
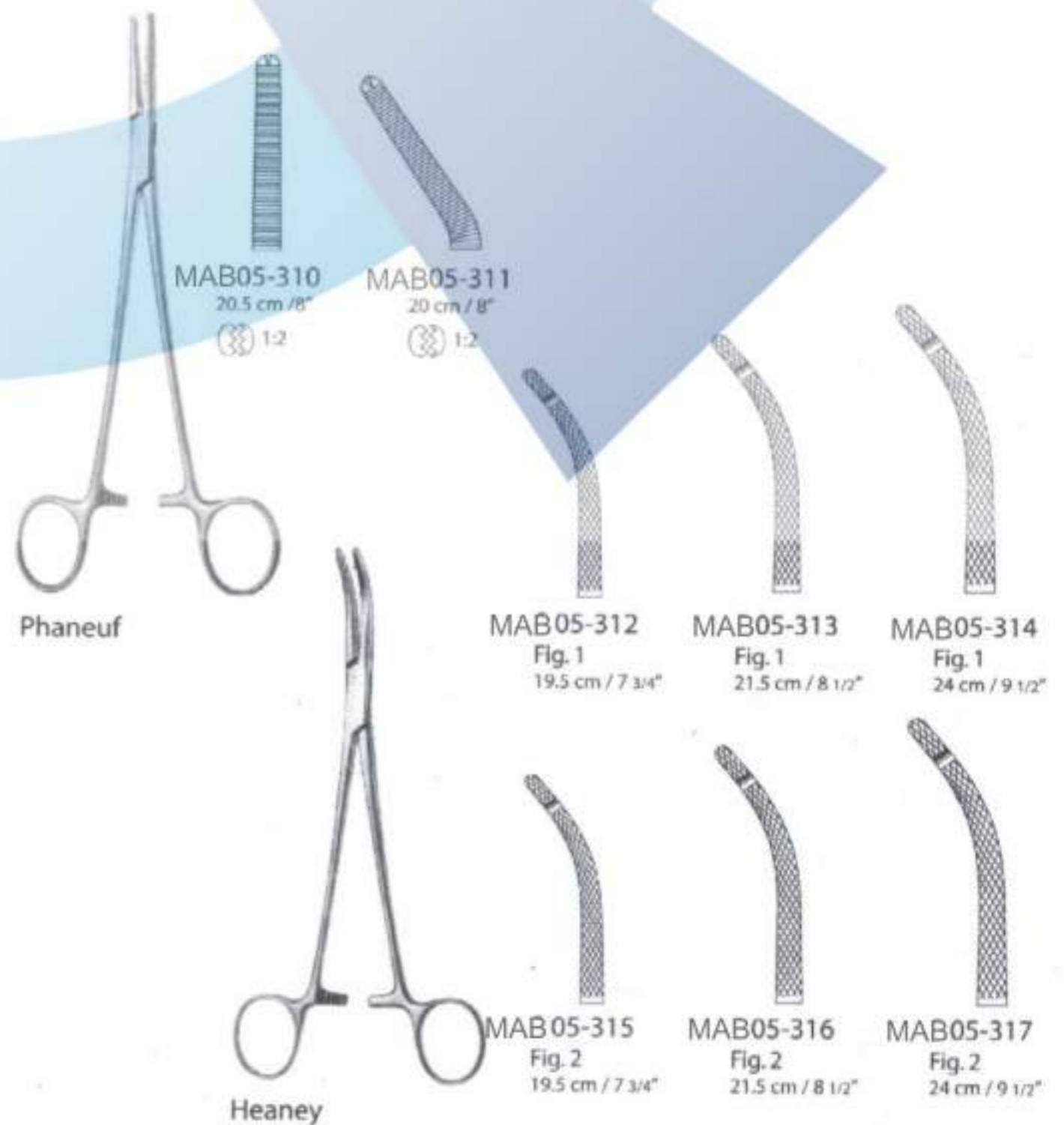



Allgemeines Instrumentarium . General Instrumentation . Instrumental general

Vaginalklemme  
Vaginal Clamp  
Pinza vaginal  
Pinze vagivale  
Pinza vaginale



MAB05-318  
21 cm / 8 1/4"

Wertheim-Cullen

Allgemeines Instrumentarium . General Instrumentation . Instrumental general

Hysterektomieklemmen  
Hysterectomy Forceps  
Pinzas para histerectomia  
Pinces à hystérectomie  
Pinze per isterectomia



MAB05-326  
23 cm / 9"

MAB05-327  
23.5 cm / 9 1/4"

MAB05-328  
26 cm / 10 1/4"

Moynihan

Moynihan

Wertheim

Allgemeines Instrumentarium . Instrumentation générale . Instrumentario generale

Hysterektomieklemmen  
Hysterectomy Forceps  
Pinzas para histerectomia  
Pinces à hystérectomie  
Pinze per isterectomia

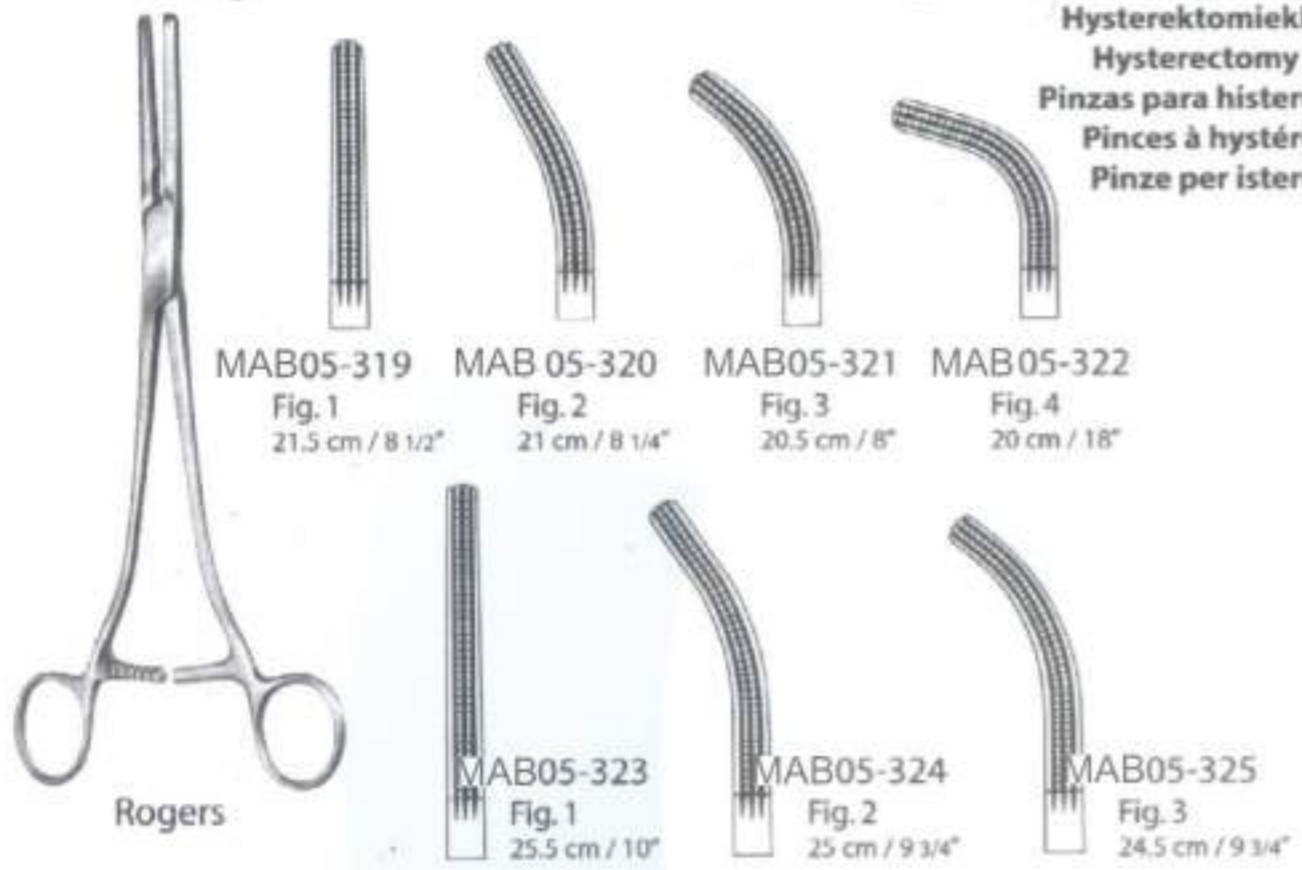

MAB05-319  
Fig. 1  
21.5 cm / 8 1/2"

MAB 05-320  
Fig. 2  
21 cm / 8 1/4"

MAB05-321  
Fig. 3  
20.5 cm / 8"

MAB05-322  
Fig. 4  
20 cm / 8"

MAB05-323  
Fig. 1  
25.5 cm / 10"

MAB05-324  
Fig. 2  
25 cm / 9 3/4"

MAB05-325  
Fig. 3  
24.5 cm / 9 3/4"

Rogers

Allgemeines Instrumentarium . Instrumentation générale . Strumentario generale

Hysterektomieklemmen, Peritoneumklemmen  
Hysterectomy Forceps, Peritoneum Forceps  
Pinzas para histerectomia, Pinzas para peritoneo  
Pinces à hystérectomie, Pince pour le péritoine  
Pinze per isterectomia, Pinze per peritoneo



MAB05-329  
22.5 cm / 8 3/4"  
② 1:2  
leicht gebogen  
slightly curved  
curva ligera  
courbe légère  
curva leggera

MAB05-330  
22.5 cm / 8 3/4"  
② 1:2  
stärker gebogen  
more curved  
curva fuerte  
courbe forte  
curva forte

Wertheim

MAB05-331  
14.5 cm / 5 3/4"  
② 1:2

MAB05-332  
18.5 cm / 7 1/4"  
② 1:2

S 05-333  
20 cm / 8"  
② 1:2

Mikulicz, Baby

Mikulicz

Mikulicz

Allgemeines Instrumentarium . General Instrumentation . Instrumental general

Peritoneumklemmen  
Peritoneum Forceps  
Pinzas para peritoneo  
Pince pour le péritoine  
Pinze per peritoneo



MAB05-334  
20 cm / 8"  
② 1:2

MAB05-335  
20.5 cm / 8"  
② 1:2

MAB05-336  
21 cm / 8 1/4"  
② 1:2

MAB05-337  
21 cm / 8 1/4"  
② 1:2

Mikulicz

Mikulicz

Faure



Allgemeines Instrumentarium . Instrumentation générale . Strumentario generale

Tuchklemmen  
Towel Clamps  
Pinzas de campo  
Pincas à champs  
Pinze fissatele



Schädel  
MAB05-338  
9 cm / 3 1/2"  
scharf  
sharp  
aguda  
aiguë  
acute



MAB05-339  
5.5 cm / 2 1/4"



MAB05-340  
8.5 cm / 3 1/4"

Jones  
scharf  
sharp  
aguda  
aiguë  
acute



mit Schlauchhalter  
with tube holder  
con porta-tubo  
avec clamp porte-tubo

Jones-Martin  
MAB05-341  
8.5 cm / 3 1/4"  
scharf  
sharp  
aguda  
aiguë  
acute



MAB05-342  
11.5 cm / 4 1/2"



MAB05-343  
13 cm / 5"

Backhaus  
graziles Modell  
delicate model  
modelo delicado  
modèle gracile  
modello delicato



mit Schlauchhalter  
with tube holder  
con porta-tubo  
avec clamp porte-tubo  
con porta-tubo

Backhaus  
MAB05-344  
11.5 cm / 4 1/2"



MAB05-345  
9 cm / 3 1/2"

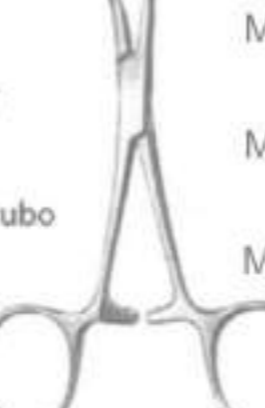

MAB05-346  
11.5 cm / 4 1/2"

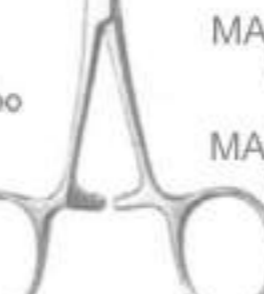

MAB05-347  
13 cm / 5"



MAB05-348  
16 cm / 6 1/4"

Backhaus

Allgemeines Instrumentarium . General Instrumentation . Instrumental general

Tuchklemmen  
Towel Clamps  
Pinzas de campo  
Pincas à champs  
Pinze fissatele



MAB 05-349  
15.5 cm / 6"

Peers-Bertram modif.  
weites Maul zur Schlauchfixierung  
wide jaw for tube fixation  
boca ancha para fijación de tubos  
mors large pour fixation de tube  
morso spalancato per fissare il tubo



Röder  
MAB05-350  
13.5 cm / 5 1/4"



MAB05-351  
9.5 cm / 3 3/4"

S 05-352  
13 cm / 5"

Lorna  
fein gezahntes, breites Maul  
fine serrated, wide jaw  
boca ancha, delicadamente dentada  
mors large avec dents fins  
morso largo, con denti fini



Bernhard  
MAB05-353  
16.5 cm / 6 1/2"

Allgemeines Instrumentarium . Instrumentation générale . Strumentario generale

Tuchklemmen  
Towel Clamps  
Pinzas de campo  
Pincas à champs  
Pinze fissatele



MAB 05-354  
10.5 cm / 4"



MAB05-355  
13.5 cm / 5 1/4"

Tohoku  
stumpf  
blunt  
roma  
moussée  
smusse



MAB 05-356  
14.5 cm / 5 3/4"

Peers-Bertram



MAB05-357  
11.5 cm / 4 1/2"



MAB05-358  
14 cm / 5 1/2"

für papierabdeckung  
for paper clothes  
para paños de papel  
pour couverture en papier  
per copertura di carta



MAB05-359  
19.5 cm / 7 3/4"

Lane

Allgemeines Instrumentarium . General Instrumentation . Instrumental general

Schlauchklemmen  
Tubing Clamps  
Pinzas para tubos  
Pincas presse-tubes  
Pinze serratubi



MAB05-360  
14 cm / 5 1/2"

extra lange Sperre  
extra long ratchet  
cremallera extra larga  
cremailière extrêmement longue  
cremagliera stralunga

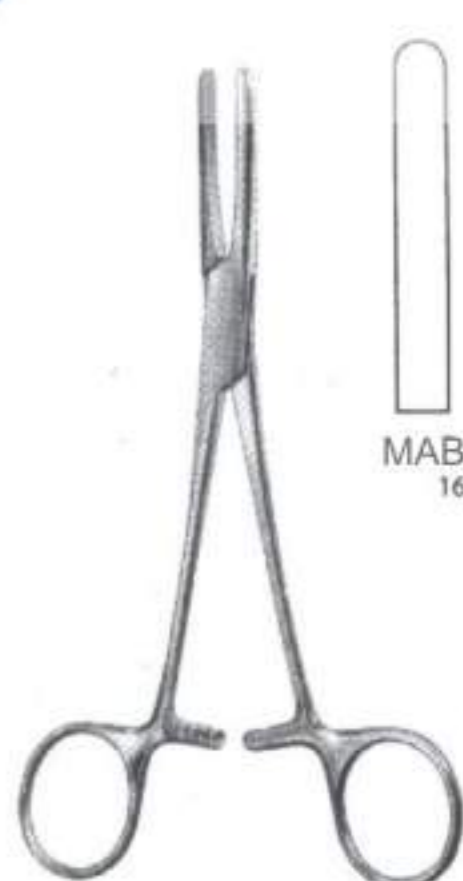

MAB05-361  
16.5 cm / 6 1/2"



Allgemeines Instrumentarium . Instrumentation générale . Instrumentario generale  
 Schlauchklemmen  
 Tubing Clamps  
 Pinzas para tubos  
 Pincas presse-tubes  
 Pinze serratubi



MAB05-362 15.5 cm / 6"  
 MAB05-363 19 cm / 7 1/2"  
 MAB05-364 20.5 cm / 8"



mit Schutzbügel  
 with safety guard  
 con estribo de protección  
 avec protection  
 con protezione



MAB05-365 15.5 cm / 6"  
 MAB05-366 19 cm / 7 1/2"  
 MAB05-367 20.5 cm / 8"

## MAB 06

Tupferzangen  
 Dressing Forceps  
 Pinzas para tapones  
 Pincas a tampons  
 Pinze per tamponi



Allgemeines Instrumentarium . General Instrumentation . Instrumental general  
 Tupferzangen  
 Dressing Forceps  
 Pinzas para tapones  
 Pincas a tampons  
 Pinze per tamponi

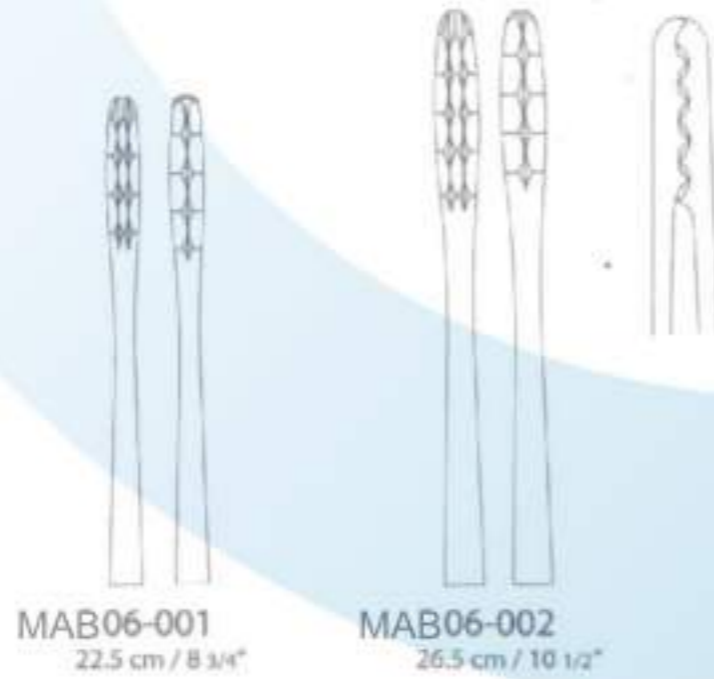

MAB06-001 22.5 cm / 8 3/4"  
 MAB06-002 26.5 cm / 10 1/2"  
 MAB06-003 22.5 cm / 8 3/4"



Ulrich

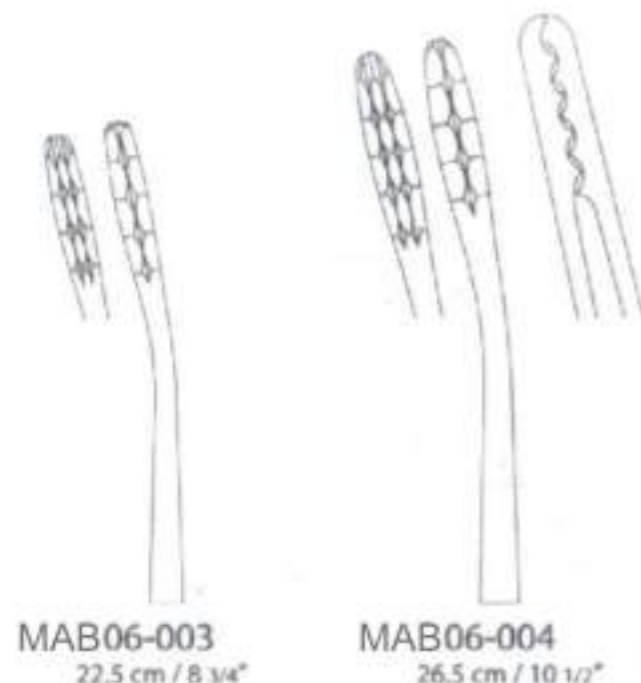

MAB06-003 22.5 cm / 8 3/4"  
 MAB06-004 26.5 cm / 10 1/2"

Allgemeines Instrumentarium . Instrumentation générale . Instrumentario generale  
 Sinusklemmen, Kornzangen  
 Sinus Forceps, Dressing Forceps  
 Pinzas para vendajes  
 Pincas Sinus, Pincas à pansements  
 Pinze per seni, Pinze per medicature



MAB06-005 13 cm / 5"  
 MAB06-006 16 cm / 6 1/4"  
 MAB06-007 18 cm / 7"



Lister



Martin

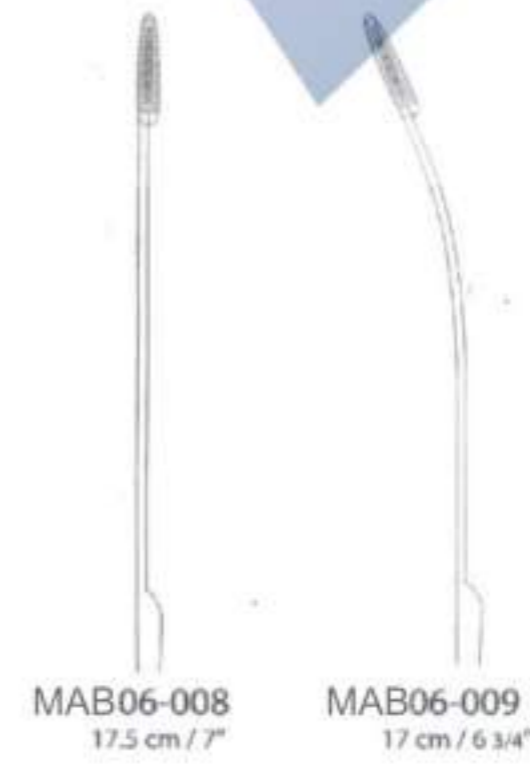

MAB06-008 17.5 cm / 7"  
 MAB06-009 17 cm / 6 3/4"



Allgemeines Instrumentarium . General Instrumentation . Instrumental general  
 Kornzangen  
 Dressing Forceps  
 Pinzas para vendajes  
 Pincas à pansements  
 pinze per medicature



Gross-Maier



MAB06-010  
20.5 cm / 8"



MAB06-013  
20 cm / 8"



MAB06-011  
22 cm / 8 3/4"



MAB06-014  
21.5 cm / 8 1/2"



MAB06-012  
26.5 cm / 10 1/2"



MAB06-015  
26 cm / 10 1/4"

Allgemeines Instrumentarium . General Instrumentation . Instrumental general  
 Kornzangen, Schwammzangen  
 Dressing Forceps, Sponge Forceps  
 Pinzas para vendajes, Pinzas para tapones  
 Pincas à pansements, Pincas pour éponges  
 pinze per medicature, Pinze per tamponi e spugne



Collin

Cheron

Bozemann

Allgemeines Instrumentarium . Instrumentation générale . Strumentario generale

Tunnelier-Kornzange  
 Tunneling Forceps  
 Pinza para tunelar  
 Pince pour tunnelisation  
 Pinza per tunnelare



MAB06-016  
39.5 cm / 15 1/2"

Allgemeines Instrumentarium . Instrumentation générale . Strumentario generale  
 Schwammzangen  
 Sponge Forceps  
 Pinzas para tapones  
 Pincas pour éponges  
 Pinze per tamponi e spugne

Allgemeines Instrumentarium . General Instrumentation . Instrumental general  
 Schwammzangen  
 Sponge Forceps  
 Pinzas para tapones  
 Pincas Pour éponges  
 Pinze per tamponi e spugne



Foerster

MAB06-020  
25 cm / 9 3/4"  
glattes Maul  
smooth jaw  
boca lisa  
mors lisse  
morso liscio

MAB06-021  
18 cm / 7"

MAB06-022  
20.5 cm / 8"

MAB06-023  
25 cm / 9 3/4"

MAB06-024  
24.5 cm / 9 3/4"  
glattes Maul  
smooth jaw  
boca lisa  
mors lisse  
morso liscio

MAB 06-025  
17.5 cm / 7"

MAB 06-026  
20 cm / 8"

MAB 06-027  
24.5 cm / 9 3/4"



Foerster

Rampley

MAB 06-028  
25 cm / 9 3/4"

MAB06-029  
24.5 cm / 9 3/4"

MAB06-030 MAB06-031  
18.5 cm / 7 1/4" 24.5 cm / 9 3/4"



## MAB 07



Wundhaken  
Retractors  
Separadores  
Ecarteurs  
Divaricatori

Allgemeines Instrumentarium . General Instrumentation . Instrumental general

Wundhäkchen, Sattelhäkchen  
Hooklet, Saddle Hooks  
Ganchito, Ganchos en forma de silla  
Crochet, Ecarteurs sous forme de selle  
Divaricatore, Divaricatori a forma di sella  
Titanium

**MAB07-001**  
18.5 cm / 7 1/4"  
Griff aus Titan  
handle made form titanium  
mango de titanio  
manche en titane  
manico in titanio

**MAB07-002**  
17 cm / 6 3/4"  
Griff aus Titan  
handle made form titanium  
mango de titanio  
manche en titane  
manico in titanio

**MAB07-003**  
17 cm / 6 3/4"  
Griff aus Titan  
handle made form titanium  
mango de titanio  
manche en titane  
manico in titanio

Vickers  
Hauthäkchen  
Skin Hooklet  
Ganchito de piel  
Crochet pour la peau  
Divaricatore per pelle

Vickers  
Knochenhäkchen  
Bone Hooklet  
Ganchito para huesos  
Ecarteur à os  
Divaricatore per ossa

Vickers  
Sehnenhäkchen  
Tendon Hooklet  
Ganchito para tendones  
Ecarteur à tendon  
Divaricatore per tendini

**MAB7-004**  
16 cm / 6 1/4"  
Griff aus Titan  
handle made form titanium  
mango de titanio  
manche en titane  
manico in titanio

**MAB7-005**  
16 cm / 6 1/4"  
Griff aus Titan  
handle made form titanium  
mango de titanio  
manche en titane  
manico in titanio

**MAB7-006** **MAB7-007** **MAB7-008**  
14 cm / 5 1/2" 14 cm / 5 1/2" 14 cm / 5 1/2"  
12 mm 14 mm 16 mm  
Griff aus Titan  
handle made form titanium  
mango de titanio  
manche en titane  
manico in titanio

Vickers Vickers Vickers

Allgemeines Instrumentarium . Instrumentation générale . Instrumental generale

Mikrohäkchen, Hauthäkchen  
Micro Hooklets, Skin Hooks  
Micro Ganchitos, Ganchitos de piel  
Micro Crochetes, Crochets pour la peau  
Micro Divaricatori, Divaricatori per pelle

**MAB07-009** **MAB07-010**  
Scharf Sharp stumpf blunt  
agudo agudo romo mousse  
acuto acuto smusso

**MAB07-011** **MAB07-012** **MAB07-013** **MAB07-014**  
Fig. 1 Fig. 2 Fig. 3 Fig. 4

Scharf Sharp  
agudo agudo  
pointu pointu  
acuto acuto

**MAB07-015**  
Scharf Sharp  
agudo agudo  
pointu pointu  
acuto acuto

**MAB07-016** **MAB07-017**  
Scharf Sharp  
agudo agudo  
pointu pointu  
acuto acuto

**MAB07-018** **MAB07-019** **MAB07-020** **MAB07-021**

**MAB07-022** **MAB07-023** **MAB07-024** **MAB07-025**

**MAB07-026** **MAB07-027** **MAB07-028** **MAB07-029**

**MAB07-030** **MAB07-031** **MAB07-032** **MAB07-033**

Graefe 15 cm / 6"  
O'Connor 16 cm / 6 1/4"  
Guthrie 15.5 cm / 6"

Allgemeines Instrumentarium . General Instrumentation . Instrumental general

Wundhäkchen  
Hooklets  
Ganchitos  
Crochets  
Divaricatori

**MAB07-018** **MAB07-019** **MAB07-022** **MAB07-023**

Scharf Sharp  
agudo agudo  
pointu pointu  
acuto acuto

stumpf blunt  
romo romo  
mousse mousse  
smusso smusso

**MAB07-026** **MAB07-027** **MAB07-028** **MAB07-029**

**MAB07-030** **MAB07-031** **MAB07-032** **MAB07-033**

flexibel flexible  
flexible flexible  
flexible flexible

Scharf Sharp  
agudo agudo  
pointu pointu  
acuto acuto

stumpf blunt  
romo romo  
mousse mousse  
smusso smusso







Allgemeines Instrumentarium . Instrumentation générale . Strumentario generale  
**Sattelhäkchen**  
 saddle Hooks  
 Ganchos en forma de silla  
 Ecarteurs sous forme de selle  
 Divaricatori a forma di sella



Allgemeines Instrumentarium . General Instrumentation . Instrumental general  
**Venenhäkchen, Wundhäkchen**  
 Vein Hooks, Hooklets  
 Ganchitos para venas, Ganchitos  
 Ecarteurs pour veines, Crochets  
 Divaricatori per veni, Divaricatori

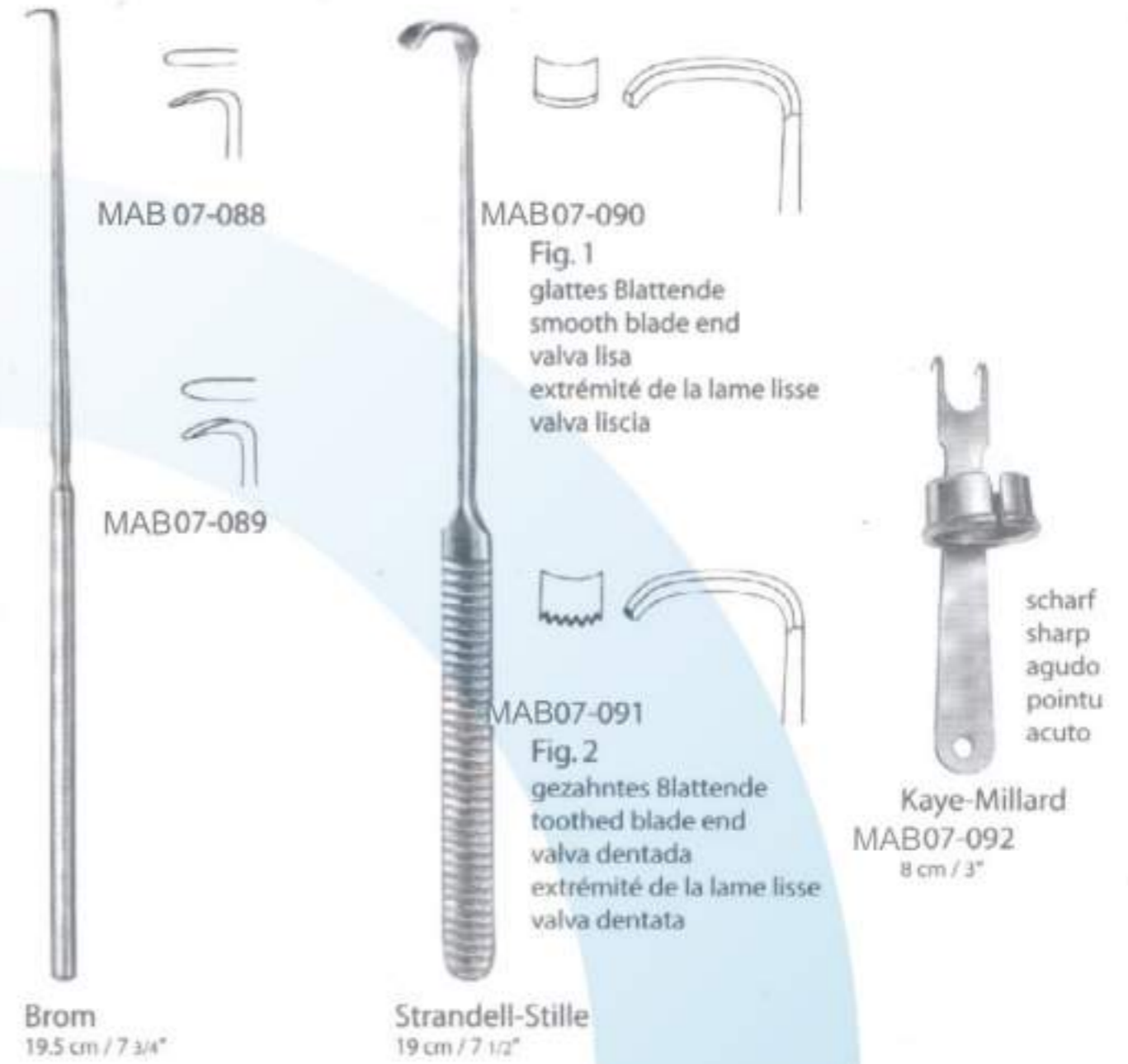

Allgemeines Instrumentarium . Instrumentation générale . Strumentario generale  
**Wundhaken, Wundhäkchen**  
 Retractors, Hooklets  
 Separadores, Ganchitos  
 Ecarteurs, Crochets  
 Divaricatori

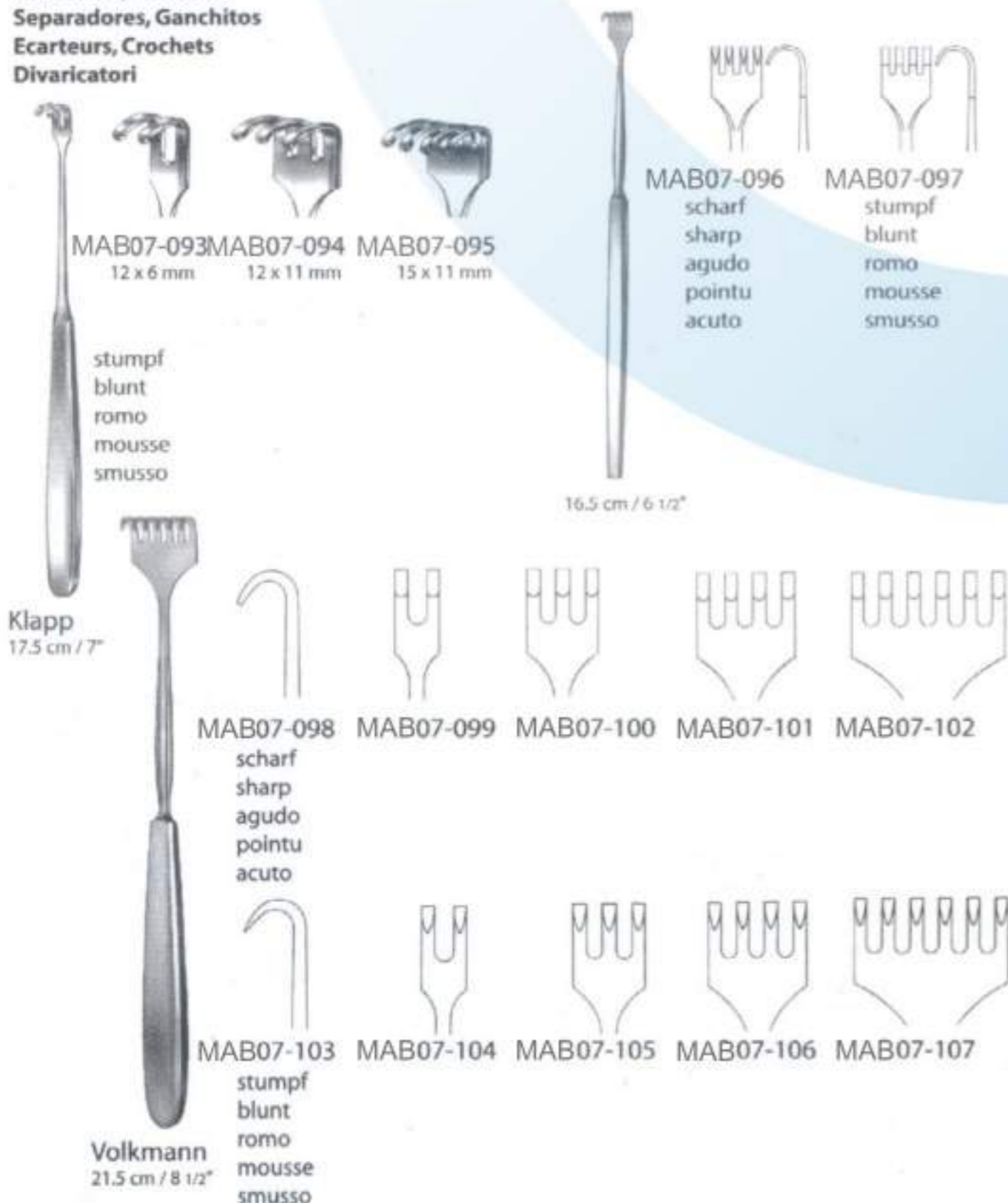

Allgemeines Instrumentarium . General Instrumentation . Instrumental general  
**Wundhaken**  
 Retractors  
 Separadores  
 Ecarteurs  
 Divaricatori

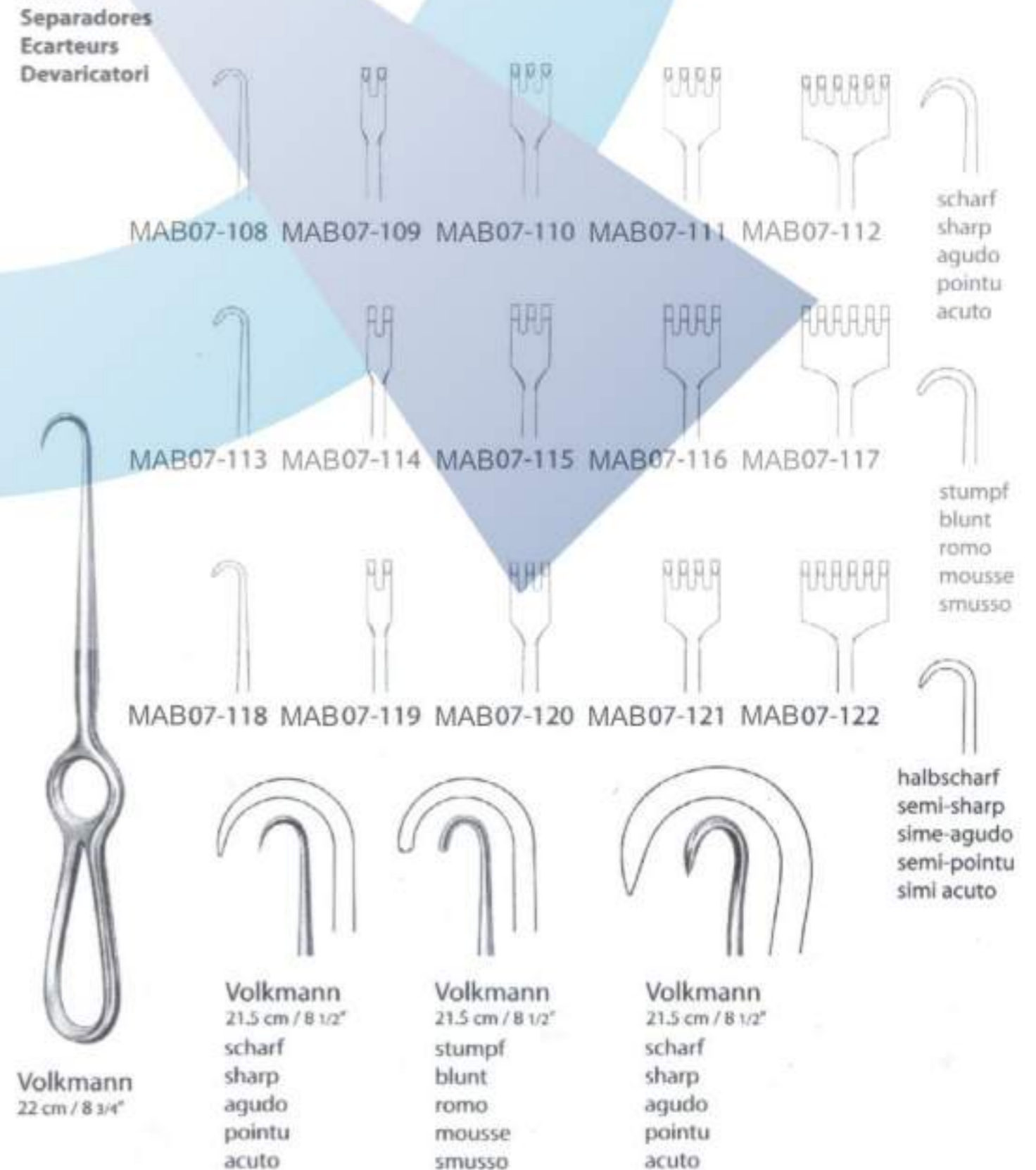



Allgemeines Instrumentarium . Instrumentation générale . Strumentario generale

Wundhaken  
Retractors  
Separadores  
Ecarteurs  
Devaricatori

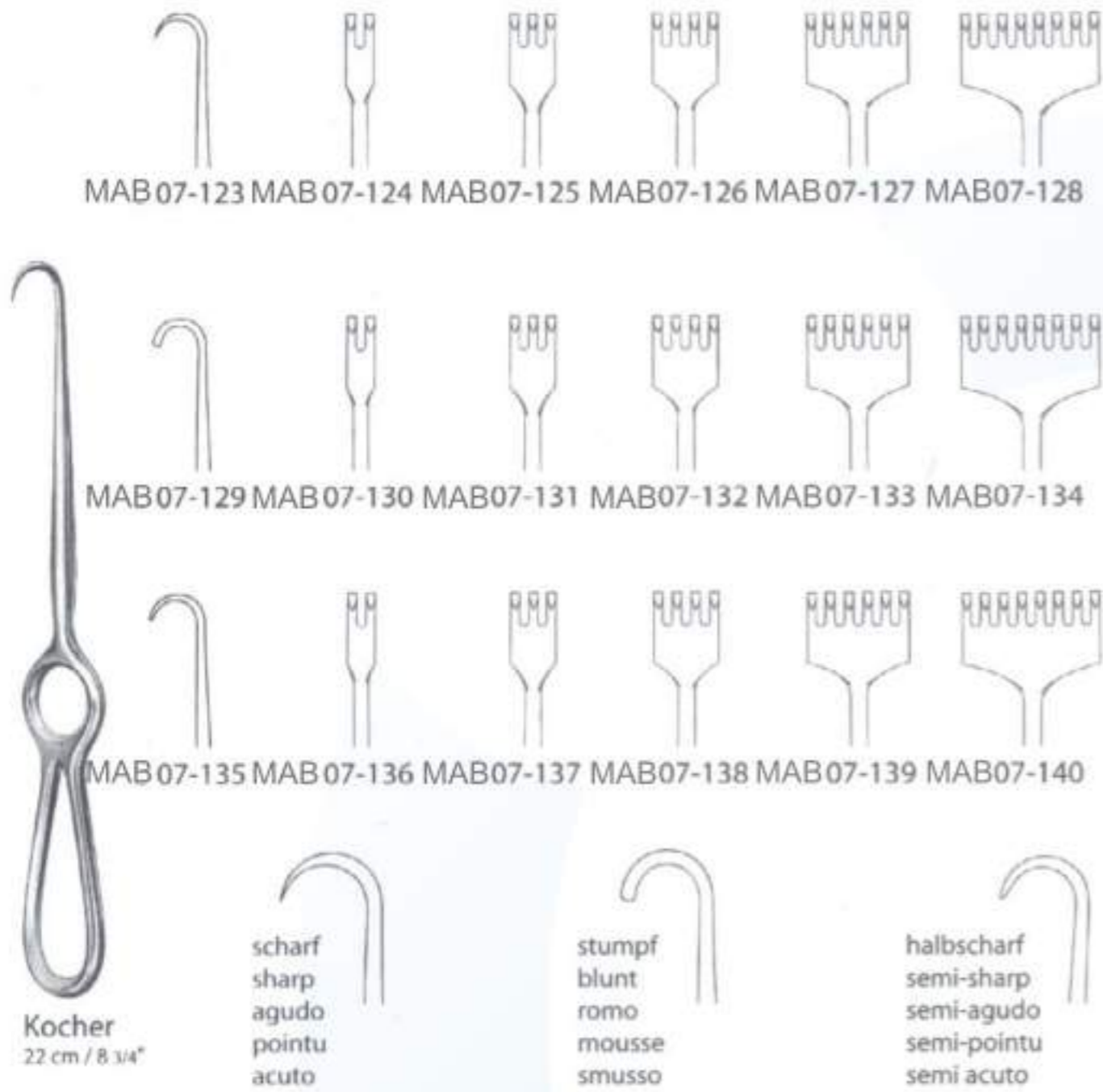

Allgemeines Instrumentarium . General Instrumentation . Instrumental general

Wundhaken  
Retractors  
Separadores  
Ecarteurs  
Devaricatori

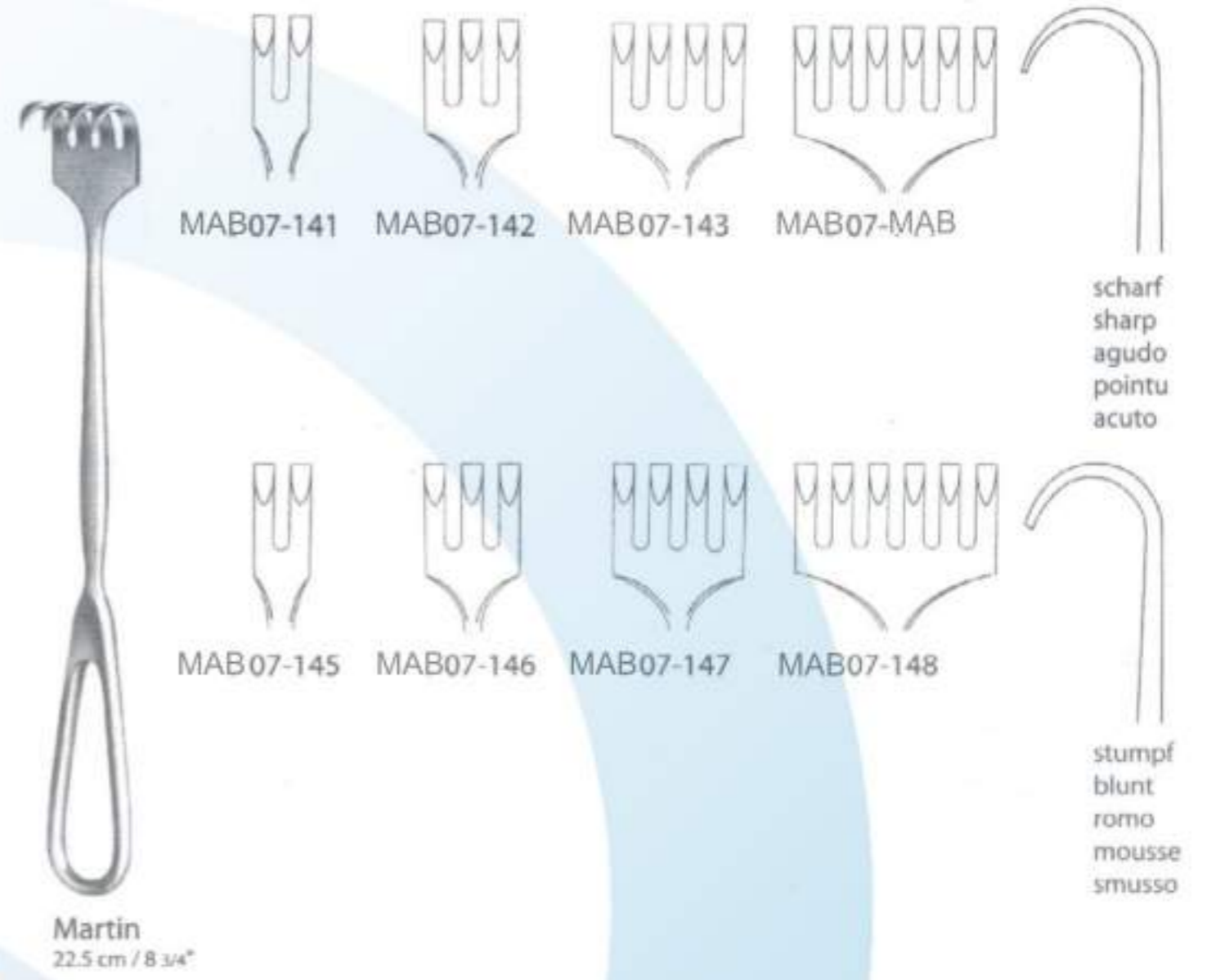

Allgemeines Instrumentarium . Instrumentation générale . Strumentario generale

Wundhaken  
Retractors  
Separadores  
Ecarteurs  
Devaricatori



Allgemeines Instrumentarium . General Instrumentation . Instrumental general

Wundhaken  
Retractors  
Separadores  
Ecarteurs  
Devaricatori





Allgemeines Instrumentarium . Instrumentation générale . Strumentario generale

Wundhaken  
Retractors  
Separadores  
Ecarteurs  
Divaricatori



Allgemeines Instrumentarium . General Instrumentation . Instrumental general

Wundhaken  
Retractors  
Separadores  
Ecarteurs  
Divaricatori

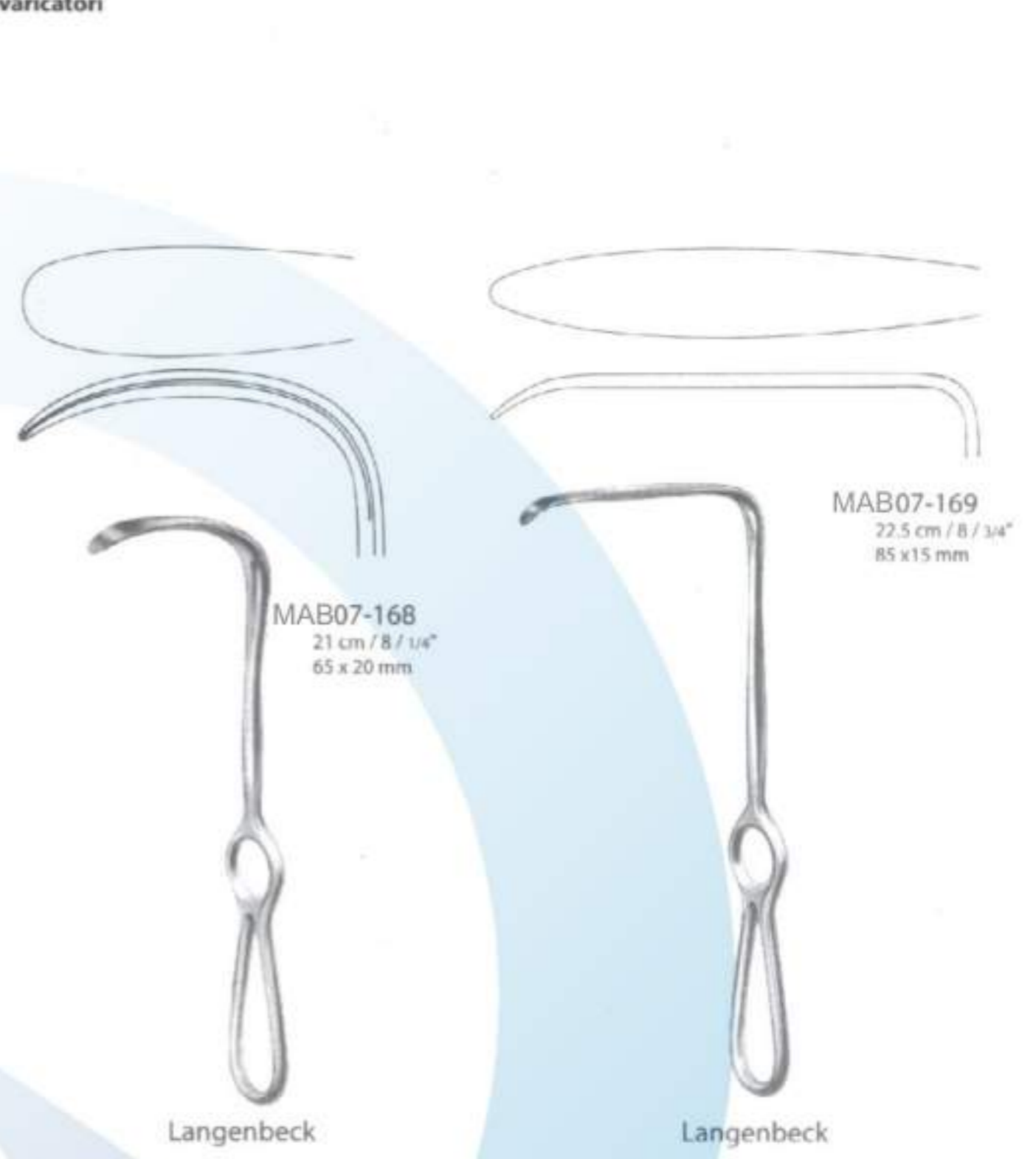

Allgemeines Instrumentarium . Instrumentation générale . Strumentario generale

Wundhaken  
Retractors  
Separadores  
Ecarteurs  
Divaricatori



Allgemeines Instrumentarium . General Instrumentation . Instrumental general

Wundhaken  
Retractors  
Separadores  
Ecarteurs  
Divaricatori





Allgemeines Instrumentarium . Instrumentation générale. Strumentario generale  
 Wundhaken  
 Retractors  
 Separadores  
 Ecarteurs  
 Divaricatori

Allgemeines Instrumentarium . General Instrumentation . Instrumental general  
 Wundhaken  
 Retractors  
 Separadores  
 Ecarteurs  
 Divaricatori



Kocher-Langenbeck



Kocher-Langenbeck

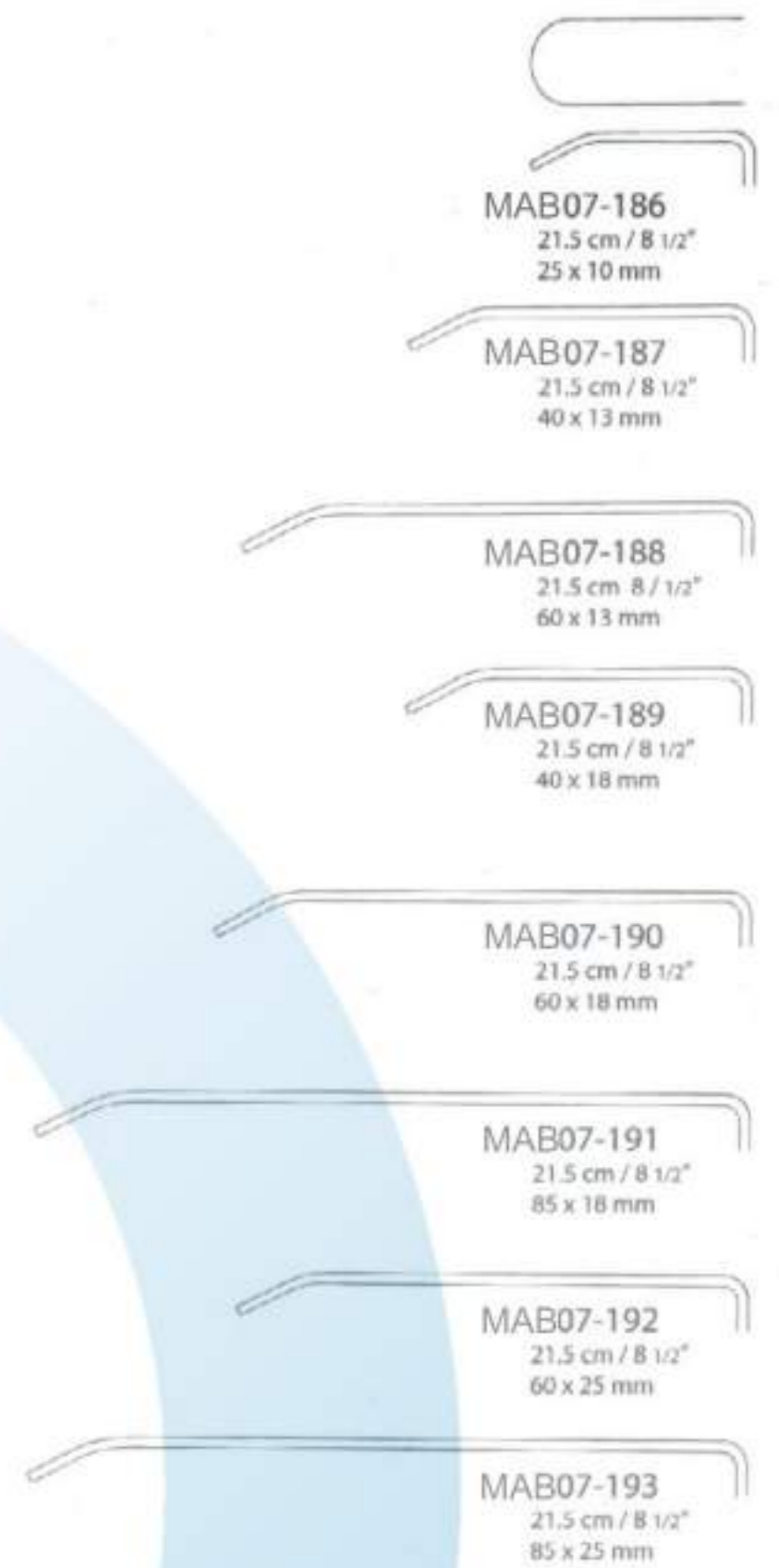

Allgemeines Instrumentarium . Instrumentation générale. Strumentario generale  
 Wundhaken  
 Retractors  
 Separadores  
 Ecarteurs  
 Divaricatori

Allgemeines Instrumentarium . General Instrumentation . Instrumental general  
 Wundhaken  
 Retractors  
 Separadores  
 Ecarteurs  
 Divaricatori



Zenker

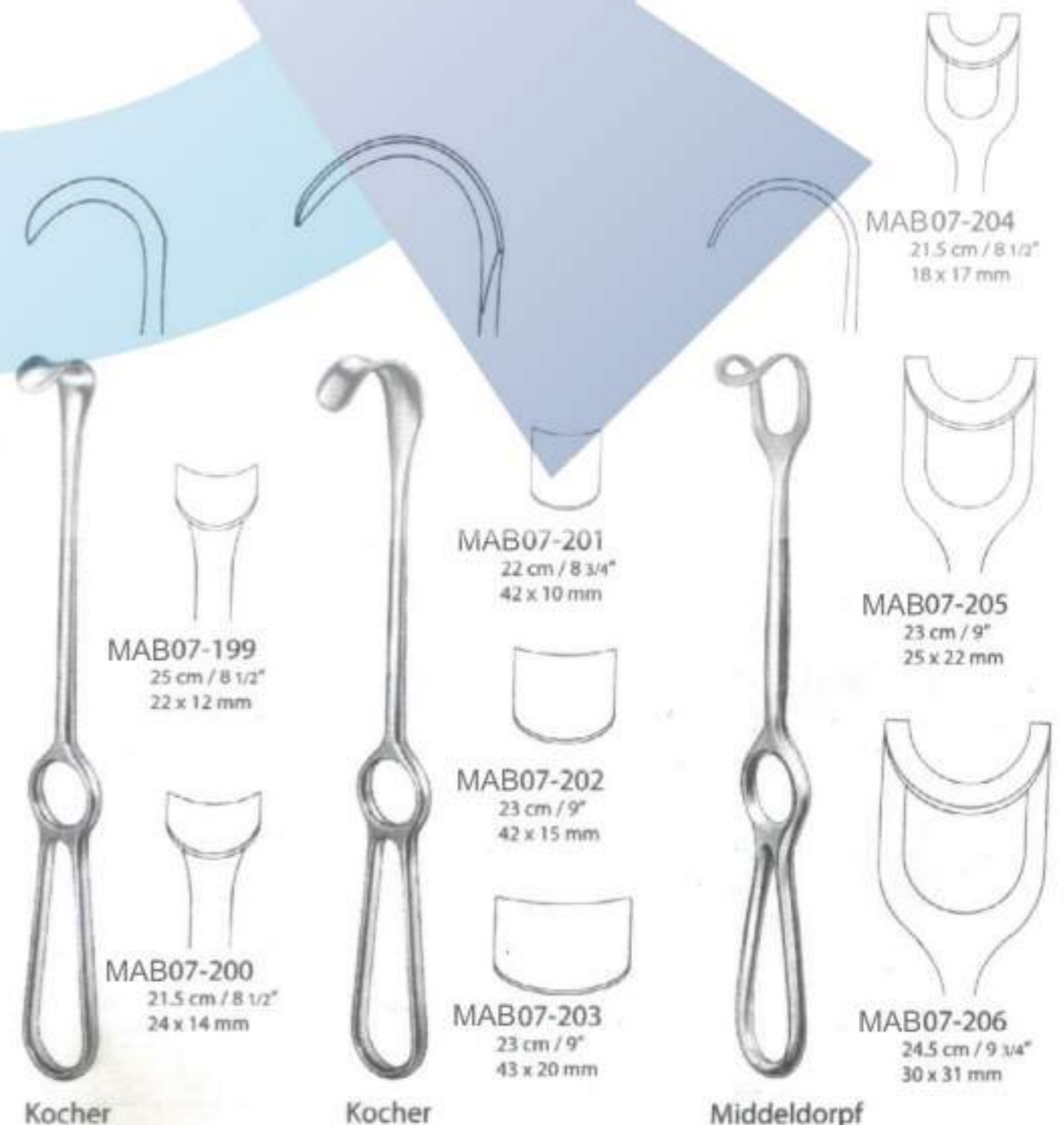
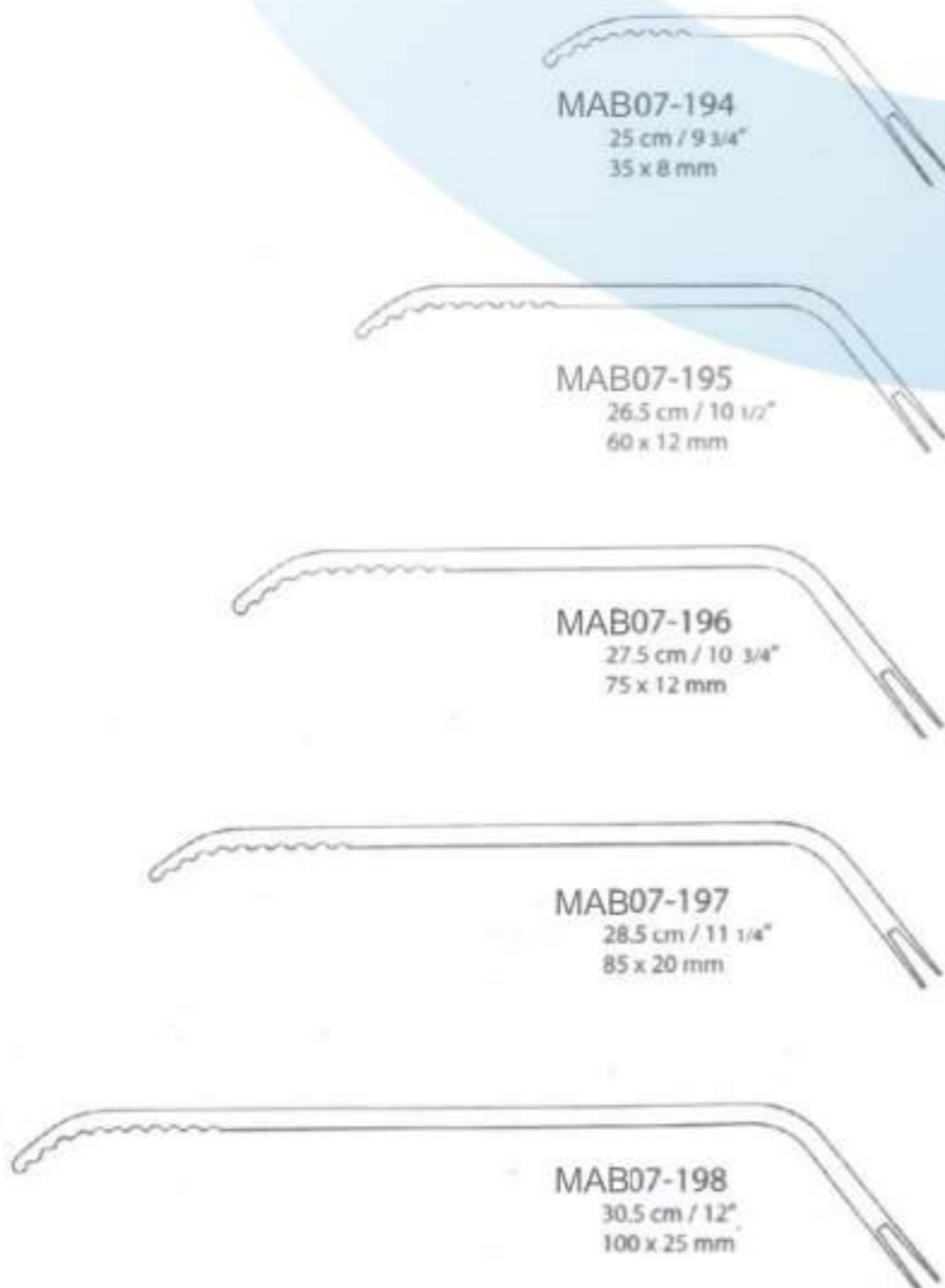

Kocher

Kocher

Middeldorpf



Allgemeines Instrumentarium . Instrumentation générale . Strumentario generale

Wundhaken  
Retractors  
Separadores  
Ecarteurs  
Divaricatori



Allgemeines Instrumentarium . General Instrumentation . Instrumental general

Wundhaken  
Retractors  
Separadores  
Ecarteurs  
Divaricatori



Allgemeines Instrumentarium . Instrumentation générale . Strumentario generale

Wundhaken  
Retractors  
Separadores  
Ecarteurs  
Divaricatori



Allgemeines Instrumentarium . General Instrumentation . Instrumental general

Wundhaken  
Retractors  
Separadores  
Ecarteurs  
Divaricatori





Allgemeines Instrumentarium . Instrumentation générale . Strumentario generale  
 Wundhaken  
 Retractors  
 Separadores  
 Ecarteurs  
 Divaricatori

Allgemeines Instrumentarium . General Instrumentation . Instrumental general  
 Wundhaken  
 Retractors  
 Separadores  
 Ecarteurs  
 Divaricatori

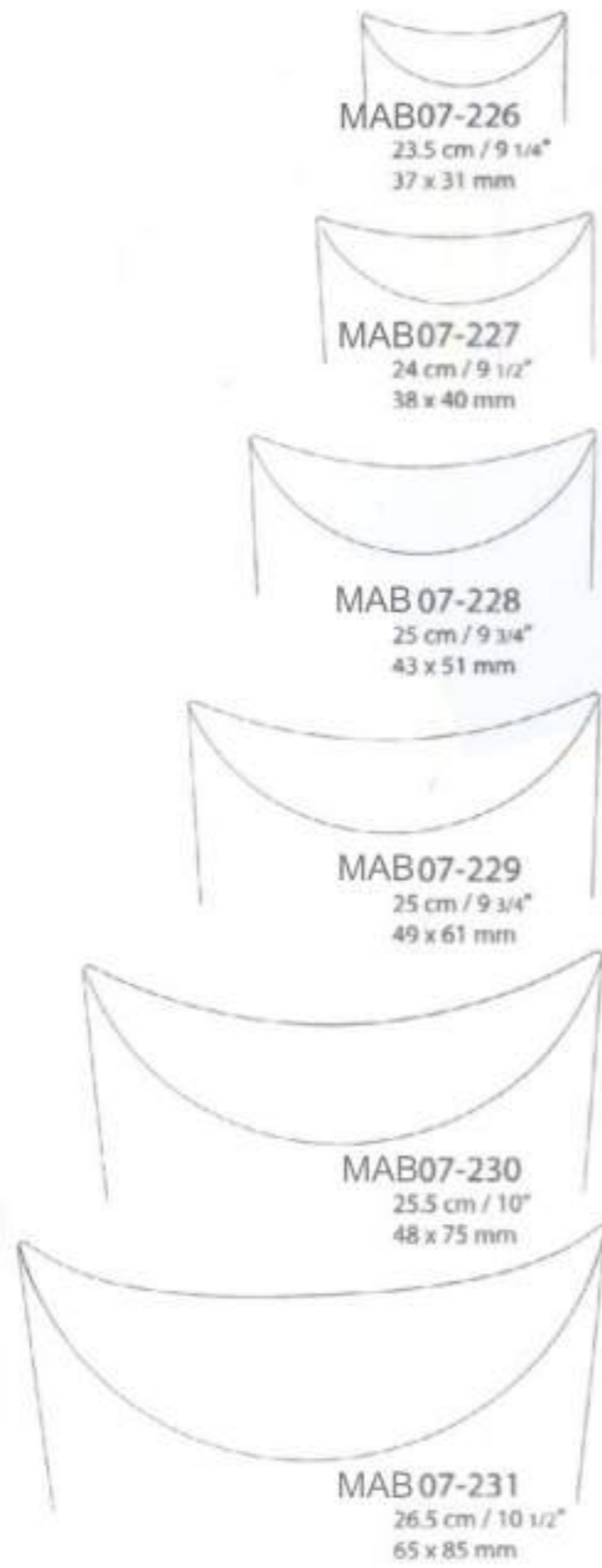

Allgemeines Instrumentarium . Instrumentation générale . Strumentario generale  
 Wundhaken  
 Retractors  
 Separadores  
 Ecarteurs  
 Divaricatori

Allgemeines Instrumentarium . General Instrumentation . Instrumental general  
 Wundhaken  
 Retractors  
 Separadores  
 Ecarteurs  
 Divaricatori





Allgemeines Instrumentarium . Instrumentation générale . Strumentario generale  
 Scapulahaken  
 Scapula Retractors  
 Separadores para escápula  
 Ecarteurs pour scapula  
 Divaricatori per scapola



Davidson  
 MAB07-243  
 19 cm / 7 1/2"  
 80 x 54 mm



Davidson  
 MAB07-244  
 18.5 cm / 7 1/4"  
 80 x 95 mm

Allgemeines Instrumentarium . Instrumentation générale . Strumentario generale  
 Wundhaken  
 Retractors  
 Separadores  
 Ecarteurs  
 Divaricatori

Allgemeines Instrumentarium . General Instrumentation . Instrumental general  
 Wundhaken  
 Retractors  
 Separadores  
 Ecarteurs  
 Divaricatori



MAB07-245  
 25.5 cm / 10"  
 127 x 38 mm

Sauerbruch



Brunner

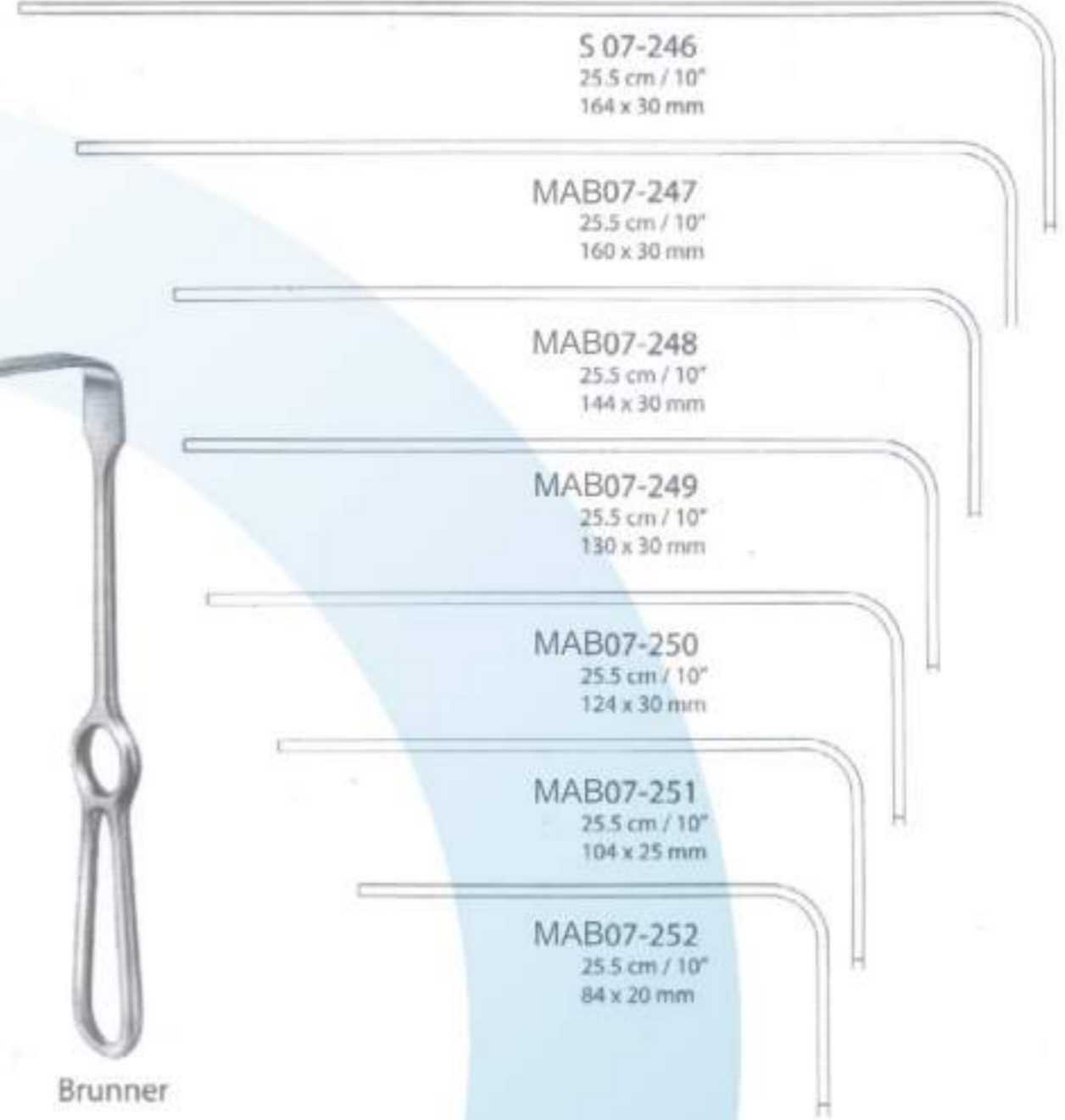

S 07-246  
 25.5 cm / 10"  
 164 x 30 mm

MAB07-247  
 25.5 cm / 10"  
 160 x 30 mm

MAB07-248  
 25.5 cm / 10"  
 144 x 30 mm

MAB07-249  
 25.5 cm / 10"  
 130 x 30 mm

MAB07-250  
 25.5 cm / 10"  
 124 x 30 mm

MAB07-251  
 25.5 cm / 10"  
 104 x 25 mm

MAB07-252  
 25.5 cm / 10"  
 84 x 20 mm

Allgemeines Instrumentarium . General Instrumentation . Instrumental general  
 Wundhaken  
 Retractors  
 Separadores  
 Ecarteurs  
 Divaricatori

Allgemeines Instrumentarium . Instrumentation générale . Strumentario generale  
 Wundhaken  
 Retractors  
 Separadores  
 Ecarteurs  
 Divaricatori

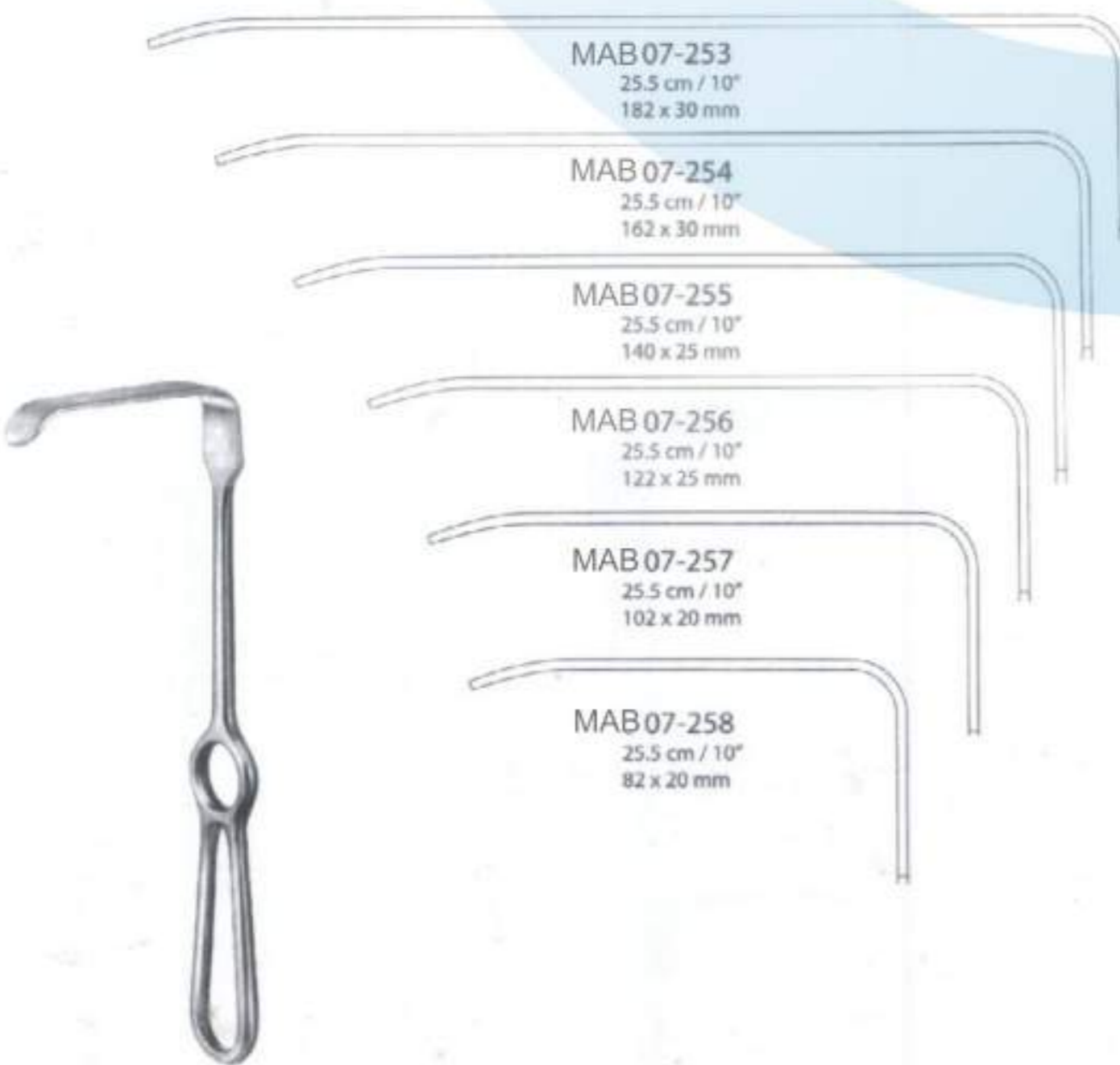

MAB07-253  
 25.5 cm / 10"  
 182 x 30 mm

MAB07-254  
 25.5 cm / 10"  
 162 x 30 mm

MAB07-255  
 25.5 cm / 10"  
 140 x 25 mm

MAB07-256  
 25.5 cm / 10"  
 122 x 25 mm

MAB07-257  
 25.5 cm / 10"  
 102 x 20 mm

MAB07-258  
 25.5 cm / 10"  
 82 x 20 mm

Brunner



Sauerbruch

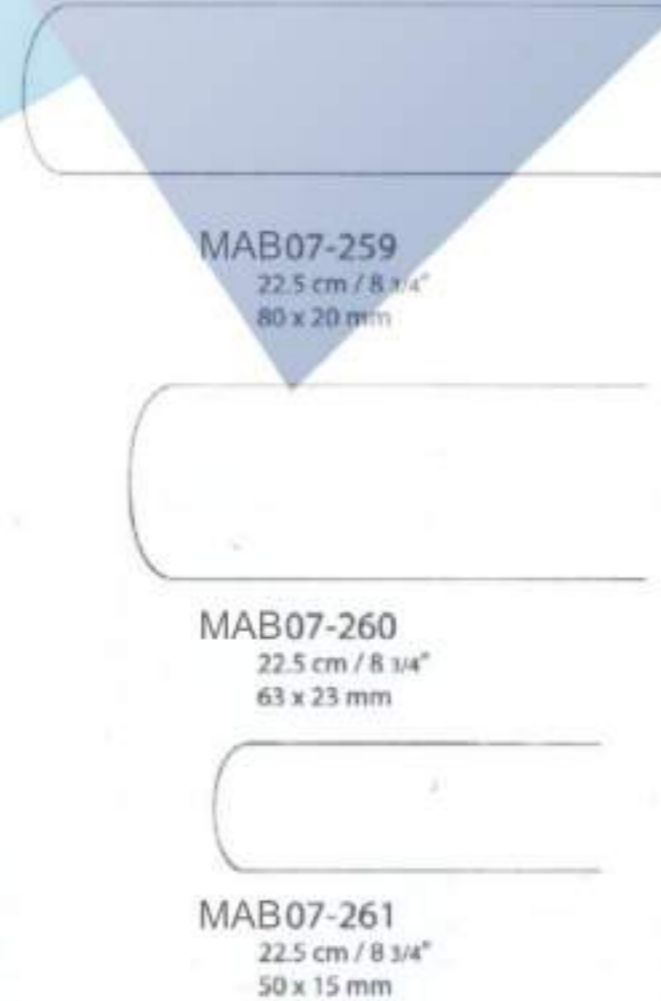

MAB07-259  
 22.5 cm / 8 1/4"  
 80 x 20 mm

MAB07-260  
 22.5 cm / 8 1/4"  
 63 x 23 mm

MAB07-261  
 22.5 cm / 8 1/4"  
 50 x 15 mm



Allgemeines Instrumentarium . General Instrumentation . Instrumental general  
**Aortahaken**  
**Aorta Retractors**  
**Separadores para aorta**  
**Ecarteurs pour aorta**  
**Divaricatori per aorta**

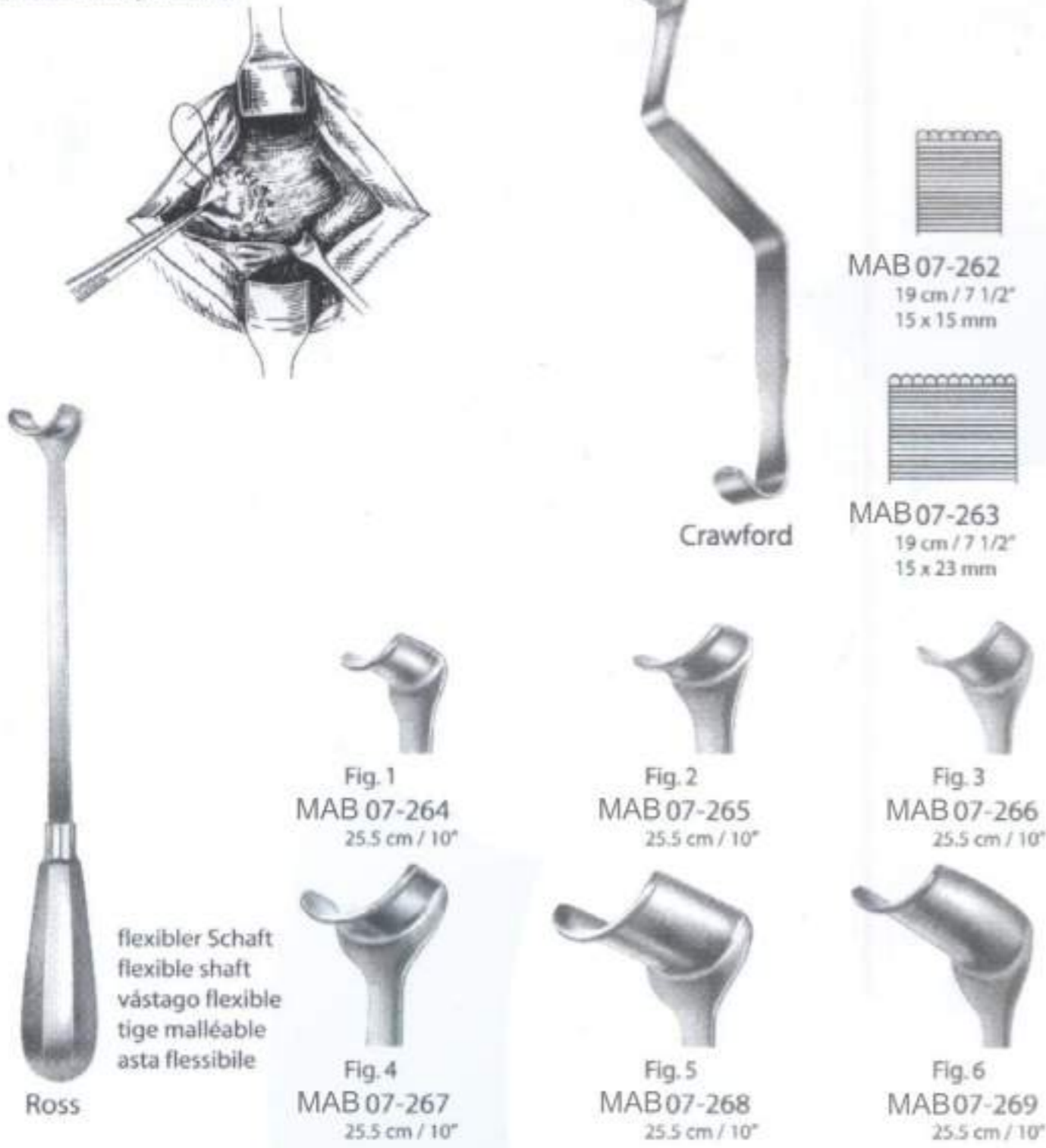

Allgemeines Instrumentarium . Instrumentation générale . Strumentario generale  
**Wundhaken**  
**Retractors**  
**Separadores**  
**Ecarteurs**  
**Divaricatori**



Allgemeines Instrumentarium . General Instrumentation . Instrumental general  
**Wundhaken**  
**Retractors**  
**Separadores**  
**Ecarteurs**  
**Divaricatori**

Allgemeines Instrumentarium . Instrumentation générale . Strumentario generale  
**Wundhaken**  
**Retractors**  
**Separadores**  
**Ecarteurs**  
**Divaricatori**

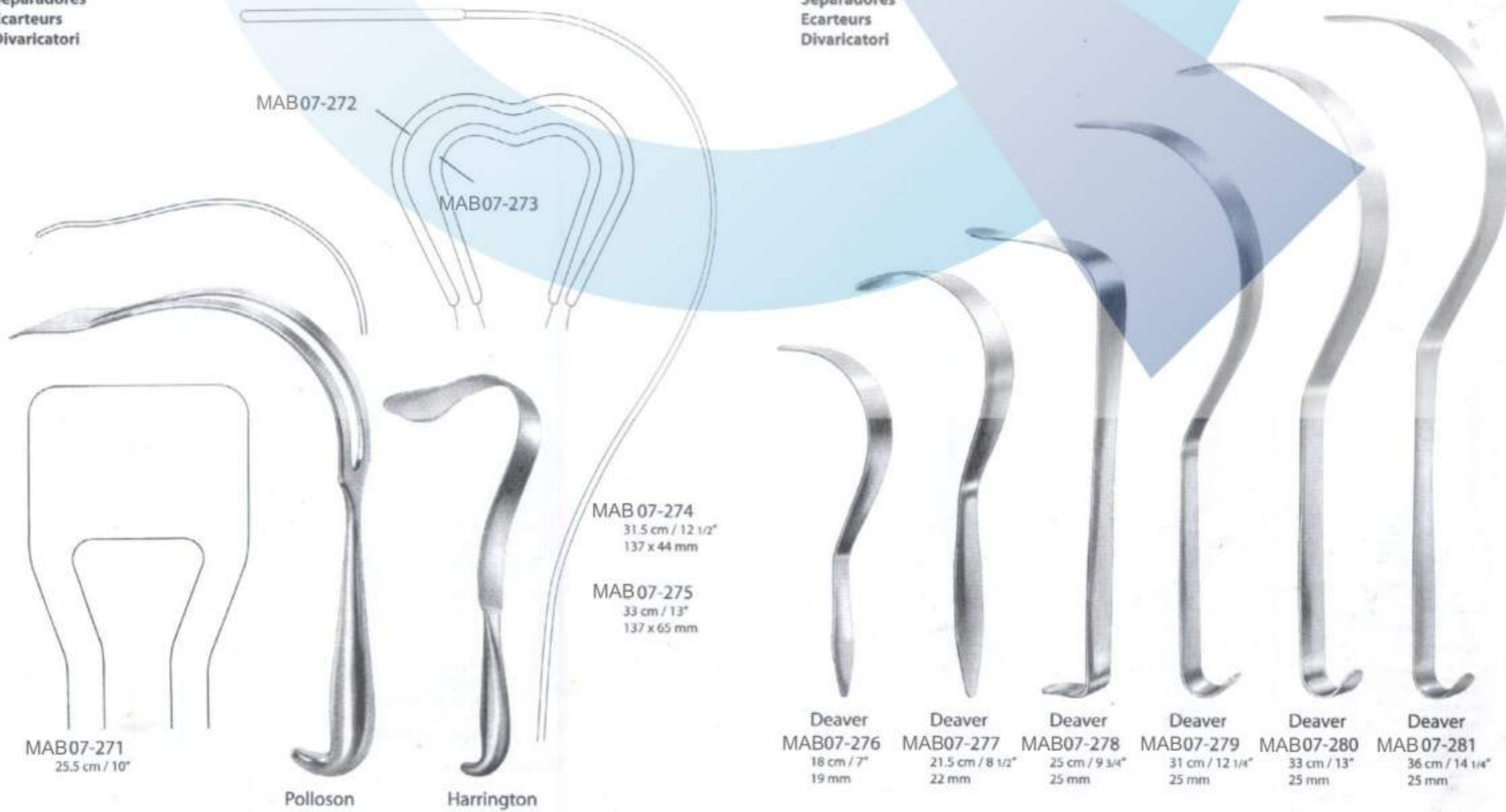



Allgemeines Instrumentarium . General Instrumentation . Instrumental general  
 Wundhaken  
 Retractors  
 Separadores  
 Ecarteurs  
 Divaricatori

Allgemeines Instrumentarium . Instrumentation générale . Strumentario generale  
 Wundhaken  
 Retractors  
 Separadores  
 Ecarteurs  
 Divaricatori

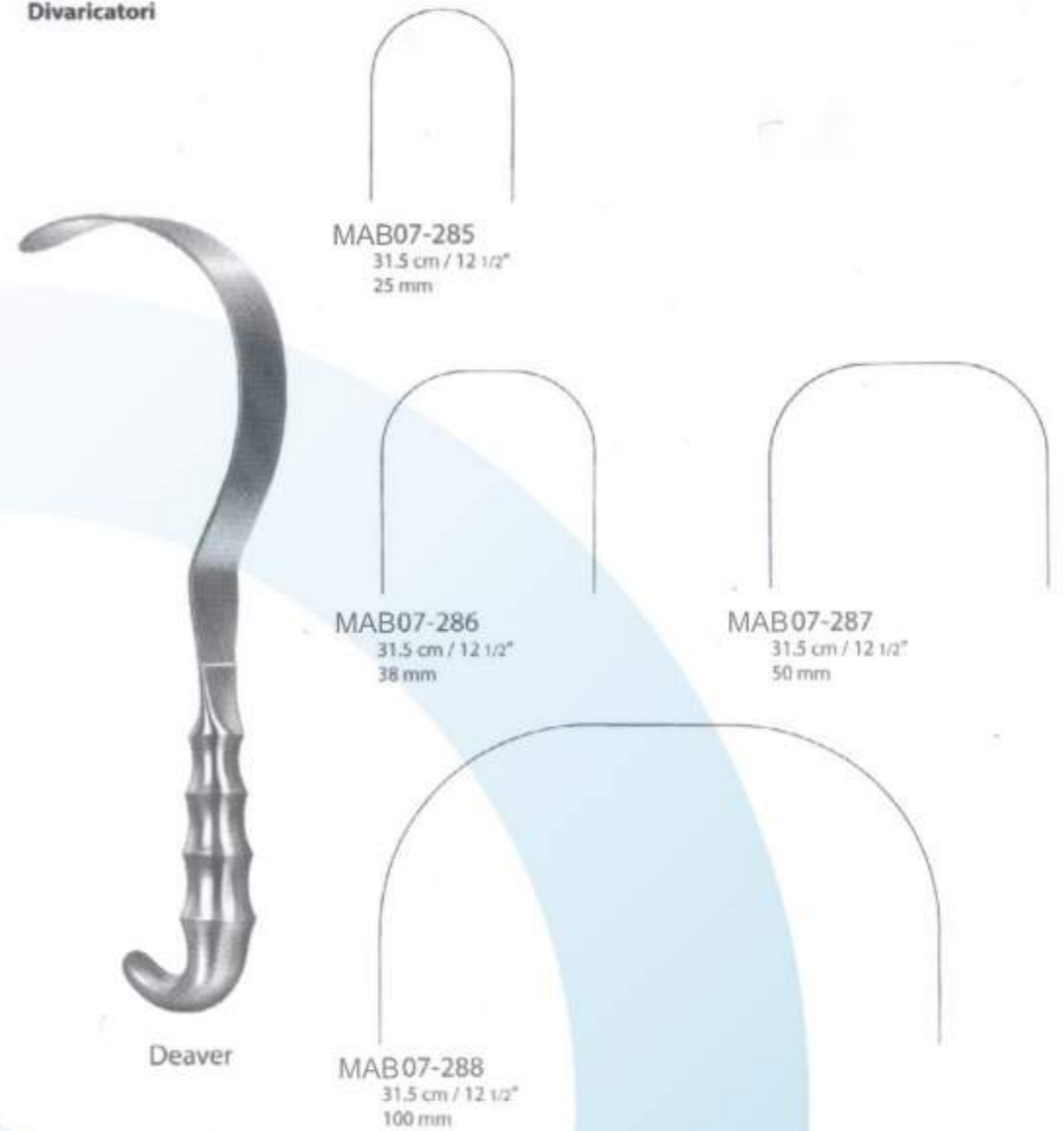

Allgemeines Instrumentarium . General Instrumentation . Instrumental general  
 Atriumhaken  
 Atrium Retractors  
 Separadores para atrio  
 Ecarteurs pour atrium  
 Divaricatori per atrio

Allgemeines Instrumentarium . Instrumentation générale . Strumentario generale  
 Wundhaken  
 Retractors  
 Separadores  
 Ecarteurs  
 Divaricatori

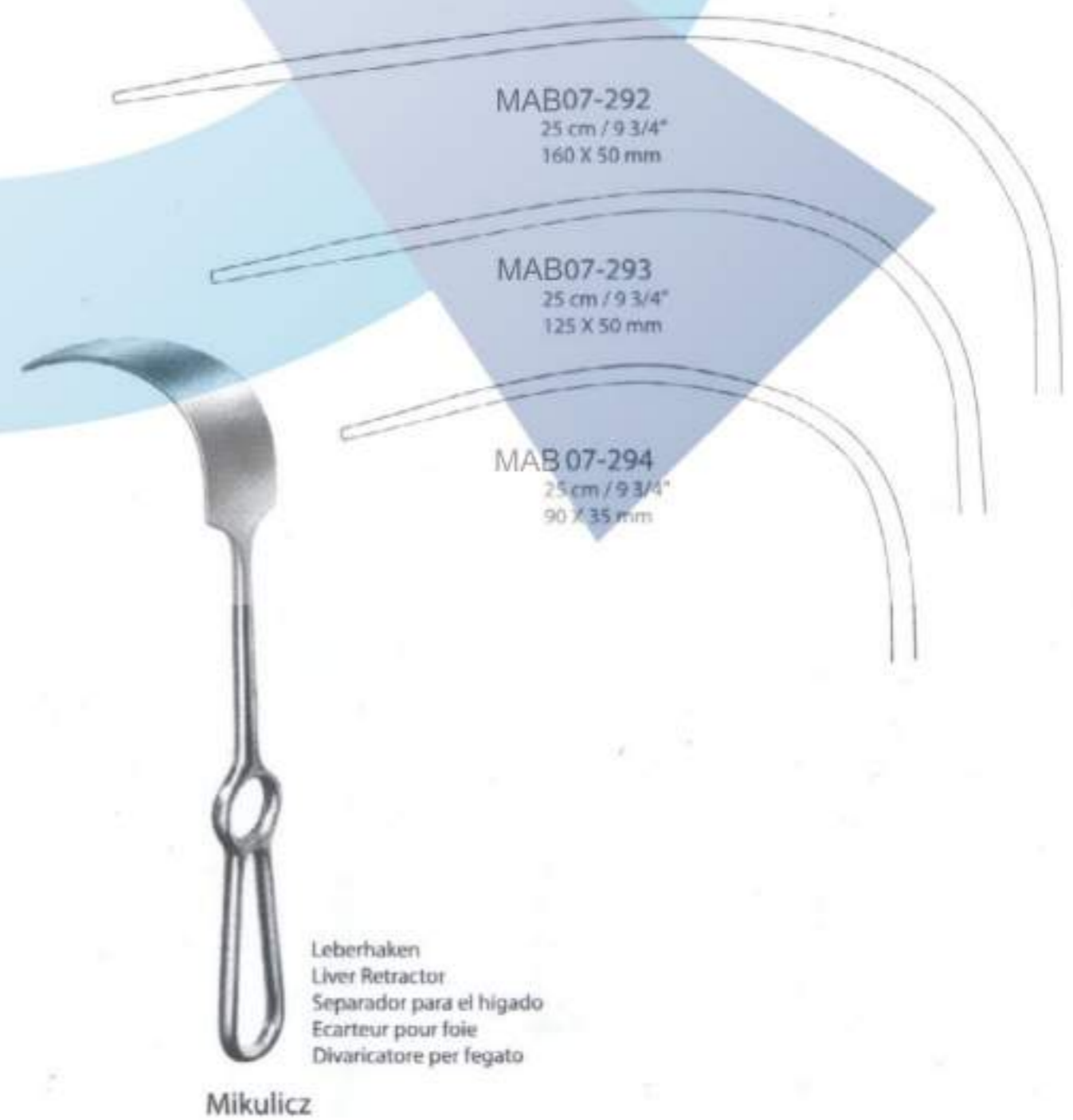



Allgemeines Instrumentarium . General Instrumentation . Instrumental general

**Wundhaken**  
Retractors  
Separadores  
Ecarteurs  
Divaricatori



MAB07-296  
27.5 cm / 10 3/4"  
205 X 35 mm



MAB07-297  
27.5 cm / 10 3/4"  
205 X 57 mm



MAB07-295  
26 cm / 10 1/4"  
90 X 55 mm

Mikulicz



Kelly



St. Marks

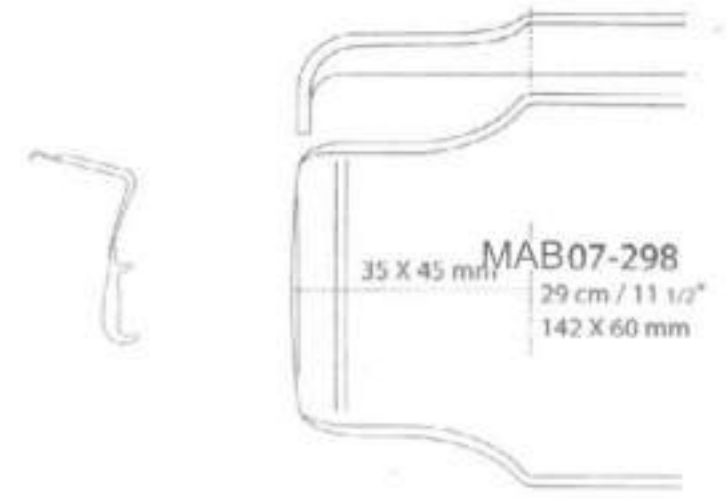

MAB07-298  
29 cm / 11 1/2"  
142 X 60 mm

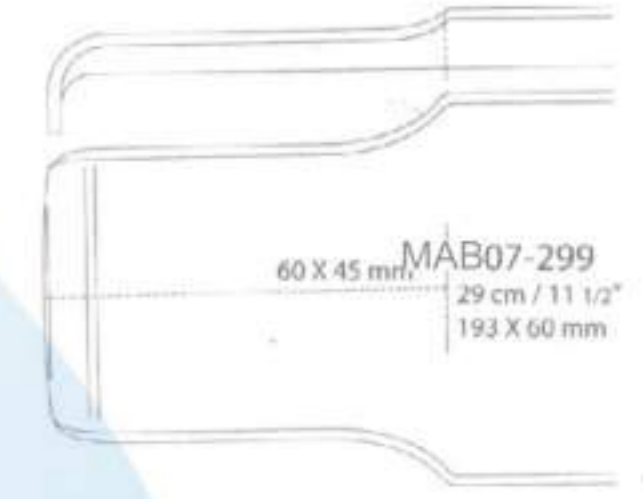

MAB07-299  
29 cm / 11 1/2"  
193 X 60 mm

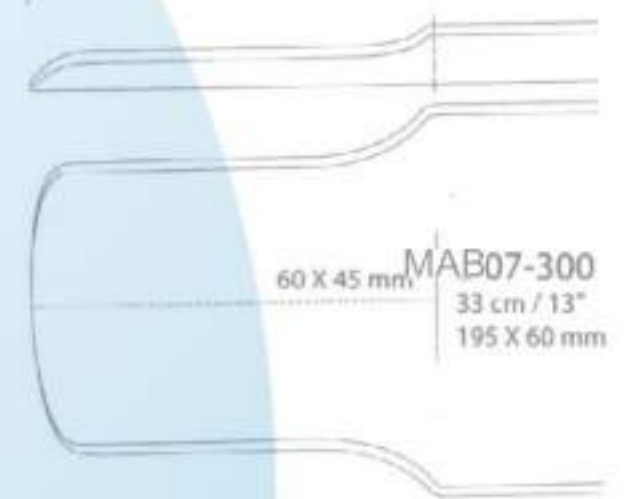

MAB07-300  
33 cm / 13"  
195 X 60 mm

Allgemeines Instrumentarium . General Instrumentation . Instrumental general

**Bauchspatel**  
Abdominal Spatulas  
Spatules  
Spatole



Kümmel  
MAB07-301  
31 cm / 12 1/4"



Kader



MAB07-302  
28 cm / 11"  
20 mm

MAB07-303  
28 cm / 11"  
30 mm

MAB07-304  
28 cm / 11"  
40 mm

Allgemeines Instrumentarium . Instrumentation générale . Strumentario generale

**Wundhaken**  
Retractors  
Separadores  
Ecarteurs  
Divaricatori



Roux



MAB07-305  
17 cm / 6 3/4"  
Fig. 1-3

Fig. 1  
MAB07-306  
14 cm / 5 1/2"

Fig. 2  
MAB07-307  
15 cm / 6"

Fig. 3  
MAB07-308  
17 cm / 6 3/4"



Allgemeines Instrumentarium . General Instrumentation . Instrumental general

**Wundhaken**  
Retractors  
Separadores  
Ecarteurs  
Divaricatori

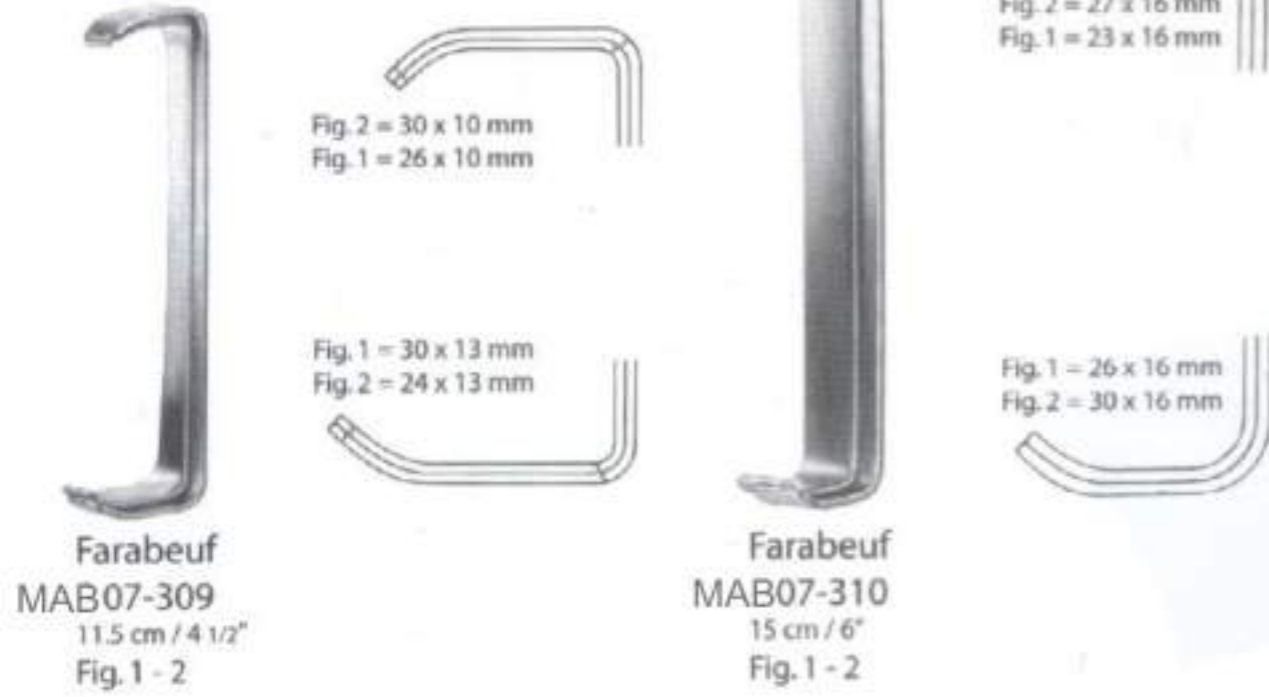

Allgemeines Instrumentarium . Instrumentation générale . Strumentario generale

**Wundhaken**  
Retractors  
Separadores  
Ecarteurs  
Divaricatori



Allgemeines Instrumentarium . General Instrumentation . Instrumental general

**Wundhaken**  
Retractors  
Separadores  
Ecarteurs  
Divaricatori



Allgemeines Instrumentarium . Instrumentation générale . Strumentario generale

**Wundspreizer**  
Wound Spreaders, self-retaining  
Separadores autoestáticos  
Ecarteurs autostatiques  
Divaricatori autostatici

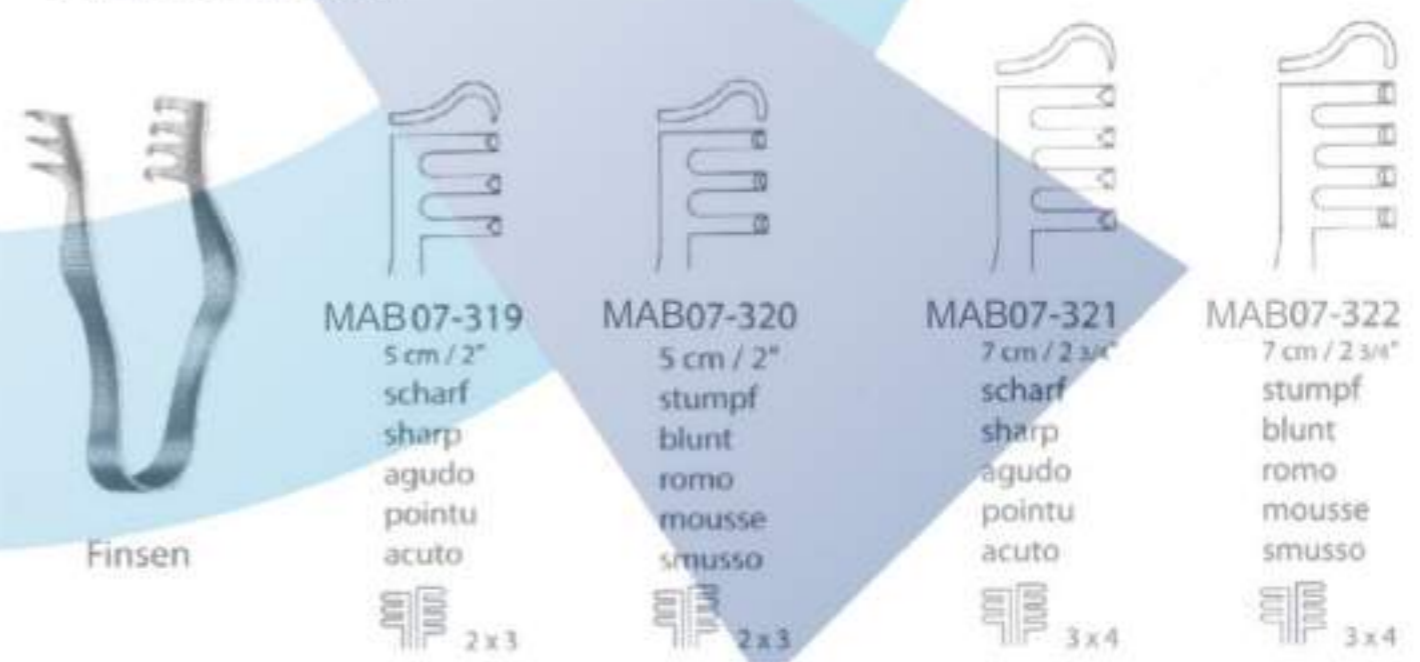



Allgemeines Instrumentarium . General Instrumentation . Instrumental general

**Wundspreizer**  
Wound Spreaders, self-retaining  
Separadores autoestáticos  
Ecarteurs autostatiques  
Divaricatori autostatici

**MAB07-326**  
3 cm / 1 1/4"  
Fettspreizer für Coronar-Eingriffe  
Fat Spreaders for coronary surgeries  
Separadores para grasa para Cirugia coronaria  
Ecarteurs pour graisse pour intervention coronaire  
Divaricatori per grasso Per interventi coronari

**MAB07-327**  
4 cm / 1 1/2"  
Fettspreizer für Coronar-Eingriffe  
Fat Spreaders for coronary surgeries  
Separadores para grasa para Cirugia coronaria  
Ecarteurs pour graisse pour intervention coronaire  
Divaricatori per grasso Per interventi coronari

**MAB07-328**  
5.5 cm / 2 1/4"  
Fettspreizer für Coronar-Eingriffe  
Fat Spreaders for coronary surgeries  
Separadores para grasa para Cirugia coronaria  
Ecarteurs pour graisse pour intervention coronaire  
Divaricatori per grasso Per interventi coronari

**Buckley MAB07-329**  
6 cm / 2 1/4"  
scharf sharp agudo pointu acuto

**Alm**  
mit Stellschraube with adjusting screw  
con tornillo de ajuste avec vis d'ajustage con vite di arresto

**MAB07-330**  
7 cm / 2 3/4"  
scharf sharp agudo pointu acuto

**MAB07-331**  
10 cm / 4"  
scharf sharp agudo pointu acuto

**MAB07-332**  
7 cm / 2 3/4"  
stumpf blunt romo mousse smusso

**MAB07-333**  
10 cm / 4"  
stumpf blunt romo mousse smusso

**MAB07-334**  
10 cm / 4"  
stumpf blunt romo mousse smusso

Allgemeines Instrumentarium . Instrumentation générale . Strumentario generale

**Wundspreizer**  
Wound Spreaders, self-retaining  
Separadores autoestáticos  
Ecarteurs autostatiques  
Divaricatori autostatici

**Jansen**  
mit Stellschraube with adjusting screw  
con tornillo de ajuste avec vis d'ajustage con vite di arresto

**MAB07-335**  
10 cm / 4"  
stumpf blunt romo mousse smusso

**Scalp-Contour**  
mit Sperre with ratchet  
con cremallera avec cremagliera

**MAB07-336**  
13.5 cm / 5 1/4"  
scharf sharp agudo pointu acuto

**MAB07-337**  
13.5 cm / 5 1/4"  
stumpf blunt romo mousse smusso

**Anderson-Adson MAB07-339**  
20 cm / 8"

**Weitlaner**  
20 cm / 8"

**MAB07-338**  
scharf sharp agudo pointu acuto

**MAB07-340**  
stumpf blunt romo mousse smusso

Allgemeines Instrumentarium . General Instrumentation . Instrumental general

**Wundspreizer**  
Wound Spreaders, self-retaining  
Separadores autoestáticos  
Ecarteurs autostatiques  
Divaricatori autostatici

**Adson**

**MAB07-341**  
26 cm / 10 1/4"  
scharf sharp agudo pointu acuto

**MAB07-342**  
26 cm / 10 1/4"  
stumpf blunt romo mousse smusso

**MAB07-343**  
29 cm / 11 1/2"  
scharf sharp agudo pointu acuto

**MAB07-344**  
29 cm / 11 1/2"  
stumpf blunt romo mousse smusso

Allgemeines Instrumentarium . Instrumentation générale . Strumentario generale

**Wundspreizer**  
Wound Spreaders, self-retaining  
Separadores autoestáticos  
Ecarteurs autostatiques  
Divaricatori autostatici

**Weitlaner**

**MAB07-345**  
11 cm / 4 1/4"  
scharf sharp agudo pointu acuto

**MAB07-346**  
11 cm / 4 1/4"  
stumpf blunt romo mousse smusso

**Weitlaner**

**MAB07-347**  
13.5 cm / 5 1/4"  
scharf sharp agudo pointu acuto

**MAB07-348**  
16 cm / 6 1/4"  
scharf sharp agudo pointu acuto

**MAB07-349**  
13.5 cm / 5 1/4"  
stumpf blunt romo mousse smusso

**MAB07-350**  
16 cm / 6 1/4"  
stumpf blunt romo mousse smusso

**Weitlaner-Wullstein**

**MAB07-351**  
13.5 cm / 5"  
scharf sharp agudo pointu acuto

**MAB07-352**  
13 cm / 5"  
stumpf blunt romo mousse smusso

**Mollison**

**MAB07-353**  
15.5 cm / 6"  
scharf sharp agudo pointu acuto



Allgemeines Instrumentarium . General Instrumentation . Instrumental general

**Wundspreizer**  
**Wound Spreaders, self-retaining**  
**Separadores autoestáticos**  
**Ecarteurs autostatiques**  
**Divaricatori autostatici**

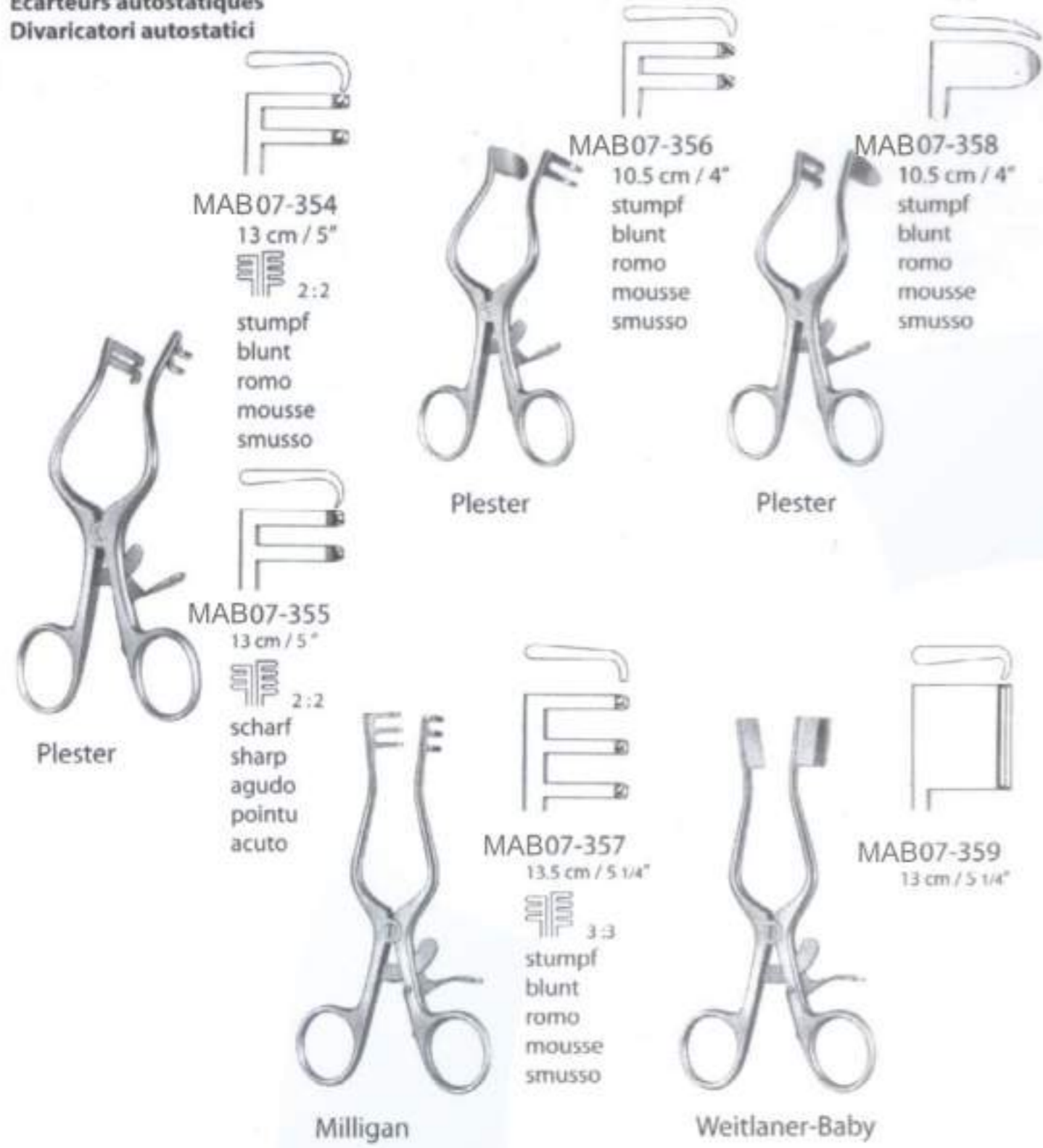

MAB07-354  
13 cm / 5"  
2:2  
stumpf  
blunt  
romo  
mousse  
smusso

MAB07-355  
13 cm / 5"  
2:2  
scharf  
sharp  
agudo  
pointu  
acuto

MAB07-356  
10.5 cm / 4"  
stumpf  
blunt  
romo  
mousse  
smusso

MAB07-358  
10.5 cm / 4"  
stumpf  
blunt  
romo  
mousse  
smusso

MAB07-357  
13.5 cm / 5 1/4"  
3:3  
stumpf  
blunt  
romo  
mousse  
smusso

MAB07-359  
13 cm / 5 1/4"

Plester

Plester

Plester

Milligan

Weitlaner-Baby

Allgemeines Instrumentarium . Instrumentation générale . Strumentario generale

**Wundspreizer**  
**Wound Spreaders, self-retaining**  
**Separadores autoestáticos**  
**Ecarteurs autostatiques**  
**Divaricatori autostatici**

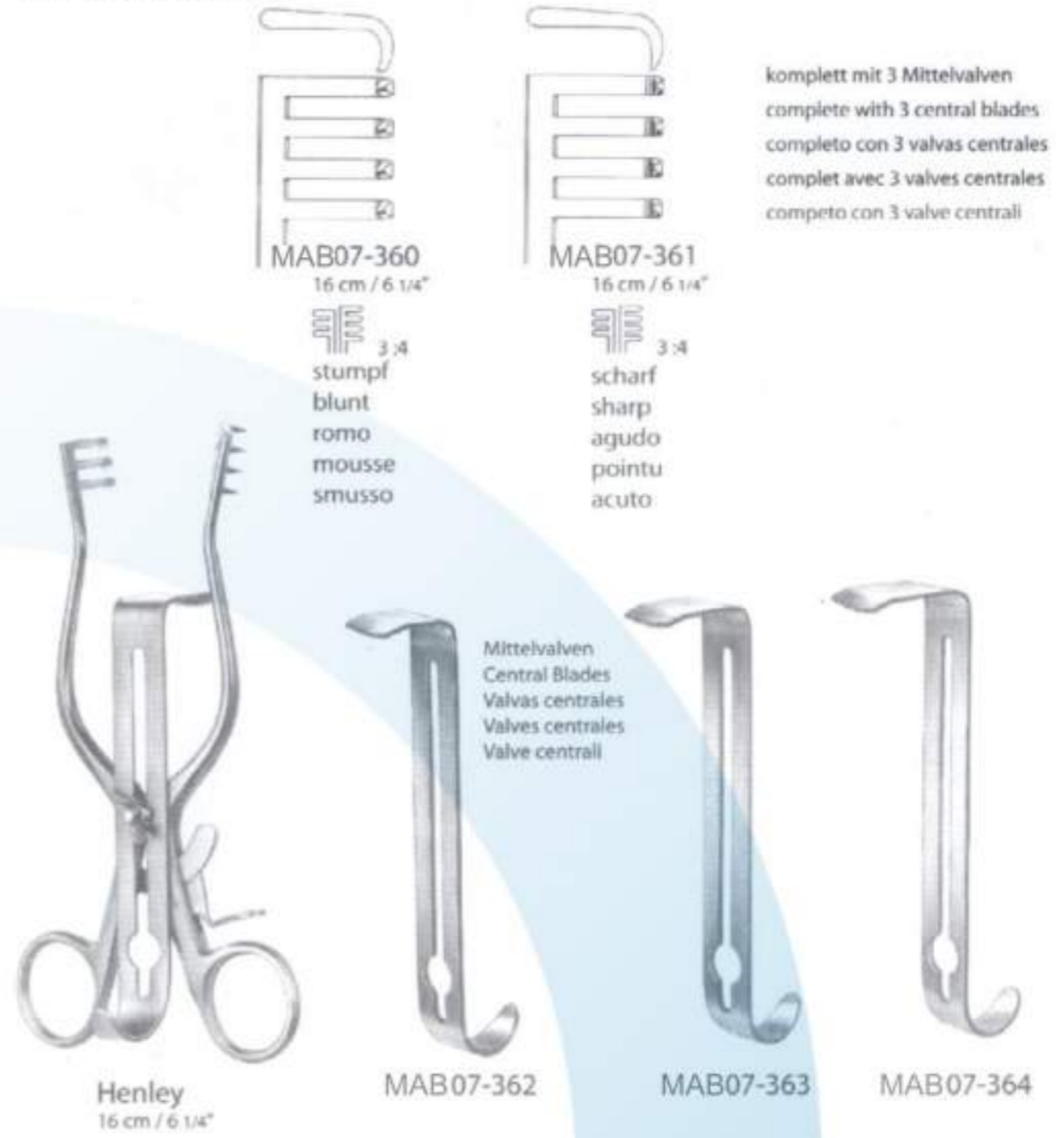

MAB07-360  
16 cm / 6 1/4"  
3:4  
stumpf  
blunt  
romo  
mousse  
smusso

MAB07-361  
16 cm / 6 1/4"  
3:4  
scharf  
sharp  
agudo  
pointu  
acuto

Mittelvalven  
Central Blades  
Valvas centrales  
Valves centrales  
Valve centrali

Henley  
16 cm / 6 1/4"

MAB07-362

MAB07-363

MAB07-364

komplett mit 3 Mittelvalven  
complete with 3 central blades  
completo con 3 valvas centrales  
complet avec 3 valves centrales  
completo con 3 valve centrali

Allgemeines Instrumentarium . General Instrumentation . Instrumental general

**Wundspreizer**  
**Wound Spreaders, self-retaining**  
**Separadores autoestáticos**  
**Ecarteurs autostatiques**  
**Divaricatori autostatici**

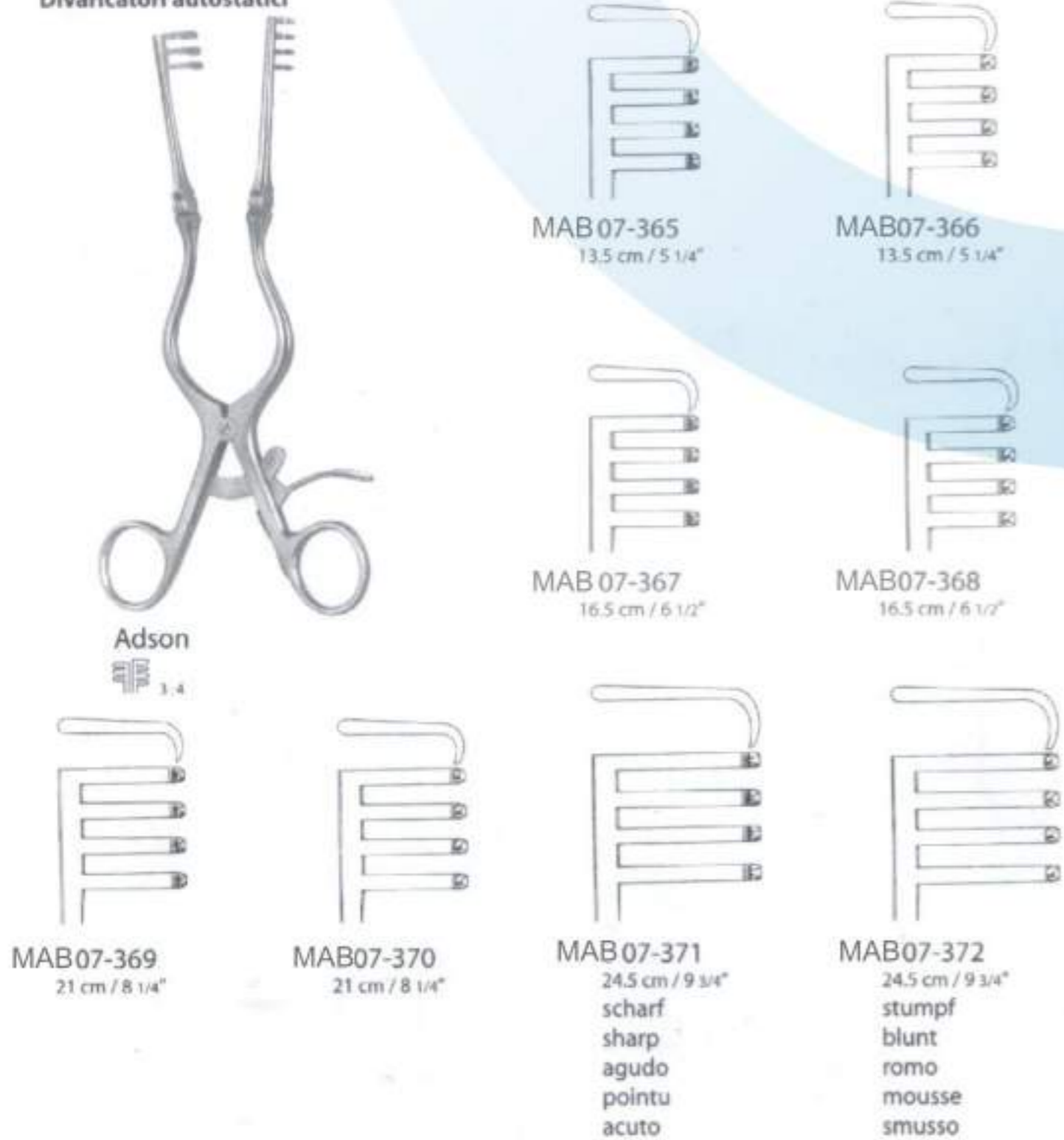

Adson  
3:4

MAB07-365  
13.5 cm / 5 1/4"

MAB07-366  
13.5 cm / 5 1/4"

MAB07-367  
16.5 cm / 6 1/2"

MAB07-368  
16.5 cm / 6 1/2"

MAB07-369  
21 cm / 8 1/4"

MAB07-370  
21 cm / 8 1/4"

MAB07-371  
24.5 cm / 9 3/4"  
scharf  
sharp  
agudo  
pointu  
acuto

MAB07-372  
24.5 cm / 9 3/4"  
stumpf  
blunt  
romo  
mousse  
smusso

Allgemeines Instrumentarium . Instrumentation générale . Strumentario generale

**Wundspreizer**  
**Wound Spreaders, self-retaining**  
**Separadores autoestáticos**  
**Ecarteurs autostatiques**  
**Divaricatori autostatici**

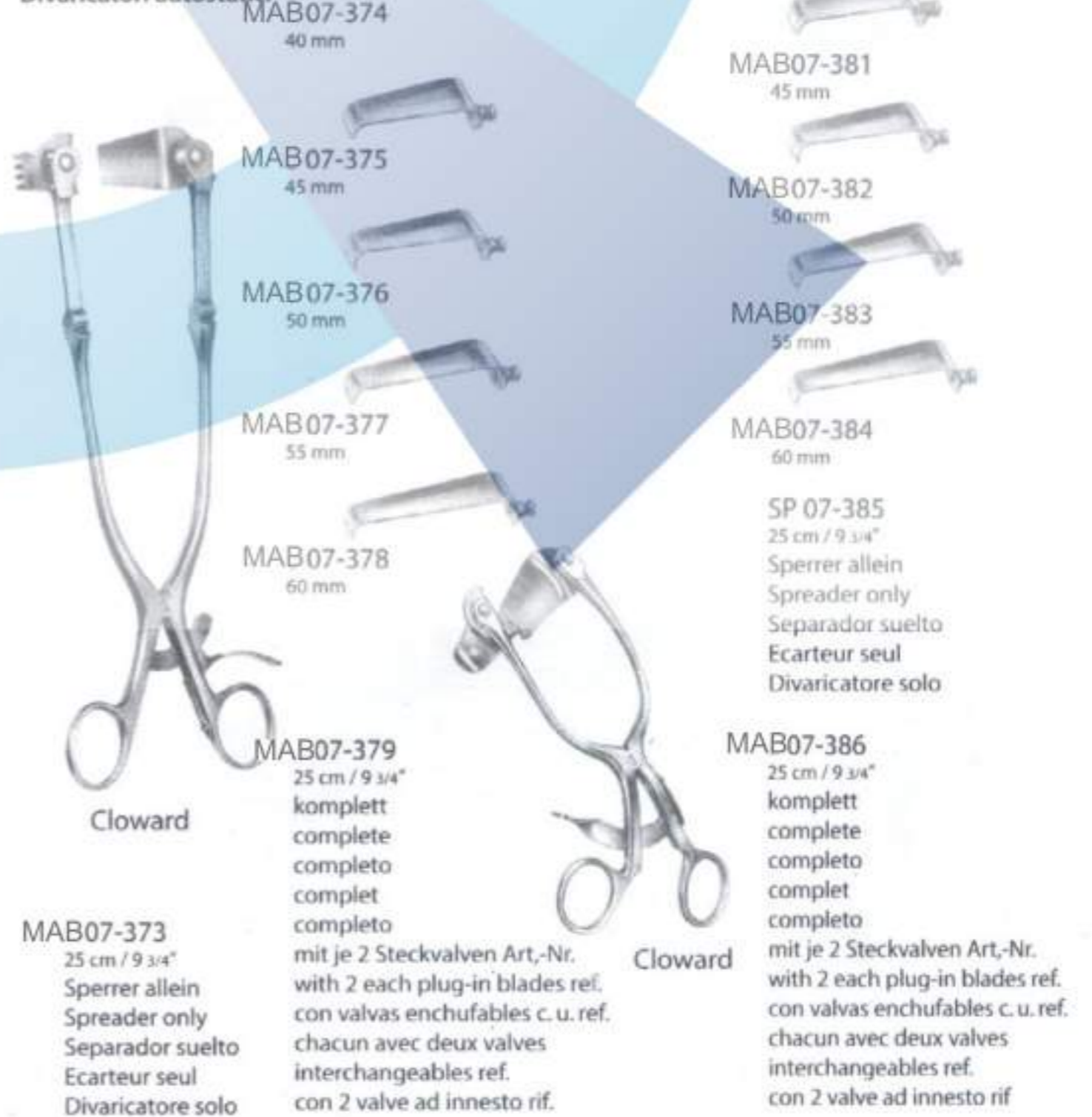

MAB07-373  
25 cm / 9 3/4"  
Sperrer allein  
Spreader only  
Separador suelto  
Ecarteur seul  
Divaricatore solo

MAB07-374  
40 mm

MAB07-375  
45 mm

MAB07-376  
50 mm

MAB07-377  
55 mm

MAB07-378  
60 mm

MAB07-379  
25 cm / 9 3/4"  
komplett  
complete  
completo  
complet  
completo  
mit je 2 Steckvalven Art.-Nr.  
with 2 each plug-in blades ref.  
con valvas enchufables c. u. ref.  
chacun avec deux valves  
interchangeables ref.  
con 2 valve ad innesto rif.

MAB07-380  
40 mm

MAB07-381  
45 mm

MAB07-382  
50 mm

MAB07-383  
55 mm

MAB07-384  
60 mm

SP 07-385  
25 cm / 9 3/4"  
Sperrer allein  
Spreader only  
Separador suelto  
Ecarteur seul  
Divaricatore solo

MAB07-386  
25 cm / 9 3/4"  
komplett  
complete  
completo  
complet  
completo  
mit je 2 Steckvalven Art.-Nr.  
with 2 each plug-in blades ref.  
con valvas enchufables c. u. ref.  
chacun avec deux valves  
interchangeables ref.  
con 2 valve ad innesto rif

Cloward

Cloward



Allgemeines Instrumentarium . General Instrumentation . Instrumental general

**Wundspreizer**  
**Wound Spreaders, self-retaining**  
**Separadores autoestáticos**  
**Ecarteurs autostatiques**  
**Divaricatori autostatici**



Allgemeines Instrumentarium . Instrumentation générale . Strumentario generale

**Wundspreizer**  
**Wound Spreaders, self-retaining**  
**Separadores autoestáticos**  
**Ecarteurs autostatiques**  
**Divaricatori autostatici**

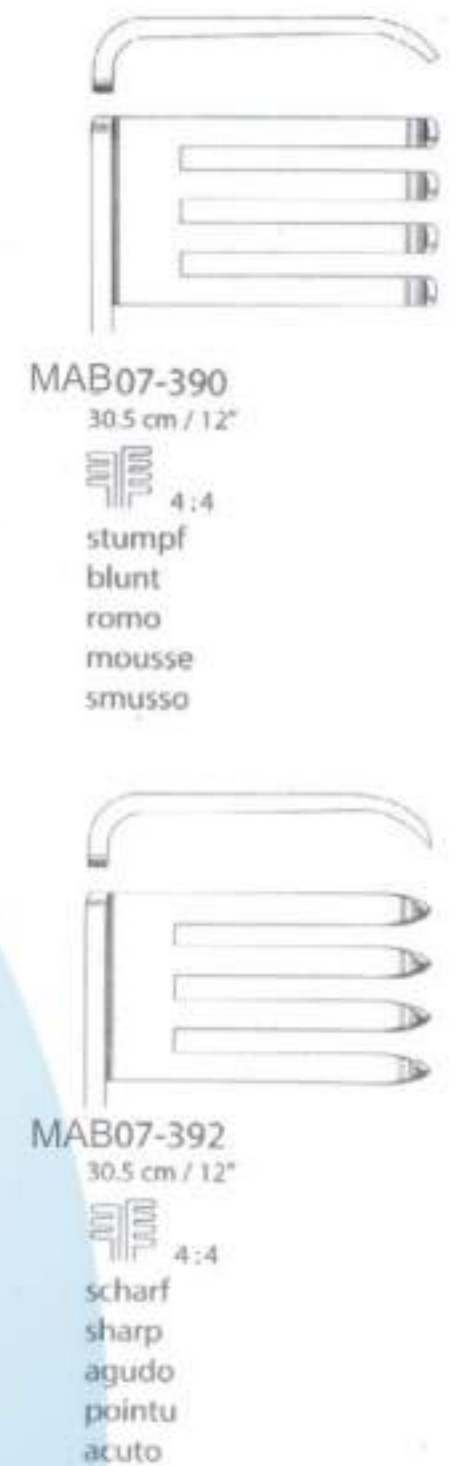

Allgemeines Instrumentarium . General Instrumentation . Instrumental general

**Wundspreizer**  
**Wound Spreaders, self-retaining**  
**Separadores autoestáticos**  
**Ecarteurs autostatiques**  
**Divaricatori autostatici**



Allgemeines Instrumentarium . Instrumentation générale . Strumentario generale

**Wundspreizer**  
**Wound Spreaders, self-retaining**  
**Separadores autoestáticos**  
**Ecarteurs autostatiques**  
**Divaricatori autostatici**





Allgemeines Instrumentarium . General Instrumentation . Instrumental general

**Wundspreizer**  
**Wound Spreaders, self-retaining**  
**Separadores autoestáticos**  
**Ecarteurs autostatiques**  
**Divaricatori autostatici**



**Vickers Low-Profile**  
**MAB07-396**  
 7.5 cm / 3"  
 komplett, mit Mittelvalve  
 complete, with central blade  
 completo, con valva central  
 complet, avec valve centrale  
 completo, con valva centrale

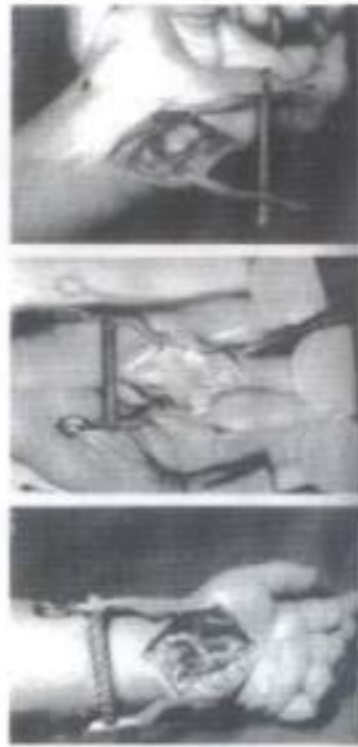

Allgemeines Instrumentarium . Instrumentation générale . Strumentario generale

**Wundspreizer**  
**Wound Spreaders, self-retaining**  
**Separadores autoestáticos**  
**Ecarteurs autostatiques**  
**Divaricatori autostatici**



**Vickers Low-Profile**  
**MAB 07-399**  
 9 cm / 3 1/2"  
 komplett, mit Mittelvalve  
 complete, with central blade  
 completo, con valva central  
 complet, avec valve centrale  
 completo, con valva centrale



**MAB07-397**  
 Mittelvalven  
 Central Blades  
 Valvas centrales  
 Valves centrales  
 Valve centrali  
 10 x 18 mm



**MAB07-398**  
 Mittelvalven  
 Central Blades  
 Valvas centrales  
 Valves centrales  
 Valve centrali  
 12 x 10 mm



**MAB 07-400**  
 Mittelvalven  
 Central Blades  
 Valvas centrales  
 Valves centrales  
 Valve centrali  
 10 x 18 mm



**MAB 07-401**  
 Mittelvalven  
 Central Blades  
 Valvas centrales  
 Valves centrales  
 Valve centrali  
 12 x 10 mm

Allgemeines Instrumentarium . General Instrumentation . Instrumental general

**Wundspreizer**  
**Wound Spreaders, self-retaining**  
**Separadores autoestáticos**  
**Ecarteurs autostatiques**  
**Divaricatori autostatici**



**Vickers Low-Profile**  
**MAB07-402**  
 7.5 cm / 3"  
 komplett, mit Mittelvalve  
 complete, with central blade  
 completo, con valva central  
 complet, avec valve centrale  
 completo, con valva centrale



Allgemeines Instrumentarium . Instrumentation générale . Strumentario generale

**Wundspreizer**  
**Wound Spreaders, self-retaining**  
**Separadores autoestáticos**  
**Ecarteurs autostatiques**  
**Divaricatori autostatici**



**Vickers**  
**MAB 07-405**  
 5 cm / 2"  
 stumpf, Ringmodell, für Daumen und Finger  
 blunt, ring model, for thumb and fingers  
 romo, forma de anillo, para pulgar y dedos  
 mousse, modèle anneau, pour pouce et doigts  
 smusso, modello anulare, per pollice e le dita



**MAB07-403**  
 Mittelvalven  
 Central Blades  
 Valvas centrales  
 Valves centrales  
 Valve centrali  
 10 x 18 mm



**MAB07-404**  
 Mittelvalven  
 Central Blades  
 Valvas centrales  
 Valves centrales  
 Valve centrali  
 12 x 10 mm



Allgemeines Instrumentarium . General Instrumentation . Instrumental general

**Wundspreizer**  
**Wound Spreaders, self-retaining**  
**Separadores autoestáticos**  
**Ecarteurs autostatiques**  
**Divaricatori autostatici**



**Joll**  
**MAB07-406**  
 15.5 cm / 6"  
 Thyreoid- und Vulva-Spreizer  
 Thyroid and Vaginal retractor  
 Separador para tiroides y vagina  
 Ecarteur pour thyroïde et vulva  
 Divaricatore per tiroide e vagina



**Gelpi**  
**MAB07-407**  
 13 cm / 5"

Allgemeines Instrumentarium . Instrumentation générale . Strumentario generale

**Bauchdeckenhalter**  
**Abdominal Retractors**  
**Separadores abdominales**  
**Ecarteurs abdominaux**  
**Divaricatori addominali**



**Collin, Baby**  
**MAB07-410**  
 20 cm / 8"  
 komplett, mit 2 paar Seitenvalven  
 (18 x 40 mm) und (27 x 40 mm)  
 complete, with 2 pairs of lateral blades  
 (18 x 40 mm) und (27 x 40 mm)  
 completo, con 2 pares de valvas laterales  
 (18 x 40 mm) y (27 x 40 mm)  
 complet, avec 2 paires de valves latérales  
 (18 x 40 mm) et (27 x 40 mm)  
 completo, con 2 paia di valve laterali  
 (18 x 40 mm) e (27 x 40 mm)



**Collin**  
**MAB07-411**  
 24 cm / 9 1/4"  
 komplett, mit 1 paar Seitenvalven  
 (38 x 60 mm)  
 complete, with 1 pair of lateral blades  
 (38 x 60 mm)  
 completo, con 1 par de valvas laterales  
 (38 x 60 mm)  
 complet, avec 1 paire de valves latérales  
 (38 x 60 mm)  
 completo, con 1 paio di valve laterali  
 (38 x 60 mm)



**MAB07-408**  
 18 cm / 7"

**Gelpi**



**MAB07-409**  
 18.5 cm / 7 1/4"

**Gelpi**

Allgemeines Instrumentarium . General Instrumentation . Instrumental general

**Bauchdeckenhalter**  
**Abdominal Retractors**  
**Separadores abdominales**  
**Ecarteurs abdominaux**  
**Divaricatori addominali**



**Collin**  
**MAB07-412**  
 22.5 cm / 9"  
 komplett, mit 1 paar Seitenvalven  
 (38 x 60 mm) und Mittelvalve 38 x 55 mm  
 complete, with 1 pair of lateral blades  
 (38 x 60 mm) and central blade 38 x 55 mm  
 completo, con 1 par de valvas laterales  
 (38 x 60 mm) y valva central 38 x 55 mm  
 complet, avec 1 paire de valves latérales  
 (38 x 60 mm) et valve centrale 38 x 55 mm  
 completo, con 1 paio di valve laterali  
 (38 x 60 mm) e valva centrale 38 x 55 mm

**Collin**  
**MAB07-414**  
 22.5 cm / 9"  
 komplett, mit 1 paar Seitenvalven  
 (45 x 80 mm) und Mittelvalve 50 x 75 mm  
 complete, with 1 pair of lateral blades  
 (45 x 80 mm) and central blade 50 x 75 mm  
 completo, con 1 par de valvas laterales  
 (45 x 80 mm) y valva central 50 x 75 mm  
 complet, avec 1 paire de valves latérales  
 (45 x 80 mm) et valve centrale 50 x 75 mm  
 completo, con 1 paio di valve laterali  
 (45 x 80 mm) e valva centrale 50 x 75 mm



**Collin**  
**MAB07-413**  
 31 cm / 12 1/4"  
 komplett, mit 1 paar Seitenvalven  
 (60 x 80 mm) und Mittelvalve 60 x 75 mm  
 complete, with 1 pair of lateral blades  
 (60 x 80 mm) and central blade 60 x 75 mm  
 completo, con 1 par de valvas laterales  
 (60 x 80 mm) y valva central 60 x 75 mm  
 complet, avec 1 paire de valves latérales  
 (60 x 80 mm) et valve centrale 60 x 75 mm  
 completo, con 1 paio di valve laterali  
 (60 x 80 mm) e valva centrale 60 x 75 mm

Allgemeines Instrumentarium . Instrumentation générale . Strumentario generale

**Bauchdeckenhalter**  
**Abdominal Retractor**  
**Separadores abdominal**  
**Ecarteurs abdominaux**  
**Divaricatori addominali**



**Ricard**  
**MAB07-415**  
 komplett, mit 1 paar Seitenvalven  
 und Mittelvalve  
 complete, with 1 pair of lateral blades  
 and central blade  
 completo, con 1 par de valvas laterales  
 y valva central  
 complet, avec 1 paire de valves latérales  
 et valve centrale  
 completo, con 1 paio di valve laterali  
 e valva centrale

**Ricard**  
**MAB07-416**  
 komplett, mit 1 paar Seitenvalven  
 und Mittelvalve  
 complete, with 1 pair of lateral blades  
 and central blade  
 completo, con 1 par de valvas laterales  
 y valva central  
 complet, avec 1 paire de valves latérales  
 et valve centrale  
 completo con 1 paio di valve laterali  
 e valva centrale

**MAB07-417**  
 Mittelvalve  
 Central Blade  
 Valva central  
 Valva central  
 Valva centrale  
 55 x 70 mm

**MAB07-418**  
 Mittelvalve  
 Central Blade  
 Valva central  
 Valva central  
 Valva centrale  
 55 x 70 mm



**MAB07-419**  
 Stück  
 piece  
 pieza  
 pièce  
 pezzo



**MAB07-420**  
 Stück  
 piece  
 pieza  
 pièce  
 pezzo

**Ricard**  
**MAB07-421**  
 Sperrer, allein  
 Spreader, only  
 Bastidor, suelto  
 Ecarteur, seule  
 Divaricatore, solo



Allgemeines Instrumentarium . General Instrumentation . Instrumental general

**Bauchdeckenhalter**  
**Abdominal Retractors**  
**Separadores abdominales**  
**Ecarteurs abdominaux**  
**Divaricatori addominali**



Kirschner  
**MAB07-468**  
 Rahmen  
 2 Haken und  
 2 Haken

frame  
 2 hooks and  
 2 hooks

bastidor  
 2 ganchos y  
 2 ganchos

cadre  
 2 valves et  
 2 valves

telaio  
 2 valve e  
 2 valve

Kirschner  
**MAB07-469**  
 Rahmen, allein  
 Farme, only  
 Cuadro, solo  
 Cadre, seul  
 Telaio, solo  
**240 x 240 mm**



Kirschner  
**MAB07-470**  
 40 x 55 mm



Kirschner  
**MAB07-471**  
 50 x 65 mm

Allgemeines Instrumentarium . Instrumentation générale . Strumentario generale

**Bauchdeckenhalter**  
**Abdominal Retractor**  
**Separador abdominal**  
**Ecarteur abdominal**  
**Divaricatori addominali**



255 mm Ø  
 rund, komplett mit 4 Valven  
 round, complete with 4 blades  
 redondo, completo con 4 valvas  
 rond, complet avec 4 valves  
 rotondo, completo con 4 valve

MAB07-472  
 Rahmen, allein  
 Frame, only  
 Cuadro, solo  
 Cadre, seul  
 Telaio, solo  
 255 mm Ø

Nylon

Kunststoff  
 röntgenfähig, schwarz

plastic  
 for X-ray work, black

plástico  
 justo para rayos X, negro

plastique  
 rayons X, noir

plastica  
 raggi X, nero



MAB07-473  
 Ersatzknopf  
 Spare Button  
 Botón de repuesto  
 Boutons de rechange  
 Bottone di ricambio



MAB07-474  
 Rahmenhaken  
 Blade  
 Valva  
 Valve  
 Valva  
**50 x 65 mm**



MAB07-475  
 Rahmenhaken  
 Blade  
 Valva  
 Valve  
 Valva  
**75 x 65 mm**

Allgemeines Instrumentarium . General Instrumentation . Instrumental general

**Laminektomiesperrer**  
**Laminectomy Retractors**  
**Separadores para laminectomía**  
**Ecarteurs pour laminectomie**  
**Divaricatori per laminectomia**



Scoville  
**MAB07-476**  
 Spreizweite  
 spreading  
 extensión  
 écartement  
 apertura  
**150 mm**



Scoville-Haverfield  
**MAB07-477**  
 Rahmen allein, mit Gelenk  
 frame only, with joint  
 bastidor suelto, con articulación  
 cadre seul, avec articulation  
 telaio solo, con articolazione  
 Spreizweite  
 spreading  
 extensión  
 écartement  
 apertura  
**150 mm**

Allgemeines Instrumentarium . Instrumentation générale . Strumentario generale

**Laminektomiesperrer**  
**Laminectomy Retractors**  
**Separadores para laminectomía**  
**Ecarteurs pour laminectomie**  
**Divaricatori per laminectomia**



Scoville  
**MAB07-478**  
 Hakenvalve, Stück  
 Hook, piece  
 Gancho, pieza  
 Valve à griffes, pièce  
 Uncino, pezzo

50 mm tief, stumpf  
 50 mm deep, blunt  
 50 mm de profundidad, romo  
 profondeur 50 mm, mousse  
 profondità 50 mm, smusso



Scoville  
**MAB07-479**  
 Hakenvalve, Stück  
 Hook, piece  
 Gancho, pieza  
 Valve à griffes, pièce  
 Uncino, pezzo

70 mm tief, stumpf  
 70 mm deep, blunt  
 70 mm de profundidad, romo  
 profondeur 70 mm, mousse  
 profondità 70 mm, smusso



Scoville  
**MAB07-480**  
 Hakenvalve, Stück  
 Hook, piece  
 Gancho, pieza  
 Valve à griffes, pièce  
 Uncino, pezzo

50 mm tief, spitz  
 50 mm deep, sharp  
 50 mm de profundidad, agudo  
 profondeur 50 mm, pointu  
 profondità 50 mm, acuto



Scoville  
**MAB07-481**  
 Hakenvalve, Stück  
 Hook, piece  
 Gancho, pieza  
 Valve à griffes, pièce  
 Uncino, pezzo

70 mm tief, spitz  
 70 mm deep, sharp  
 70 mm de profundidad, agudo  
 profondeur 70 mm, pointu  
 profondità 70 mm, acuto



Scoville  
 Blattvalven, Stück  
 Blades, piece  
 Valvas, pieza  
 Valves, pièce  
 Valve, pezzo

gezahnt  
 toothed  
 dentado  
 dentelé  
 dentato

MAB07-482 = 60 x 25 mm  
 MAB07-483 = 64 x 50 mm  
 MAB07-484 = 88 x 25 mm



Taylor  
 Hakenvalve, Stück  
 Hook, piece  
 Valva, pieza  
 Valve, pièce  
 Valvola, pezzo

spitz  
 sharp  
 agudo  
 pointu  
 acuto

MAB07-485 = 48 x 50 mm  
 MAB07-486 = 64 x 50 mm  
 MAB07-487 = 64 x 64 mm  
 MAB07-488 = 80 x 57 mm



Scoville  
 Hakenvalve, Stück  
 Hook, piece  
 Valva, pieza  
 Valve, pièce  
 Valvola, pezzo

spitz  
 sharp  
 agudo  
 pointu  
 acuto

MAB07-489 = 41 x 38 mm  
 MAB07-490 = 67 x 44 mm



Allgemeines Instrumentarium . General Instrumentation . Instrumental general

**Wundspreizer**  
**Wound Spreaders, self-retaining**  
**Separadores autoestáticos**  
**Ecarteurs autostatiques**  
**Divaricatori autostatici**



**Joll**  
**MAB 07-406**  
 15.5 cm / 6"  
 Thyroid- und Vulva-Spreizer  
 Thyroid and Vaginal retractor  
 Separador para tiroides y vagina  
 Ecarteur pour thyroïde et vulva  
 Divaricatore per tiroide e vagina



**Gelpi**  
**MAB 07-407**  
 13 cm / 5"

Allgemeines Instrumentarium . Instrumentation générale . Strumentario generale

**Bauchdeckenhalter**  
**Abdominal Retractors**  
**Separadores abdominales**  
**Ecarteurs abdominaux**  
**Divaricatori addominali**



**Collin, Baby**  
**MAB 07-410**  
 20 cm / 8"  
 komplett, mit 2 paar Seitenvalven  
 (18 x 40 mm) und (27 x 40 mm)  
 complete, with 2 pairs of lateral blades  
 (18 x 40 mm) und (27 x 40 mm)  
 completo, con 2 pares de valvas laterales  
 (18 x 40 mm) y (27 x 40 mm)  
 complet, avec 2 paires de valves latérales  
 (18 x 40 mm) et (27 x 40 mm)  
 completo, con 2 paia di valve laterali  
 (18 x 40 mm) e (27 x 40 mm)



**Collin**  
**MAB 07-411**  
 24 cm / 9 1/4"  
 komplett, mit 1 paar Seitenvalven  
 (38 x 60 mm)  
 complete, with 1 pair of lateral blades  
 (38 x 60 mm)  
 completo, con 1 par de valvas laterales  
 (38 x 60 mm)  
 complet, avec 1 paire de valves latérales  
 (38 x 60 mm)  
 completo, con 1 paio di valve laterali  
 (38 x 60 mm)



**MAB 07-408**  
 18 cm / 7"

Gelpi



**MAB 07-409**  
 18.5 cm / 7 1/4"

Gelpi

Allgemeines Instrumentarium . General Instrumentation . Instrumental general

**Bauchdeckenhalter**  
**Abdominal Retractors**  
**Separadores abdominales**  
**Ecarteurs abdominaux**  
**Divaricatori addominali**



**Collin**  
**MAB 07-412**  
 22.5 cm / 9"  
 komplett, mit 1 paar Seitenvalven  
 (38 x 60 mm) und Mittelvalve 38 x 55 mm  
 complete, with 1 pair of lateral blades  
 (38 x 60 mm) and central blade 38 x 55 mm  
 completo, con 1 par de valvas laterales  
 (38 x 60 mm) y valva central 38 x 55 mm  
 complet, avec 1 paire de valves latérales  
 (38 x 60 mm) et valve centrale 38 x 55 mm  
 completo, con 1 paio di valve laterali  
 (38 x 60 mm) e valva centrale 38 x 55 mm

**Collin**  
**MAB 07-414**  
 22.5 cm / 9"  
 komplett, mit 1 paar Seitenvalven  
 (45 x 80 mm) und Mittelvalve 50 x 75 mm  
 complete, with 1 pair of lateral blades  
 (45 x 80 mm) and central blade 50 x 75 mm  
 completo, con 1 par de valvas laterales  
 (45 x 80 mm) y valva central 50 x 75 mm  
 complet, avec 1 paire de valves latérales  
 (45 x 80 mm) et valve centrale 50 x 75 mm  
 completo, con 1 paio di valve laterali  
 (45 x 80 mm) e valva centrale 50 x 75 mm



**Collin**  
**MAB 07-413**  
 31 cm / 12 1/4"  
 komplett, mit 1 paar Seitenvalven  
 (60 x 80 mm) und Mittelvalve 60 x 75 mm  
 complete, with 1 pair of lateral blades  
 (60 x 80 mm) and central blade 60 x 75 mm  
 completo, con 1 par de valvas laterales  
 (60 x 80 mm) y valva central 60 x 75 mm  
 complet, avec 1 paire de valves latérales  
 (60 x 80 mm) et valve centrale 60 x 75 mm  
 completo, con 1 paio di valve laterali  
 (60 x 80 mm) e valva centrale 60 x 75 mm

Allgemeines Instrumentarium . Instrumentation générale . Strumentario generale

**Bauchdeckenhalter**  
**Abdominal Retractor**  
**Separadores abdominal**  
**Ecarteurs abdominaux**  
**Divaricatori addominali**



**Ricard**  
**MAB 07-415**  
 komplett, mit 1 paar Seitenvalven  
 und Mittelvalve  
 complete, with 1 pair of lateral blades  
 and central blade  
 completo, con 1 par de valvas laterales  
 y valva central  
 complet, avec 1 paire de valves latérales  
 et valve centrale  
 completo, con 1 paio di valve laterali  
 e valva centrale

**Ricard**  
**MAB 07-416**  
 komplett, mit 1 paar Seitenvalven  
 und Mittelvalve  
 complete, with 1 pair of lateral blades  
 and central blade  
 completo, con 1 par de valvas laterales  
 y valva central  
 complet, avec 1 paire de valves latérales  
 et valve centrale  
 completo, con 1 paio di valve laterali  
 e valva centrale

**MAB 07-417**  
 Mittelvalve  
 Central Blade  
 Valva central  
 Valva central  
 Valva centrale  
 55 x 70 mm

**MAB 07-418**  
 Mittelvalve  
 Central Blade  
 Valva central  
 Valva central  
 Valva centrale  
 55 x 70 mm



**MAB 07-419**  
 Stück  
 piece  
 pieza  
 pièce  
 pezzo



**MAB 07-420**  
 Stück  
 piece  
 pieza  
 pièce  
 pezzo

**Ricard**  
**MAB 07-421**  
 Sperrer, allein  
 Spreader, only  
 Bastidor, suelto  
 Ecarteur, seule  
 Divaricatore, solo



**Allgemeines Instrumentarium . General Instrumentation . Instrumental general**  
**Bauchdeckenhalter**  
**Abdominal Retractors**  
**Separadores abdominales**  
**Ecarteurs abdominaux**  
**Divaricatori addominali**



**Kirschner**  
**MAB07-468**  
 Rahmen  
 2 Haken und  
 2 Haken

frame  
 2 hooks and  
 2 hooks

bastidor  
 2 ganchos y  
 2 ganchos

cadre  
 2 valves et  
 2 valves

telaio  
 2 valve e  
 2 valve

**Kirschner**  
**MAB07-469**  
 Rahmen, allein  
 Frame, only  
 Cuadro, solo  
 Cadre, seul  
 Telaio, solo  
**240 x 240 mm**



**Kirschner**  
**MAB07-470**  
 40 x 55 mm



**Kirschner**  
**MAB07-471**  
 50 x 65 mm

**Allgemeines Instrumentarium . Instrumentation générale . Strumentario generale**  
**Bauchdeckenhalter**  
**Abdominal Retractor**  
**Separador abdominal**  
**Ecarteur abdominal**  
**Divaricatori addominali**



255 mm Ø  
 rund, komplett mit 4 Valven  
 round, complete with 4 blades  
 redondo, completo con 4 valvas  
 rond, complet avec 4 valves  
 rotondo, completo con 4 valve

**MAB07-472**  
 Rahmen, allein  
 Frame, only  
 Cuadro, solo  
 Cadre, seul  
 Telaio, solo  
 255 mm Ø

**Nylon**

Kunststoff  
 röntgenfähig, schwarz

plastic  
 for X-ray work, black

plástico  
 justo para rayos X, negro

plastique  
 rayons X, noir

plastica  
 raggi X, nero



**MAB07-473**  
 Ersatzknopf  
 Spare Button  
 Botón de repuesto  
 Boutons de rechange  
 Bottone di ricambio



**MAB07-474**  
 Rahmenhaken  
 Blade  
 Valva  
 Valve  
 Valva  
**50 x 65 mm**



**MAB07-475**  
 Rahmenhaken  
 Blade  
 Valva  
 Valve  
 Valva  
**75 x 65 mm**

**Allgemeines Instrumentarium . General Instrumentation . Instrumental general**  
**Laminektomiesperrer**  
**Laminectomy Retractors**  
**Separadores para laminectomía**  
**Ecarteurs pour laminectomie**  
**Divaricatori per laminectomia**



**Scoville**  
**MAB07-476**  
 Spreizweite  
 spreading  
 extensión  
 écartement  
 apertura  
**150 mm**



**Scoville-Haverfield**  
**MAB07-477**  
 Rahmen allein, mit Gelenk  
 frame only, with joint  
 bastidor suelto, con articulación  
 cadre seul, avec articulation  
 telaio solo, con articolazione  
 Spreizweite  
 spreading  
 extensión  
 écartement  
 apertura  
**150 mm**

**Allgemeines Instrumentarium . Instrumentation générale . Strumentario generale**  
**Laminektomiesperrer**  
**Laminectomy Retractors**  
**Separadores para laminectomía**  
**Ecarteurs pour laminectomie**  
**Divaricatori per laminectomia**



**Scoville**  
**MAB07-478**  
 Hakenvalve, Stück  
 Hook, piece  
 Gancho, pieza  
 Valve à griffes, pièce  
 Uncino, pezzo

50 mm tief, stumpf  
 50 mm deep, blunt  
 50 mm de profundidad, roma  
 profondeur 50 mm, mousse  
 profondità 50 mm, smusso



**Scoville**  
**MAB07-479**  
 Hakenvalve, Stück  
 Hook, piece  
 Gancho, pieza  
 Valve à griffes, pièce  
 Uncino, pezzo

70 mm tief, stumpf  
 70 mm deep, blunt  
 70 mm de profundidad, roma  
 profondeur 70 mm, mousse  
 profondità 70 mm, smusso



**Scoville**  
**MAB07-480**  
 Hakenvalve, Stück  
 Hook, piece  
 Gancho, pieza  
 Valve à griffes, pièce  
 Uncino, pezzo

50 mm tief, spitz  
 50 mm deep, sharp  
 50 mm de profundidad, agudo  
 profondeur 50 mm, pointu  
 profondità 50 mm, acuto



**Scoville**  
**MAB07-481**  
 Hakenvalve, Stück  
 Hook, piece  
 Gancho, pieza  
 Valve à griffes, pièce  
 Uncino, pezzo

70 mm tief, spitz  
 70 mm deep, sharp  
 70 mm de profundidad, agudo  
 profondeur 70 mm, pointu  
 profondità 70 mm, acuto



**Scoville**  
 Blattvalven, Stück  
 Blades, piece  
 Valvas, pieza  
 Valves, pièce  
 Valve, pezzo

gezahnt  
 toothed  
 dentado  
 dentelé  
 dentato

MAB07-482 = 60 x 25 mm  
 MAB07-483 = 64 x 50 mm  
 MAB07-484 = 88 x 25 mm



**Taylor**  
 Hakenvalve, Stück  
 Hook, piece  
 Valva, pieza  
 Valve, pièce  
 Valvola, pezzo

spitz  
 sharp  
 agudo  
 pointu  
 acuto

MAB07-485 = 48 x 50 mm  
 MAB07-486 = 64 x 50 mm  
 MAB07-487 = 64 x 64 mm  
 MAB07-488 = 80 x 57 mm



**Scoville**  
 Hakenvalve, Stück  
 Hook, piece  
 Valva, pieza  
 Valve, pièce  
 Valvola, pezzo

spitz  
 sharp  
 agudo  
 pointu  
 acuto

MAB07-489 = 41 x 38 mm  
 MAB07-490 = 67 x 44 mm



Allgemeines Instrumentarium . General Instrumentation . Instrumental general

Bauchspatel  
Abdominal Spatulas  
Espátulas abdominales  
Spatules abdominales  
Spatole addominali

## MAB 08

Knopfsonden  
Probes  
Sondas abotonadas  
Sondas boutonnees  
Sonde a bottone



konische Form  
tapered  
forma cónica  
forme conique  
forma conica



biegsam, sehr weich  
malleable, very soft  
maleable, muy blando  
malléable, très souple  
malleabili, molto dolci

**Haberer**

**Martin**

MAB 07-491	33 cm / 13"	30 mm	MAB07-494	20 cm / 8"	17 - 25 mm	MAB07-497	20 cm / 8"	6.5 mm
MAB 07-492	33 cm / 13"	40 mm	MAB07-495	28 cm / 11"	25 - 30 mm	MAB07-598	20 cm / 8"	9.5 mm
MAB 07-493	33 cm / 13"	50 mm	MAB07-496	30 cm / 11 3/4"	37 - 45 mm	MAB07-599	20 cm / 8"	13 mm
						MAB07-600	20 cm / 8"	16 mm
						MAB07-601	20 cm / 8"	19 mm
						MAB07-602	20 cm / 8"	25 mm

Allgemeines Instrumentarium . General Instrumentation . Instrumental general

Knopfsonden  
Probes  
Sondas abotonadas  
Sondes boutonnees  
Sonde a bottone

Allgemeines Instrumentarium . Instrumentation générale . Strumentrio generale

Hohlsonden, Fistel­sonden  
Grooved Directors, Fistula Probes  
Sondas acanaladas, Sondas para fistula  
Sondes cannelées, Sondes pour fistule  
Sonde cannellata, Sonde per fistole

2 mm Ø

MAB08-001	= 11.5 cm / 4 1/2"
MAB08-002	= 13 cm / 5"
MAB08-003	= 14.5 cm / 5 3/4"
MAB08-004	= 16 cm / 6 1/4"
MAB08-005	= 18 cm / 7"
MAB08-006	= 20 cm / 8"
MAB08-007	= 25 cm / 9 3/4"
MAB08-008	= 30 cm / 11 3/4"

1 mm Ø

MAB08-009	= 11.5 cm / 4 1/2"
MAB08-010	= 13 cm / 5"
MAB08-011	= 14.5 cm / 5 3/4"
MAB08-012	= 16 cm / 6 1/4"
MAB08-013	= 18 cm / 7"
MAB08-014	= 20 cm / 8"

1.5 mm Ø

MAB 08-015	= 13 cm / 5"
MAB08-016	= 14.5 cm / 5 3/4"
MAB08-017	= 16 cm / 6 1/4"
MAB08-018	= 18 cm / 7"
MAB08-019	= 20 cm / 8"
MAB08-020	= 25 cm / 9 3/4"

MAB08-030	= 13 cm / 5"
MAB08-031	= 14 cm / 5 1/2"
MAB08-032	= 16 cm / 6 1/4"

MAB08-033	= 13 cm / 5"
MAB08-034	= 14.5 cm / 5 3/4"
MAB08-035	= 16 cm / 6 1/4"

Doyen	MAB08-036	14.5 cm / 5 3/4"
Nelaton	MAB08-037	16 cm / 6 1/4"

2 mm Ø

MAB08-021	= 13 cm / 5"
MAB08-022	= 14.5 cm / 5 3/4"
MAB08-023	= 16 cm / 6 1/4"

Silber  
Silver  
Plata  
Argent  
Argento  
mit abgewinkelter Griffschlinge  
with angled handle loop  
con lazo acodado  
avec manche sous forme de  
anse, coudé  
con manico angolare ad ansa

2 mm Ø

MAB 08-024	= 13 cm / 5"
MAB 08-025	= 14.5 cm / 5 3/4"
MAB 08-026	= 14.5 cm / 5 3/4"
MAB 08-027	= 18 cm / 7"
MAB 08-028	= 20 cm / 8"

mit öhr  
with eye  
con ojete  
avec oeillet  
con ansa

MAB08-029  
10 cm / 4"  
1 mm Ø  
Ohrsonde  
Ear Probe  
Sonda auricular  
Sonde auriculaire  
Sona auricolare

Myrtenblattsonde  
Myrtle Leaf Probe  
Sonda de mirto  
Sonde feuille de myrte  
Sonda a foglia di mirto

Lockhart-Mummery MAB08-038 16.5 cm / 6 1/2" Fistel­sonden Fistula probes Sondas para fistula Sondes pour fistule Sonde per fistole	Lockhart-Mummery MAB08-039 16.5 cm / 6 1/2"	Lockhart-Mummery MAB08-040 16.5 cm / 6 1/2"	Lockhart-Mummery MAB 08-041 16.5 cm / 6 1/2"
---	---	---	--



Allgemeines Instrumentarium . General Instrumentation . Instrumental general  
**Varizeninstrumente**  
**Varix Instruments**  
**Instrumentos para varices**  
**Instruments pour varices**  
**Strumenti per varici**



MAB08-042 18 cm / 7" Phlebodissektor Phlebodisector Flebodisecador Dissecteur pour phlébite Flebo-dissettore **Varady**

MAB08-043 18 cm / 7" Phlebodissektor Phlebodisector Flebodisecador Dissecteur pour phlébite Flebo-estrattore

MAB08-044 18 cm / 7" Phlebodissektor Phlebodisector Flebodisecador Dissecteur pour phlébite Flebo-estrattore

MAB08-045 17.5 cm / 7" Mikro-Dissektor Micro Dissecador Micro dissecteur Micro- dissettore

MAB08-046 Mikro-Phlebextraktor Mini Phlebextraktor Mini Fleboextractor Extracteur pour phlébite mini Mini-estrattore per flebiti

MAB08-047 Mini-Phlebextraktor Mini Phlebextraktor Mini Fleboextractor Extracteur pour phlébite mini Mini-estrattore per flebiti

Allgemeines Instrumentarium . General Instrumentation . Instrumental general  
**Ringstripper**  
**Ring Strippers**  
**Fleboextractores**  
**Strippers à anneau**  
**Stripper anello**

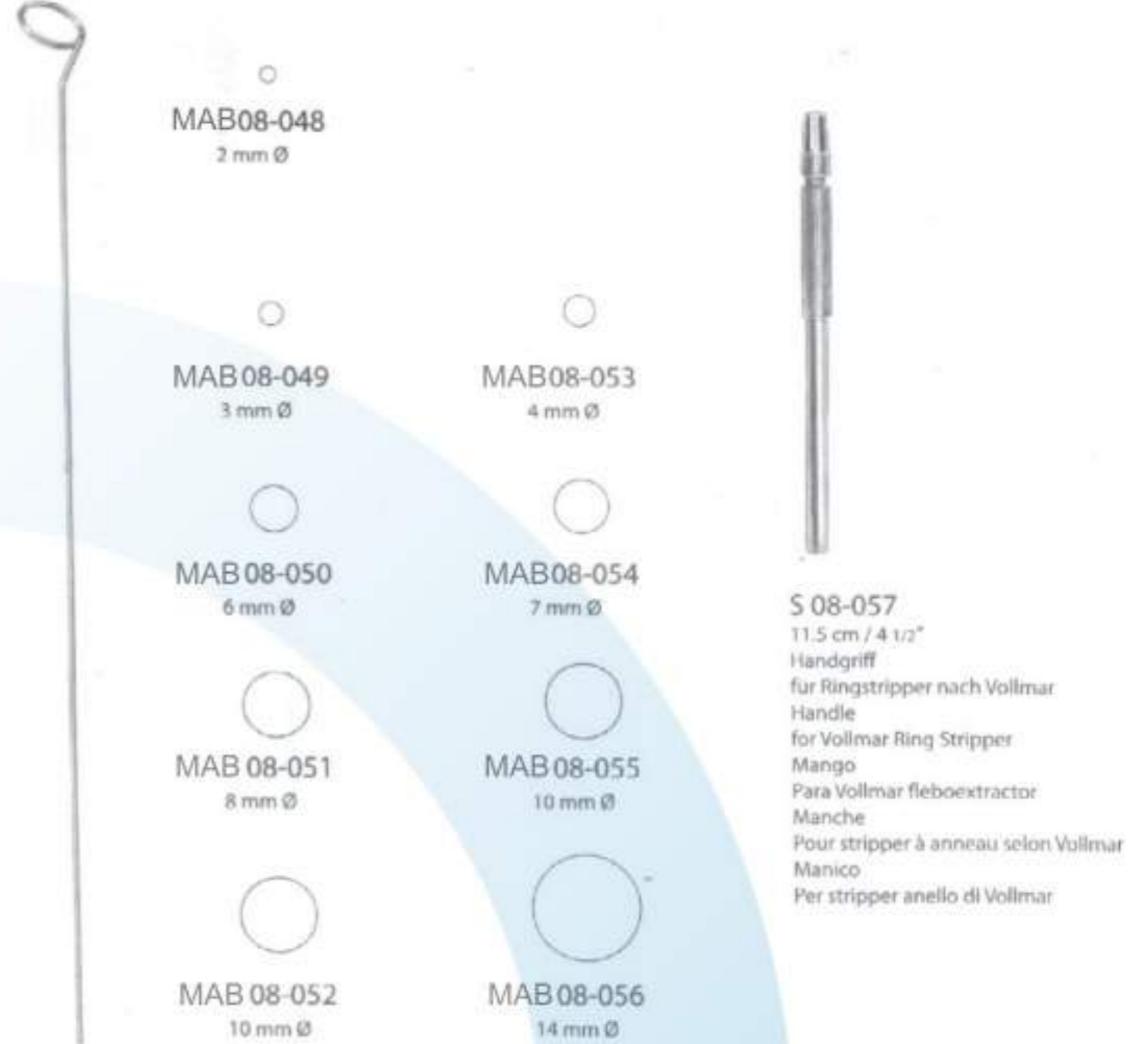

MAB08-048 2 mm Ø

MAB08-049 3 mm Ø

MAB08-050 6 mm Ø

MAB08-051 8 mm Ø

MAB08-052 10 mm Ø

MAB08-053 4 mm Ø

MAB08-054 7 mm Ø

MAB08-055 10 mm Ø

MAB08-056 14 mm Ø

Vollmar 50 cm / 19 3/4"

S 08-057 11.5 cm / 4 1/2" Handgriff für Ringstripper nach Vollmar Handle for Vollmar Ring Stripper Mango Para Vollmar fleboextractor Manche Pour stripper à anneau selon Vollmar Manico Per stripper anello di Vollmar

Allgemeines Instrumentarium . Instrumentation générale . Strumentario generale  
**Watteträger**  
**Cotton Applicators**  
**Porta algodones**  
**Porte-cotons**  
**Portacotrone**

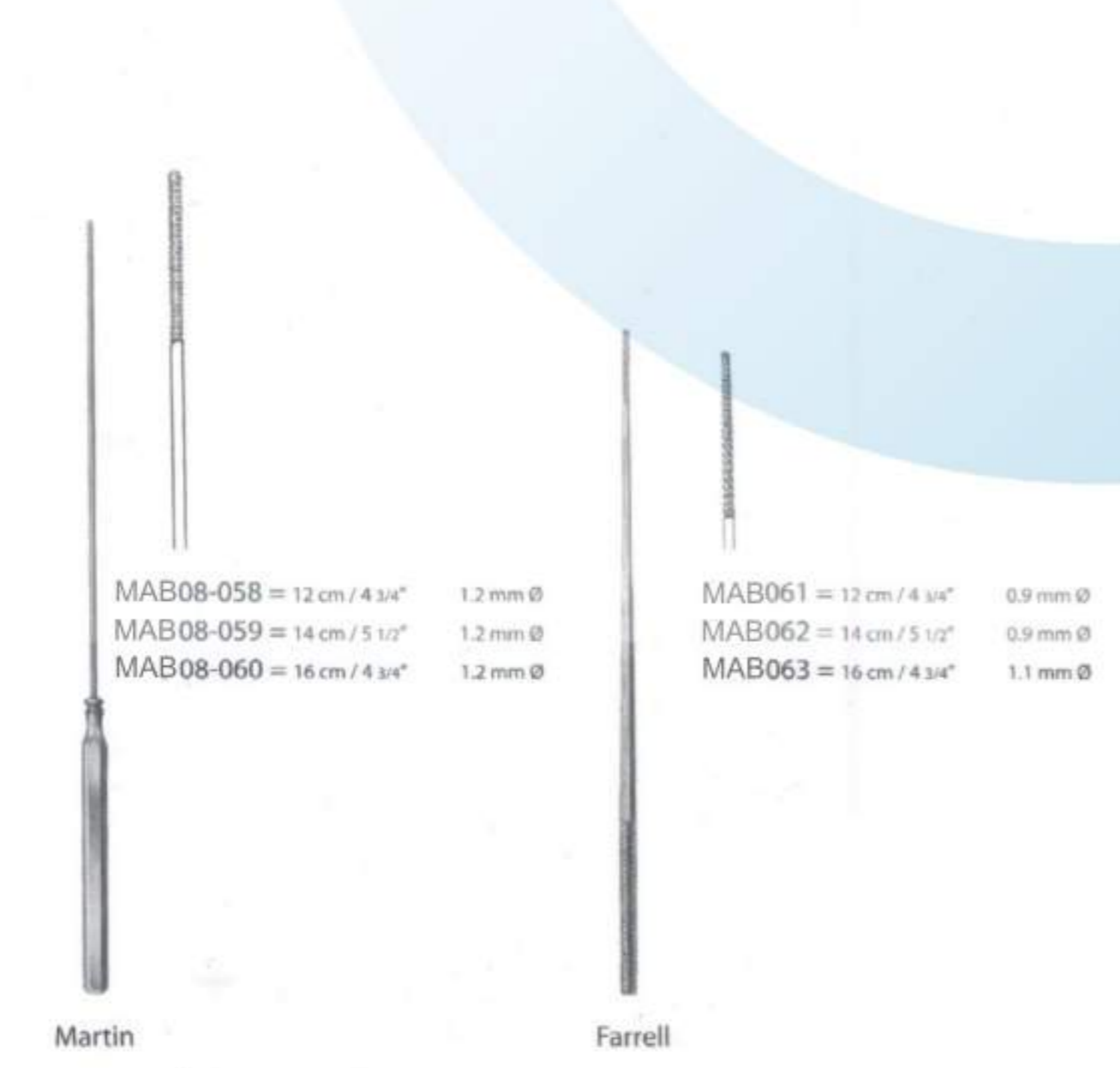

MAB08-058 = 12 cm / 4 3/4" 1.2 mm Ø

MAB08-059 = 14 cm / 5 1/2" 1.2 mm Ø

MAB08-060 = 16 cm / 4 3/4" 1.2 mm Ø

MAB061 = 12 cm / 4 3/4" 0.9 mm Ø

MAB062 = 14 cm / 5 1/2" 0.9 mm Ø

MAB063 = 16 cm / 4 3/4" 1.1 mm Ø

**Martin**

**Farrell**

## MAB 09

Saugrohre  
 Suction Tubes  
 Tubos de aspiracion  
 Tubes d'aspiration  
 Tubi d'aspirazione





Trokare, Sauger, Kanülen . Trocars, Suction Tubes, Cannulas . Trócares,  
Tubos de Aspiración, Cánulas  
Trokare  
Trocars  
Trócares  
Trocarts  
Trocarts  
Trequarti



**MAB9-001**  
14 cm / 5 1/2"  
mit 4 Trokaransätzen  
with 4 trocar tips  
con 4 puntas de trocar  
avec 4 embouts de trocarts  
con 4 punte di trequarti  
**1,7 3,0, 4,5 + 6,0 mm ø**

Universal



**Nelson**  
MAB9-002  
Fig. 1  
20 cm / 8"  
7.5 mm ø  
(22FG)



**Nelson**  
MAB9-003  
Fig. 2  
20 cm / 8"  
9.5 mm ø  
(28FG)



**Nelson**  
MAB 9-004  
Fig. 3  
20 cm / 8"  
11 mm ø  
(33FG)

Trequarti, Tubi d'aspirazion, Cannule  
Saugrohre  
Suction Cannulas  
Tubos de aspiración  
Tubes d'aspiration  
Tubi d'aspirazione



**MAB9-005**  
20 cm / 8"  
4 mm ø

Adson



**MAB9-006**  
24 cm / 9 1/2"  
3.3 mm ø  
Charr. 10

Frazier



**MAB9-007** 19.5 cm / 7 3/4" 2.0 mm ø Charr. 6  
**MAB9-008** 19.5 cm / 7 3/4" 2.3 mm ø Charr. 7  
**MAB9-009** 19.5 cm / 7 3/4" 2.6 mm ø Charr. 8  
**MAB9-010** 19.5 cm / 7 3/4" 3.0 mm ø Charr. 9  
**MAB9-011** 19.5 cm / 7 3/4" 3.3 mm ø Charr. 10  
**MAB9-012** 19.5 cm / 7 3/4" 3.6 mm ø Charr. 11  
**MAB9-013** 19.5 cm / 7 3/4" 4.0 mm ø Charr. 12

Frazier



**MAB9-014** 18 cm / 7" 2.0 mm ø Charr. 6  
**MAB9-015** 18 cm / 7" 3.3 mm ø Charr. 10  
**MAB9-016** 18 cm / 7" 4.0 mm ø Charr. 12

Poppen

Trokare, Sauger, Kanülen . Trocars, Suction Tubes, Cannulas . Trócares,  
Tubos de Aspiración, Cánulas  
Sauger, Saugrohre  
Suction Tubes  
Tubos de aspiración  
Tubes d'aspiration  
Tubi d'aspirazione



**MAB9-017**  
14 cm / 5 1/2"  
komplett  
complete  
completo  
complet  
completo  
mit Griff und drei Aufsätzen  
with handle and 3 tips  
con mango y 3 puntas  
avec manche et 3 pointes  
con manico e 3 punte

Wullstein



**MAB9-018**  
14 cm / 5 1/2"  
Saugerhandgriff  
Suction Handle  
Mango para cánula de aspiración  
Manche pour canule d'aspiration  
Manico d'aspirazione

Luer

Trokare, Sauger, Kanülen . Trocars, Tubes d'aspiration, Canulas .  
Trequarti, Tubi d'aspirazion, Cannule  
Saugrohre  
Suction Tubes  
Tubos de aspiración  
Tubes d'aspiration  
Tubi d'aspirazione

Nutzlänge 110 mm  
working length 110 mm  
largo útil 110 mm  
longueur utile 110 mm  
lunghezza utile 110 mm



**MAB 9-025**  
konisch  
conical  
cónico  
conique  
conico  
3.0 mm ø



**MAB 9-026**  
konisch  
conical  
cónico  
conique  
conico  
3.5 mm ø



**MAB 9-027**  
konisch  
conical  
cónico  
conique  
conico  
4.5 mm ø



**MAB9-019**  
4.5 cm / 1 3/4"



**MAB9-020**  
4.5 cm / 1 3/4"



**MAB9-021**  
4.5 cm / 1 3/4"

Mikro-Saugkanüle  
Micro Suction Cannula  
Micro tubo de aspiración  
Tube micro d'aspiration  
Micro-cannula d'aspirazione  
0.4 mm ø      0.6 mm ø      0.8 mm ø



**Baron-Schuknecht**

Nutzlänge 75 mm  
mit Unterbrecher  
working length 75mm  
with finger cut-off  
largo útil 75 mm  
con placa desconectadora  
longueur utile 75 mm  
avec plaque interrupteur  
lunghezza utile 75 mm  
con placa interruttore

**MAB9-022**  
1.0 mm ø

**MAB9-023**  
1.5 mm ø

**MAB9-024**  
2.0 mm ø

Yasargil

Nutzlänge 150 mm  
mit Luer-Bohrung  
working length 150 mm  
with Luer hub  
largo util 150mm  
con cono Luer  
longueur utile 150 mm  
avec perforation Luer  
lunghezza utile 150 mm  
cono Luer

**MAB9-028**  
21.5 cm / 8 1/2"  
1.5 mm ø

**MAB9-030**  
21.5 cm / 8 1/2"  
2.5 mm ø

**MAB9-029**  
21.5 cm / 8 1/2"  
2.0 mm ø

**MAB9-031**  
21.5 cm / 8 1/2"  
3.5 mm ø



Trokare, Sauger, Kanülen . Trocars, Suction Tubes, Cannulas . Trócares, Tubos de Aspiración, Cánulas  
 sauger  
 Suction Tubes  
 Tubos de aspiración  
 Tubes d'aspiration  
 Tubi d'aspirazione

MAB9-032  
 Saugspitze  
 Suction Tip  
 Cabezal para aspiración  
 Pointe de succion  
 Punta per aspirazione



MAB9-033 Fig.0 10 cm / 4"  
 MAB9-034 Fig.1 10 cm / 4"  
 MAB9-035 Fig.2 10 cm / 4"  
 MAB9-036 Fig.3 13.5 cm / 5 1/4"

Trokare, Sauger, Kanülen . Trocars, Tubes d'aspiration, Canules . Trequarti, Tubi d'aspirazione, Cannule  
 Sauger  
 Suction Tubes  
 Tubos de aspiración  
 Tubes d'aspiration  
 Tubi d'aspirazione

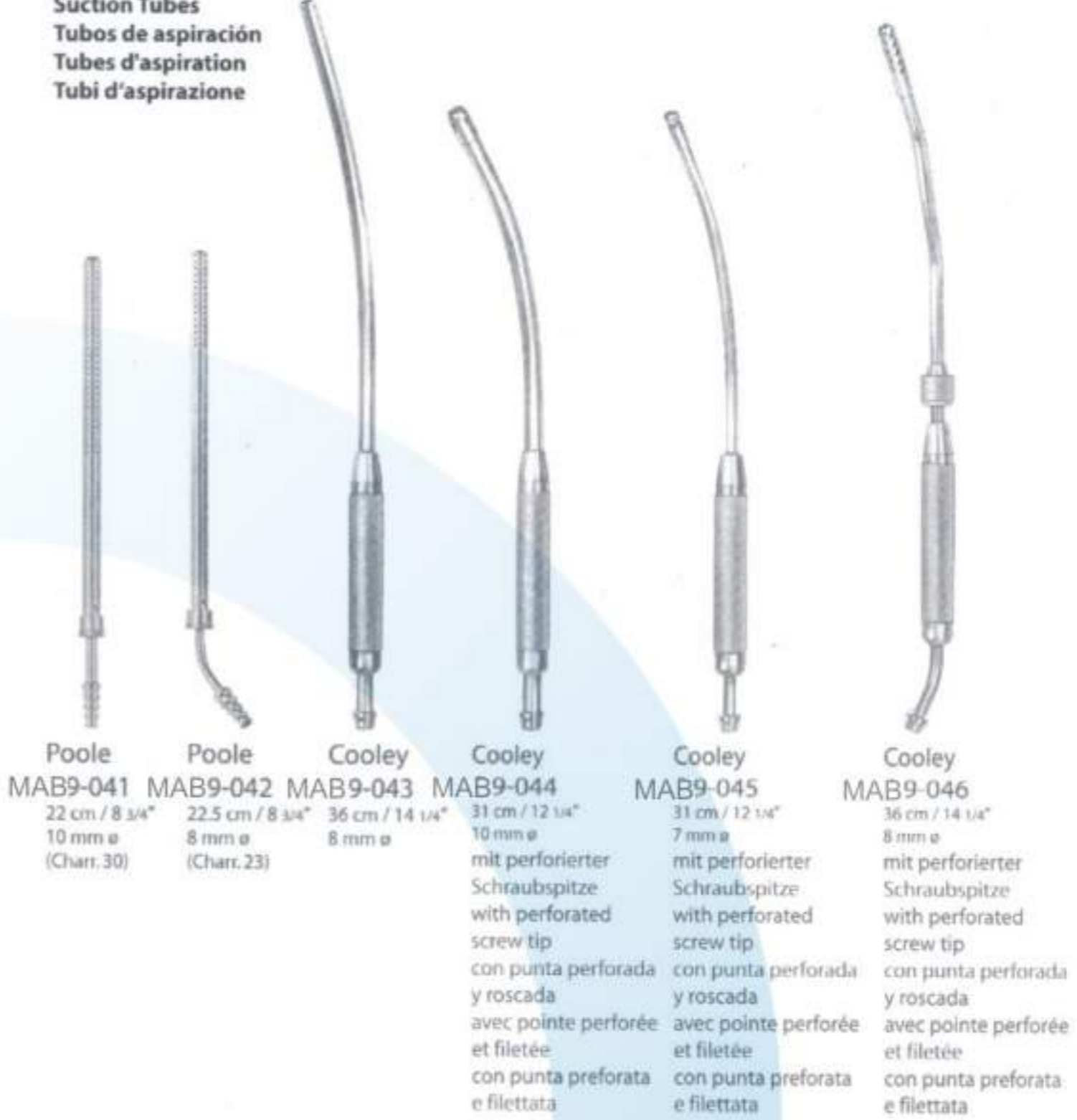

Pooler MAB9-041 22 cm / 8 3/4" 10 mm ø (Charr.30)  
 Pooler MAB9-042 22.5 cm / 8 3/4" 8 mm ø (Charr.23)  
 Cooley MAB9-043 36 cm / 14 1/4" 8 mm ø  
 Cooley MAB9-044 31 cm / 12 1/4" 10 mm ø mit perforierter Schraubspitze with perforated screw tip con punta perforada y roscada avec: pointe perforée et fileté con punta preforata e filettata  
 Cooley MAB9-045 31 cm / 12 1/4" 7 mm ø mit perforierter Schraubspitze with perforated screw tip con punta perforada y roscada avec pointe perforée et fileté con punta preforata e filettata  
 Cooley MAB9-046 36 cm / 14 1/4" 8 mm ø mit perforierter Schraubspitze with perforated screw tip con punta perforada y roscada avec pointe perforée et fileté con punta preforata e filettata

Yankauer MAB9-037 31 cm / 12 1/4" komplett mit Saugspitze und Schlaucholive complete with suction tip and connector completo con punta de succión y conector complet avec pointe de succion et raccord completi con punte d'aspirazione e raccordo

Yankauer MAB9-038 31 cm / 12 1/4" komplett mit Griff, 4 Saugrohren, Saugspitze und Schlaucholive complete with handle, 4 tubes, suction tip and tube connector completo con mango, 4 tubos, punta de succión y conector para tubos complet avec manche, 4 tubes, pointe de succion et raccord pour tubes completi con manico, 4 tubi, punta per aspirazione e raccordo per tubi

Yankauer MAB9-039 15 cm / 6" Handgriff Mango Manche Manico  
 Yankauer MAB9-040 2.5 cm / 1" Schlaucholive Olive Oliva Oliva

Trokare, Sauger, Kanülen . Trocars, Suction Tubes, Cannulas . Trócares, Tubos de Aspiración, Cánulas  
 Saugrohre, Saugeraufsätze  
 Suction Tubes, Suction Tips  
 Tubos de aspiración, Punta de succión  
 Tubes d'aspiration, Pointe de succión  
 Tubi d'aspirazione, Punta per aspirazione



Nuboer MAB9-051 21 cm / 8 1/4" 6 mm ø runde Öffnung round opening abertura redonda ouverture ronde apertura totonda  
 Nuboer MAB9-052 21 cm / 8 1/4" 6 mm ø ovale Öffnung oval opening abertura ovalada ouverture ovale apertura ovale  
 Coupland MAB9-053 17 cm / 6 3/4" Saugerhandgriff mit Schlauchansatz Suction Handle with tube connector Mango para tubos de aspiración con conexión para tub Manche pour tubes d'aspiration avec connection pour Manico per aspirazione con raccordo per tubi

MAB9-047 9 cm / 3 1/2" 1.5 mm ø  
 MAB9-048 9 cm / 3 1/2" 2.0 mm ø  
 MAB9-049 9 cm / 3 1/2" 2.5 mm ø  
 MAB9-050 9 cm / 3 1/2" 3.5 mm ø

## MAB 10

Naht  
 Suture  
 Sutura  
 Suture  
 Sutura

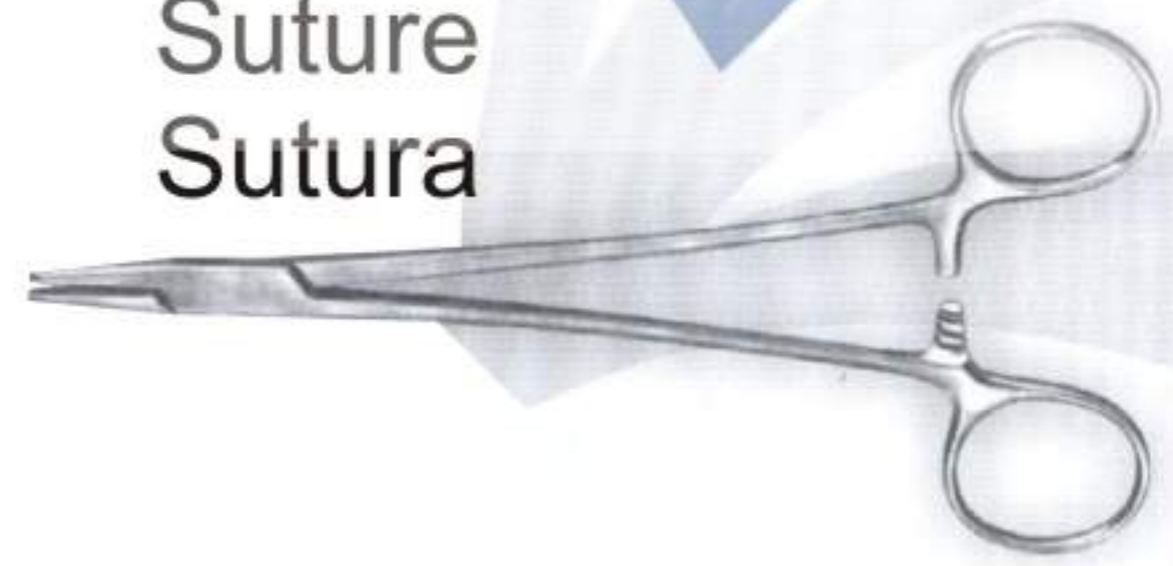



Naht . Suture . Sutura  
Mikro-Nadelhalter  
Micro Needle Holders  
Mecro Porta-agujas  
Micro Porte-aiguilles  
Micro Portaghi



**Titanium**



mit Sperre  
with lock  
con cierre  
avec serrure  
con fermo

Stahl . Steel . Acero . Acier . Acciaio  
15 cm / 6" MAB10-001 MAB10-002 MAB10-003 MAB10-004

Titan . Titanium . Titanio . Titane . Titanio  
15 cm / 6" MAB10-005 MAB10-006 MAB10-007 MAB10-008

Stahl . Steel . Acero . Acier . Acciaio  
18 cm / 7" MAB10-009 MAB10-010 MAB10-011 MAB10-012

Titan . Titanium . Titanio . Titane . Titanio  
18 cm / 7" MAB10-013 MAB10-014 MAB10-015 MAB10-016

diamantiertes Maul  
diamond-coated jaw  
boca diamantada  
mors diamanté  
morso diamantato  
11.0 x 0.4 mm

Naht . Suture . Sutura  
Mikro-Nadelhalter  
Micro Needle Holders  
Mecro Porta-agujas  
Micro Porte-aiguilles  
Micro Portaghi



**Titanium**



mit Sperre  
with lock  
con cierre  
avec serrure  
con fermo

Stahl . Steel . Acero . Acier . Acciaio  
15 cm / 6" MAB10-017 MAB10-018 MAB10-019 MAB10-020

Titan . Titanium . Titanio . Titane . Titanio  
15 cm / 6" MAB10-021 MAB10-022 MAB10-023 MAB10-024

Stahl . Steel . Acero . Acier . Acciaio  
18 cm / 7" MAB10-025 MAB10-026 MAB10-027 MAB10-028

Titan . Titanium . Titanio . Titane . Titanio  
18 cm / 7" MAB10-029 MAB10-030 MAB10-031 MAB10-032

Stahl . Steel . Acero . Acier . Acciaio  
15 cm / 6" MAB10-033 MAB10-034 MAB10-035 MAB10-036

Titan . Titanium . Titanio . Titane . Titanio  
15 cm / 6" MAB10-037 MAB10-038 MAB10-039 MAB10-040

Stahl . Steel . Acero . Acier . Acciaio  
18 cm / 7" MAB10-041 MAB10-042 MAB10-043 MAB10-044

diamantiertes Maul  
diamond-coated jaw  
boca diamantada  
mors diamanté  
morso diamantato  
11.0 x 0.8 mm

Naht . Suture . Sutura  
Nadelhalter, Mikro-Nadelhalter  
Needle Holders, Micro Needle Holders  
Porta-agujas, Micro porta-agujas  
Porte-aiguilles, Micro Porte-aiguilles  
Micro Portaghi



Kalt  
MAB10-049  
13.5 cm / 5 1/4"



Barraquer-Troutman



MAB10-045 10 cm / 4"  
MAB10-046 10.5 cm / 4"



Arruga



MAB10-047 13.5 cm / 5 1/4"  
MAB10-048 13.5 cm / 5 1/4"

Naht . Suture . Sutura  
Mikro-Nadelhalter  
Micro Needle Holders  
Mecro Porta-agujas  
Micro porte-aiguilles  
Micro portaghi



Barraquer



MAB10-057  
13.5 cm / 5 1/4"



Castroviejo-Fino



MAB10-058  
13 cm / 5"



Castroviejo-Fino

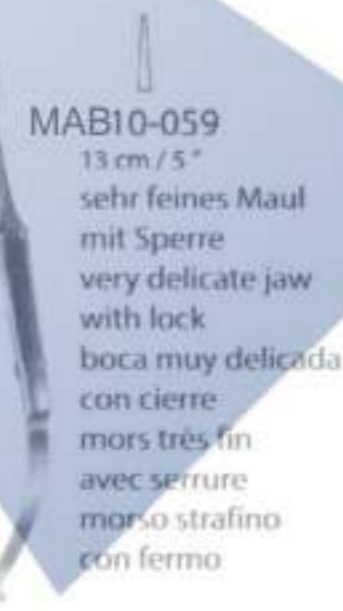

MAB10-059  
13 cm / 5"  
sehr feines Maul  
mit Sperre  
very delicate jaw  
with lock  
boca muy delicada  
con cierre  
mors très fin  
avec serrure  
morso strafino  
con fermo



Castroviejo-Fino



MAB10-060  
13 cm / 5"  
sehr feines Maul  
mit Sperre  
very delicate jaw  
with lock  
boca muy delicada  
con cierre  
mors très fin  
avec serrure  
morso strafino  
con fermo



MAB10-050 10.5 cm / 4"  
MAB10-051 11.5 cm / 4 1/2"



MAB10-055 10.5 cm / 4"  
MAB10-056 11.5 cm / 4 1/2"

Barraquer-Troutman



Barraquer



MAB10-052 11.5 cm / 4 1/2"  
MAB10-053 13.5 cm / 5 1/4"  
MAB10-054 14 cm / 5 1/2"



MAB10-061 MAB10-062  
14 cm / 5 1/2" 14 cm / 5 1/2"

Castroviejo

mit Sperre  
with lock  
con cierre  
avec serrure  
con fermo



MAB10-063 MAB10-064  
14 cm / 5 1/2" 14 cm / 5 1/2"

Castroviejo



MAB10-065 MAB10-066  
14 cm / 5 1/2" 14 cm / 5 1/2"

Castroviejo

mit Sperre  
with lock  
con cierre  
avec serrure  
con fermo



Naht . Suture . Sutura  
 Mikro-Nadelhalter, Nadelhalter  
 Micro Needle Holders, Needle Holders  
 Micro Porta-agujas, Porta-agujas  
 Micro porte-aiguilles, Porte-aiguilles  
 Micro portaghi, Portaghi



MAB10-067  
14 cm / 5 1/2"



MAB10-068 MAB10-069  
16 cm / 6 1/4" 16 cm / 6 1/4"

fein  
delicate  
fino  
fin  
fino

Naht . Suture . Sutura  
 Nadelhalter  
 Needle Holders  
 Porta-agujas  
 Porte-aiguilles  
 Portaghi



MAB10-074  
12.5 cm / 5"  
mit Längskehle im Maul  
grooved jaw  
boca acanalada  
mors strié  
morso scannellato



MAB10-075  
13 cm / 5"  
glattes Maul  
smooth jaw  
boca lisa  
mors lisse  
morso liscio



MAB10-070  
12 cm / 4 3/4"  
mit Sperre  
with lock  
con cierre  
avec serrure  
con fermo



MAB10-071  
12 cm / 4 3/4"  
mit Sperre  
with lock  
con cierre  
avec serrure  
con fermo



MAB10-072  
12 cm / 4 3/4"  
ein Maulteil  
gefenstert  
one fenestrated jaw  
un lado de la boca  
fenestrada  
un côté de mors  
fenêtré  
una parte del morso  
finestrato



MAB10-073  
13 cm / 5"  
längsgerieftes Maul  
jaw with longitudinal  
seration  
boca con estrías  
longitudinales  
mors avec rainures  
longitudinales  
morso con strie  
longitudinali

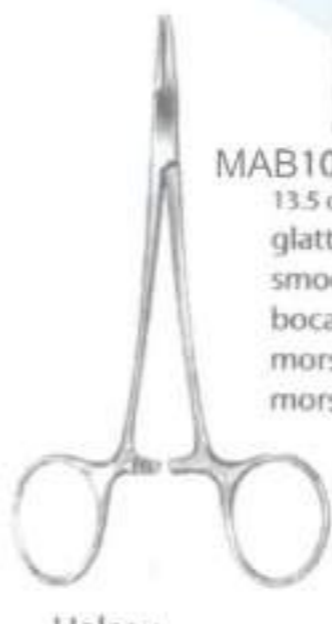

MAB10-076  
13.5 cm / 5 1/4"  
glattes Maul  
smooth jaw  
boca lisa  
mors lisse  
morso liscio



MAB10-077  
12.5 cm / 5"  
glattes Maul mit Spezialkehlung  
smooth jaw, special groove  
boca lisa, especialmente acanalada  
mors lisse, avec stries spéciales  
morso liscio con scannellatura  
speciale

Naht . Suture . Sutura  
 Nadelhalter  
 Needle Holders  
 Porta-agujas  
 Porte-aiguilles  
 Portaghi



MAB10-078  
14.5 cm / 5 3/4"



MAB10-079 MAB10-080  
13 cm / 5" 18 cm / 7"  
kräftiges Modell  
heavy pattern  
modelo fuerte  
modèle fort  
modello forte  
Maul diagonal gerieft  
diagonally serrated jaw  
boca estriada transversalmente  
mors strié transversalement  
con strie diagonali

Naht . Suture . Sutura  
 Nadelhalter  
 Needle Holders  
 Porta-agujas  
 Porte-aiguilles  
 Portaghi



MAB10-083  
18 cm / 7"  
ein Maulteil gefenestert  
one fenestrated jaw  
un lado de la boca fenestrada  
un côté de mors fenêtré  
una parte del morso finestrata

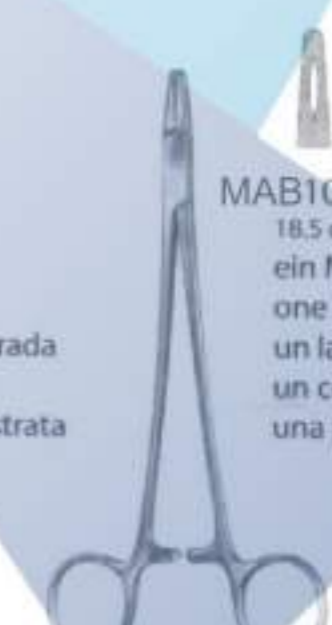

MAB10-084  
18.5 cm / 7 1/4"  
ein Maulteil gekehlt und gefenestert  
one grooved and fenestrated jaw  
un lado de la boca acanalado y fenestrado  
un côté de mors strié et fenêtré  
una parte del morso scannellata e finestrata



MAB10-081  
15 cm / 6"  
schlankes Modell  
slender pattern  
modelo delgado  
modèle gracile  
modello gracile



MAB10-082  
15 cm / 6"



MAB10-085  
17.5 cm / 6 3/4"  
kräftiges Modell  
heavy pattern  
modelo fuerte  
modèle fort  
modello forte



MAB10-086 MAB10-087 MAB10-088  
14.5 cm / 5 3/4" 16 cm / 6 1/4" 18.5 cm / 7 1/4"

MAB10-089 MAB10-090 MAB10-091  
20.5 cm / 8" 24 cm / 9 1/2" 26.5 cm / 10 1/2"

MAB10-092  
30.5 cm / 12"



Naht . Sutura . Sutura  
Nadelhalter  
Needle Holders  
Porta-agujas  
Porte-aiguilles  
Portaghi



Naht . Sutura . Sutura  
Nadelhalter  
Needle Holders  
Porta-agujas  
Porte-aiguilles  
Portaghi



Naht . Sutura . Sutura  
Nadelhalter  
Needle Holders  
Porta-agujas  
Porte-aiguilles  
Portaghi



Naht . Sutura . Sutura  
Nadelhalter  
Needle Holders  
Porta-agujas  
Porte-aiguilles  
Portaghi

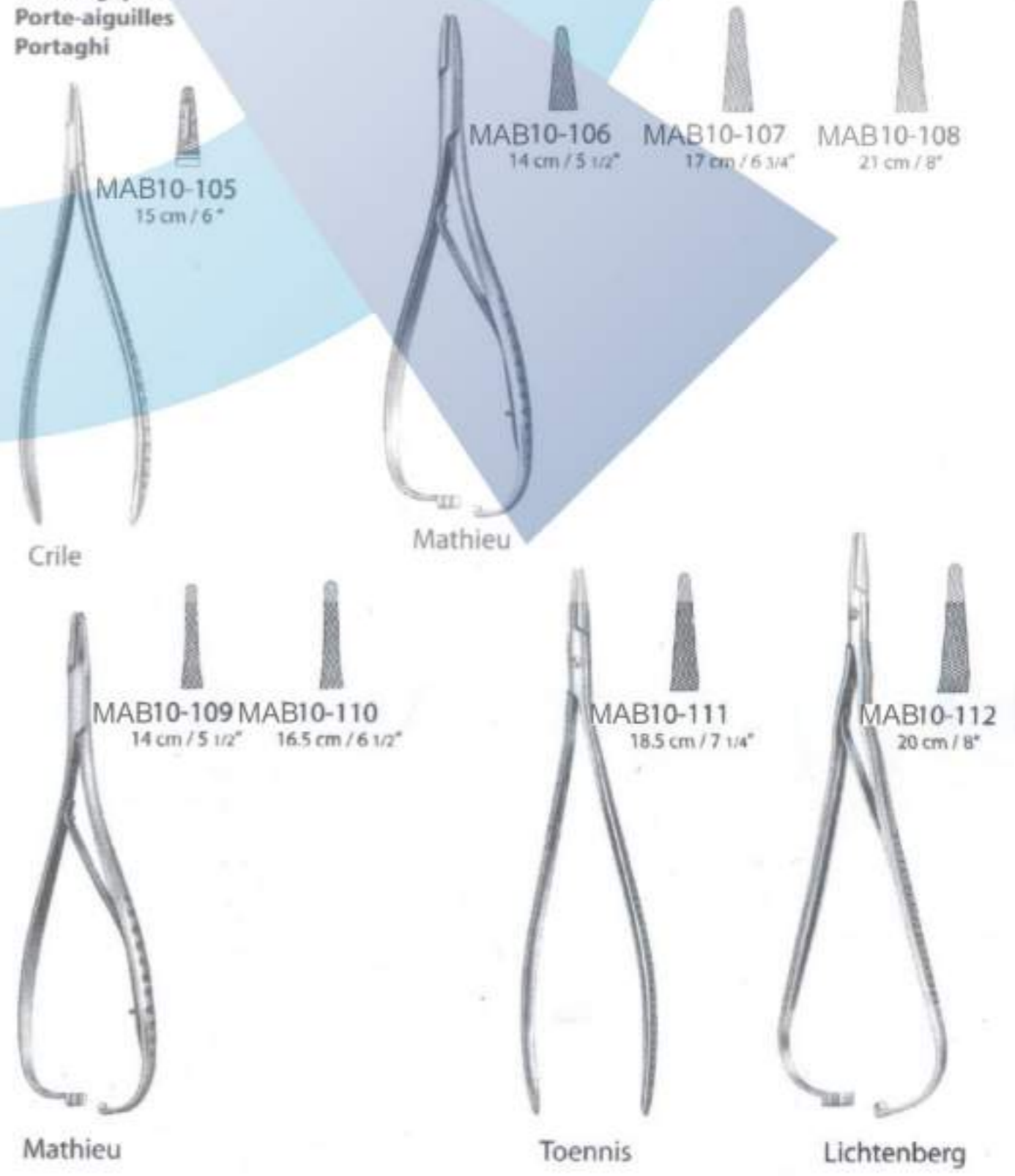



Naht . Suture . Sutura  
Mikro-Nadelhalter  
Micro Needle Holders  
Micro Porta-agujas  
Micro Porte-aiguilles  
Micro Portaghi



**MAB10-113**  
16 cm / 6 1/2"

glattes, gebogenes Maul  
smooth, curved jaw  
boca lisa y curva  
mors lisse, courbé  
morso liscio, curvo

**MAB10-114**  
23 cm / 9"

glattes, gerades Maul  
smooth, straight jaw  
boca lisa y recta  
mors lisse, droit  
morso liscio, retto

**MAB10-115**  
23 cm / 8"

glattes, gebogene Maul  
smooth, curved jaw  
boca lisa y curva  
mors lisse, courbé  
morso liscio, curvo

**MAB10-116**  
19 cm / 7 1/2"

## MAB 11

Nadelhalter  
Needle Holders  
Porta-agujas  
Porte-aiguilles  
Portaghi



Naht . Suture . Sutura  
Mikro-Nadelhalter, Nadelhalter  
Micro Needle Holders, Needle Holders  
Micro porta-agujas, Porta-agujas  
Micro porte-aiguilles, Porte-aiguilles  
Micro portaghi, portaghi

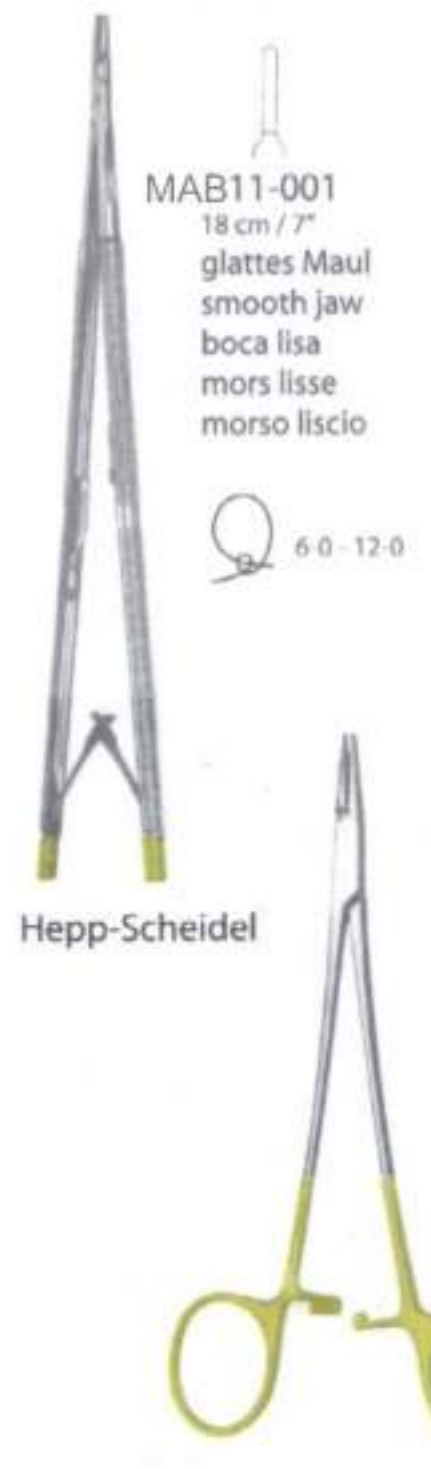

**MAB11-001**  
18 cm / 7"

glattes Maul  
smooth jaw  
boca lisa  
mors lisse  
morso liscio

Q 6.0 - 12.0

Hepp-Scheidel

**Webster**  
**MAB11-002**  
13 cm / 5"

Miniprofil  
mini profile  
profilo mini  
mit Durchdrückspere  
auch für Linkshänder  
geeignet  
with automatic release ratchet  
also for lefthanders  
con cremallera automática  
tambien para zurdos  
avec cremaillère automatique  
aussi pour gauchers  
con cremagliera automatica  
anche per mancini

**Crile-Wood**  
**MAB11-003**  
15 cm / 6"

**MAB11-004**  
18 cm / 7"

mit sperre  
with lock  
con cierre  
avec serrure  
con fermo  
Mikroprofil  
micro profile  
profilo micro

JABOMA

Naht . Suture . Sutura  
Mikro-Nadelhalter  
Micro Needle Holders  
Micro porta-agujas  
Micro porte-aiguilles  
Micro portaghi

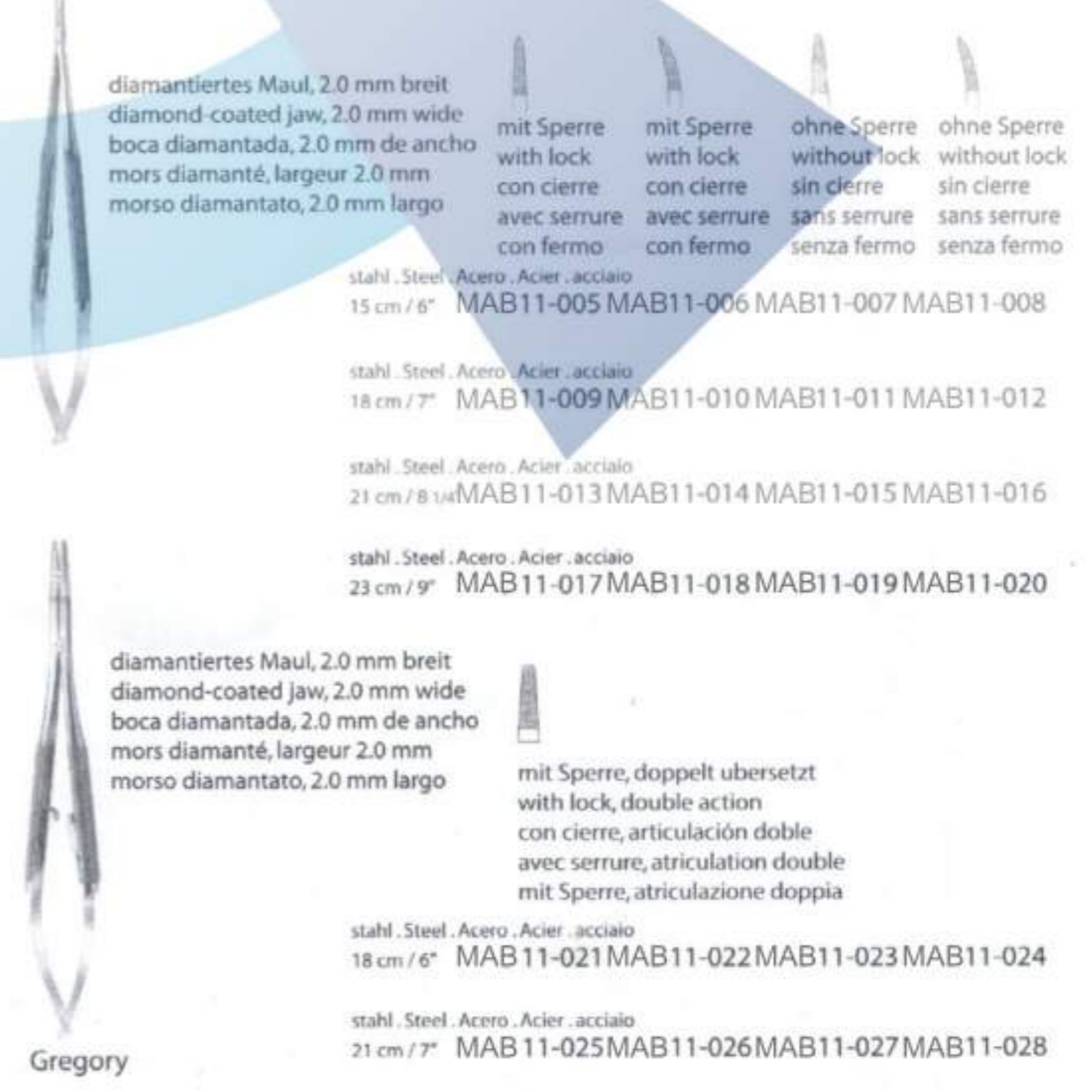

diamantiertes Maul, 2.0 mm breit  
diamond-coated jaw, 2.0 mm wide  
boca diamantada, 2.0 mm de ancho  
mors diamanté, largeur 2.0 mm  
morso diamantato, 2.0 mm largo

mit Sperre  
with lock  
con cierre  
avec serrure  
con fermo

mit Sperre  
with lock  
con cierre  
avec serrure  
con fermo

ohne Sperre  
without lock  
sin cierre  
sans serrure  
senza fermo

ohne Sperre  
without lock  
sin cierre  
sans serrure  
senza fermo

stahl . Steel . Acero . Acier . acciaio  
15 cm / 6" MAB11-005 MAB11-006 MAB11-007 MAB11-008

stahl . Steel . Acero . Acier . acciaio  
18 cm / 7" MAB11-009 MAB11-010 MAB11-011 MAB11-012

stahl . Steel . Acero . Acier . acciaio  
21 cm / 8 1/4" MAB11-013 MAB11-014 MAB11-015 MAB11-016

stahl . Steel . Acero . Acier . acciaio  
23 cm / 9" MAB11-017 MAB11-018 MAB11-019 MAB11-020

diamantiertes Maul, 2.0 mm breit  
diamond-coated jaw, 2.0 mm wide  
boca diamantada, 2.0 mm de ancho  
mors diamanté, largeur 2.0 mm  
morso diamantato, 2.0 mm largo

mit Sperre, doppelt ubersetzt  
with lock, double action  
con cierre, articulación doble  
avec serrure, atriculation double  
mit Sperre, atriculatione doppia





stahl . Steel . Acero . Acier . acciaio  
18 cm / 6" MAB11-021 MAB11-022 MAB11-023 MAB11-024

stahl . Steel . Acero . Acier . acciaio  
21 cm / 7" MAB11-025 MAB11-026 MAB11-027 MAB11-028

Gregory



Naht . Suture . Sutura  
Mikro-Nadelhalter  
Micro Needle Holders  
Micro porta-agujas  
Micro porte-aiguilles  
Micro portaghi

- |  |  |  |  |  |
|--|--|--|--|--|
|   |   |                       |   |   |
| MAB11-029<br>14.5 cm / 5 3/4"<br>mit sperre<br>with lock<br>con cierre<br>avec serrure<br>con fermo<br>Mikroprofil<br>micro profile<br>perfil micro<br>profil micro<br>profilo micro | MAB11-030<br>14.5 cm / 5 3/4"<br>mit sperre<br>with lock<br>con cierre<br>avec serrure<br>con fermo<br>Mikroprofil<br>micro profile<br>perfil micro<br>profil micro<br>profilo micro | MAB11-031<br>14.5 cm / 5 3/4"<br>glattes Maul<br>smooth jaw<br>boca lisa<br>mors lisse<br>morso liscio | MAB11-032<br>18 cm / 7"<br>mit sperre<br>with lock<br>con cierre<br>avec serrure<br>con fermo<br>Mikroprofil<br>micro profile<br>perfil micro<br>profil micro<br>profilo micro | MAB11-033<br>21.5 cm / 8 1/2"<br>mit sperre<br>with lock<br>con cierre<br>avec serrure<br>con fermo<br>Mikroprofil<br>micro profile<br>perfil micro<br>profil micro<br>profilo micro |

Naht . Suture . Sutura  
Nadelhalter, Mikro-Nadelhalter  
Needle Holders, Micro Needle Holders  
Porta-agujas, Micro Porta-agujas  
Porte-aiguilles, Micro porte-aiguilles  
Portaghi, Micro Portaghi

TC GOLD

- |   |   |  |  |
|---|---|--|--|
|                      |  |   |   |
| MAB11-037<br>16 cm / 6 1/4"<br>Miniprofil<br>mini profile<br>perfil mini<br>profil mini<br>profilo mini | MAB11-038<br>16 cm / 6 1/4"   | MAB11-039<br>12.5 cm / 5"<br>mit sperre, glattes Maul<br>with lock, smooth jaw<br>con cierre, boca lisa<br>avec serrure, mors lisse<br>con fermo, morso liscio | MAB11-040<br>13 cm / 5"<br>mit sperre, glattes Maul<br>with lock, smooth jaw<br>con cierre, boca lisa<br>avec serrure, mors lisse<br>con fermo, morso liscio |



- |  |  |  |
|--|--|--|
|                      |    |    |
| MAB11-034<br>14.5 cm / 5 3/4"<br>glattes Maul<br>smooth jaw<br>boca lisa<br>mors lisse<br>morso liscio | MAB11-035<br>18 cm / 7"<br>mit sperre<br>with lock<br>con cierre<br>avec serrure<br>con fermo<br>Mikroprofil<br>micro profile<br>perfil micro<br>profil micro<br>profilo micro | MAB11-036<br>21.5 cm / 8 1/2"<br>mit sperre<br>with lock<br>con cierre<br>avec serrure<br>con fermo<br>Mikroprofil<br>micro profile<br>perfil micro<br>profil micro<br>profilo micro |

Arruga



- |  |
|--|
|             |
| MAB11-041<br>13 cm / 5"<br>glattes Maul<br>smooth jaw<br>boca lisa<br>mors lisse<br>morso liscio |



- |  |
|--|
|             |
| MAB11-042<br>13 cm / 5"<br>glattes Maul<br>smooth jaw<br>boca lisa<br>mors lisse<br>morso liscio |

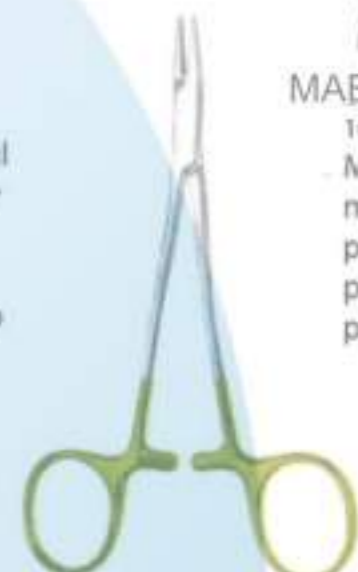

- |   |
|---|
|                    |
| MAB11-043<br>16 cm / 6 1/4"<br>Miniprofil<br>mini profile<br>perfil mini<br>profil mini<br>profilo mini |

Naht . Suture . Sutura  
Nadelhalter  
Needle Holders  
porta-agujas  
porte-aiguilles  
portaghi

TC GOLD

- |   |
|---|
|                      |
| MAB11-044<br>12 cm / 4 3/4"<br>Miniprofil<br>mini profile<br>perfil mini<br>profil mini<br>profilo mini |

Derf



- |   |   |
|---|---|
|                  |                        |
| MAB11-045<br>13 cm / 5"<br>Miniprofil<br>mini profile<br>perfil mini<br>profil mini<br>profilo mini | MAB11-046<br>14.5 cm / 5 3/4"<br>Miniprofil<br>mini profile<br>perfil mini<br>profil mini<br>profilo mini |

Naht . Suture . Sutura  
Nadelhalter  
Needle Holders  
porta-agujas  
porte-aiguilles  
portaghi

- |   |
|---|
|                  |
| MAB11-051<br>20.5 cm / 8"<br>Miniprofil<br>mini profile<br>perfil mini<br>profil mini<br>profilo mini |

Crile-Wood



- |   |   |   |
|---|---|---|
|  |  |  |
| MAB11-052<br>18 cm / 7"   | MAB11-053<br>20 cm / 8"   | MAB11-054<br>26 cm / 10 1/4"  |

Normalprofil  
standard profile  
perfil estándar  
profil normal  
profilo normale



- |  |
|--|
|               |
| MAB11-047<br>13 cm / 5"<br>glattes Maul<br>smooth jaw<br>boca lisa<br>mors lisse<br>morso liscio |

- |   |
|---|
|                  |
| MAB11-048<br>13 cm / 5"<br>Miniprofil<br>mini profile<br>perfil mini<br>profil mini<br>profilo mini |





- |  |
|--|
|                   |
| MAB11-049<br>12 cm / 4 3/4"<br>glattes Maul<br>smooth jaw<br>boca lisa<br>mors lisse<br>morso liscio |

- |   |
|---|
|                  |
| MAB11-050<br>15 cm / 6"<br>Miniprofil<br>mini profile<br>perfil mini<br>profil mini<br>profilo mini |



- |   |   |   |
|---|---|---|
|  |  |  |
| MAB11-055<br>16 cm / 6 1/4"   | MAB11-056<br>18 cm / 7"   | MAB11-057<br>20 cm / 8"   |

- |   |   |   |
|---|---|---|
|  |  |  |
| MAB11-061<br>24 cm / 9 1/2"   | MAB11-062<br>26 cm / 10 1/4"  | MAB11-063<br>30 cm / 11 3/4"  |

Normalprofil  
standard profile  
perfil estándar  
profil normal  
profilo normale



- |   |   |   |
|---|---|---|
|  |  |  |
| MAB11-058<br>20 cm / 8"   | MAB11-059<br>24 cm / 9 1/2"   | MAB11-060<br>26 cm / 10 1/4"  |

Normalprofil  
standard profile  
perfil estándar  
profil normal  
profilo normale



Naht . Suture . Sutura  
Nadelhalter  
Needle Holders  
Porta-agujas  
Porte-aiguilles  
Portaghi

schlankes Modell  
Miniprofil  
delicate pattern  
mini profile  
modelo delgado  
perfil mini  
modèle gracile  
profilo mini  
modelo gracile  
profilo mini

MAB11-064 18 cm / 7"  
MAB11-065 20 cm / 8"  
MAB11-066 23 cm / 9"

MAB11-067 26 cm / 10 1/4"  
MAB11-068 31 cm / 12 1/4"



DeBakey

Miniprofil  
mini profile  
profil mini  
profilo mini

MAB11-069 12.5 cm / 5"  
MAB11-070 15 cm / 6"  
MAB11-071 18 cm / 7"

MAB11-072 20 cm / 8"  
MAB11-073 23 cm / 9"  
MAB11-074 26 cm / 10 1/4"



Ryder (Martin)

Naht . Suture . Sutura  
Nadelhalter  
Needle Holders  
Porta-agujas  
Porte-aiguilles  
Portaghi

MAB11-086 27 cm / 10 3/4"  
Normalprofil  
standard profile  
perfil estándar  
profil normal  
porfilo normale



Wangenstein

Normalprofil  
standard profile  
perfil estándar  
profil normal  
porfilo normale



Mikroprofil  
micro profile  
profil micro  
profilo micro

MAB11-087 14 cm / 5 1/2"  
MAB11-088 18.5 cm / 7 1/4"

MAB11-089 20.5 cm / 8"  
MAB11-090 23 cm / 9"



Hegar-Vascular

MAB11-091 20.5 cm / 8"  
MAB11-092 24 cm / 9 1/2"

MAB11-093 26.5 cm / 10 1/2"  
MAB11-094 29 cm / 11 1/2"



Naht . Suture . Sutura  
Nadelhalter  
Needle Holders  
Porta-agujas  
Porte-aiguilles  
Portaghi

Miniprofil  
elastisches Modell  
mini profile  
elastic type  
perfil mini  
modelo elástico  
profil mini  
modèle souple  
profilo mini  
modello molle

MAB11-076 15 cm / 6"  
MAB11-077 17 cm / 6 1/4"  
MAB11-078 20 cm / 8"



Martin

schlankes Modell  
Mikroprofil  
slender pattern  
mini profile  
modelo delgado  
perfil micro  
modèle gracile  
profil micro  
modello fino  
profilo micro

MAB11-079 12.5 cm / 5"  
MAB11-080 15.5 cm / 6"  
MAB11-081 17.5 cm / 7"

MAB11-082 20 cm / 8"  
MAB11-083 22.5 cm / 8 3/4"  
MAB12-084 26 cm / 10 1/4"

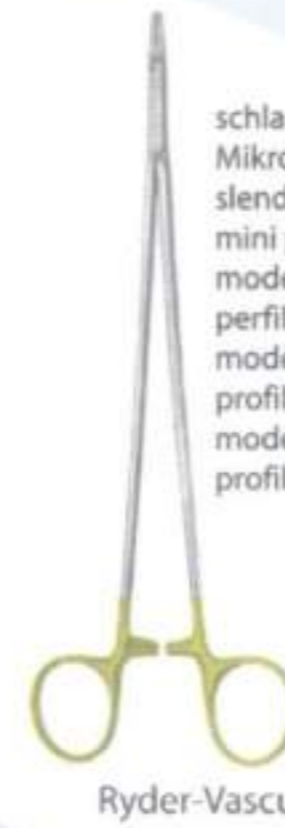

Ryder-Vascular

Naht . Suture . Sutura  
Nadelhalter  
Needle Holders  
Porta-agujas  
Porte-aiguilles  
Portaghi

MAB11-095 20 cm / 8"  
MAB11-096 23.5 cm / 9 1/4"

Normalprofil  
standard profile  
perfil estándar  
profil normal  
porfilo normale



Hegar

schlankes Modell  
Mikroprofil  
slender pattern  
micro profile  
modelo delgado  
perfil micro  
modèle gracile  
profil micro  
modello gracile  
profilo micro

MAB11-099 14 cm / 5 1/2"  
MAB11-100 17.5 cm / 7"

MAB11-101 20 cm / 8"  
MAB11-102 23 cm / 9"



Microvascular

MAB11-097 23 cm / 9"  
MAB11-098 26 cm / 10"

Normalprofil  
standard profile  
perfil estándar  
profil normal  
porfilo normale



Stratte

schlankes Modell  
glattes Maul  
slender pattern  
smooth jaw  
modelo delgado  
boca lisa  
modèle gracile  
mors lisse  
modello gracile  
morso liscio

MAB11-103 14 cm / 5 1/2"  
MAB12-104 16 cm / 6 1/4"

MAB11-105 17.5 cm / 7"  
MAB12-106 20 cm / 8"



Martini

MAB11-085 26 cm / 10 1/2"  
Normalprofil  
standard profile  
perfil estándar  
profil normal  
porfilo normale



Finochietto



Naht . Suture . Sutura  
Nadelhalter  
Needle Holders  
Porta-agujas  
Porte-aiguilles  
Portaghi

schlankes Modell  
Mikroprofil  
slender pattern  
micro profile  
modelo delgado  
perfil micro  
modèle gracile  
profil micro  
modello gracile  
profilo micro



**Martini**

MAB11-107 MAB11-108  
14 cm / 5 1/2" 16 cm / 6 1/4"

MAB11-109 MAB11-110  
17.5 cm / 7" 20 cm / 8"

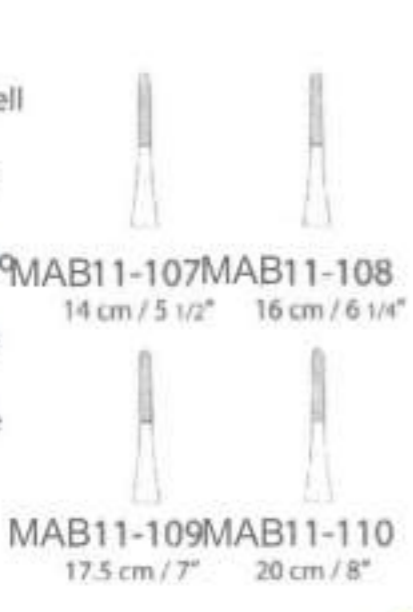

MAB11-111 MAB11-112  
14.5 cm / 5 3/4" 17 cm / 6 3/4"

MAB11-113  
19 cm / 7 1/2"

Normalprofil  
standard profile  
perfil estándar  
profil normal  
porfilo normale



**Olsen-Hegar**

Naht . Suture . Sutura  
Nadelhalter  
Needle Holders  
Porta-agujas  
Porte-aiguilles  
Portaghi

MAB11-117 MAB11-118 MAB11-119  
14 cm / 5 1/2" 17 cm / 6 3/4" 20 cm / 8"

Normalprofil  
standard profile  
perfil estándar  
profil normal  
porfilo normale



**Mathieu**

MAB11-120 MAB11-121 MAB11-122  
14 cm / 5 1/2" 17 cm / 6 3/4" 20 cm / 8"

Normalprofil  
standard profile  
perfil estándar  
profil normal  
porfilo normale



**Mathieu**

MAB11-114  
11 cm / 4 1/4"  
glattes Maul  
smooth jaw  
boca lisa  
mors lisse  
morso liscio



**Foster-Gillies**

MAB11-115  
15 cm / 6"  
Miniprofil  
mini profile  
profil mini  
profilo mini



**Gillies-Mini**

MAB11-116  
16 cm / 6 1/4"  
Normalprofil  
standard profile  
perfil estándar  
profil normal  
porfilo normale



**Gillies**

MAB11-123 MAB11-124 MAB11-125  
17 cm / 6 3/4" 20 cm / 8" 23 cm / 9"

Normalprofil  
mit Innesperre  
standard profile  
with interior ratchet  
profil estándar  
con cremallera interior  
profil cormal  
avec crémaillère interne  
profilo normale  
con cremagliera interna



**Mathieu**

Naht . Suture . Sutura  
Nadelhalter  
Needle Holders  
Porta-agujas  
Porte-aiguilles  
Portaghi

MAB11-126  
18.5 cm / 7 1/4"  
Normalprofil  
standard profile  
perfil estándar  
profil normal  
porfilo normale



**Toennis**

MAB11-127  
20 cm / 8"  
leichtes Modell  
Normalprofil  
lightweight model  
standard profile  
modelo ligero  
profil estándar  
modèle léger  
profil normal  
modello leggero  
profilo normale



**Lichtenberg**

Naht . Suture . Sutura  
Reverdin Nadeln  
Reverdin Needles  
Agujas de Reverdin  
Aguilles de Reverdin  
Aghi di Reverdin

kurz  
short  
corto  
court

Fig.1 Fig.2 Fig.3 Fig.4

MAB11-133 MAB11-134 MAB11-135 MAB11-136  
14.5 cm / 5 3/4" 14.5 cm / 5 3/4" 14.5 cm / 5 3/4" 14.5 cm / 5 3/4"



**Reverdin**

MAB11-128 MAB11-129 MAB11-130  
18 cm / 7" 20.5 cm / 8" 23 cm / 9"

Normalprofil  
standard profile  
perfil estándar  
profil normal  
porfilo normale



**Langenbeck**

MAB11-131 MAB11-132  
20.5 cm / 8" 23 cm / 9"

mit Klappsperr  
Normalprofil  
with hinged ratchet  
standard profile  
con cremallera abatible  
profil estándar  
avec crémaillère repliable  
profil normal  
con cremagliera a scatto  
profilo normale



**Zweifel**

mittel  
medium  
medio  
moyen  
mediano

Fig.1 Fig.2 Fig.3 Fig.4

MAB11-137 MAB11-139 MAB11-141 MAB11-143 MAB11-145  
19.5 cm / 7 3/4" 19.5 cm / 7 3/4" 19.5 cm / 7 3/4" 19.5 cm / 7 3/4" 19.5 cm / 7 3/4"

MAB11-138 MAB11-140 MAB11-142 MAB11-144 MAB11-146  
23 cm / 9" 23 cm / 9" 23 cm / 9" 23 cm / 9" 23 cm / 9"



**Reverdin**

lang  
long  
largo  
long  
lungo



**Naht . Suture . Sutura**  
**Reverdin Nadeln**  
**Reverdin Needles**  
**Agujas de Reverdin**  
**Aguilles de Reverdin**  
**Aghi di Reverdin**

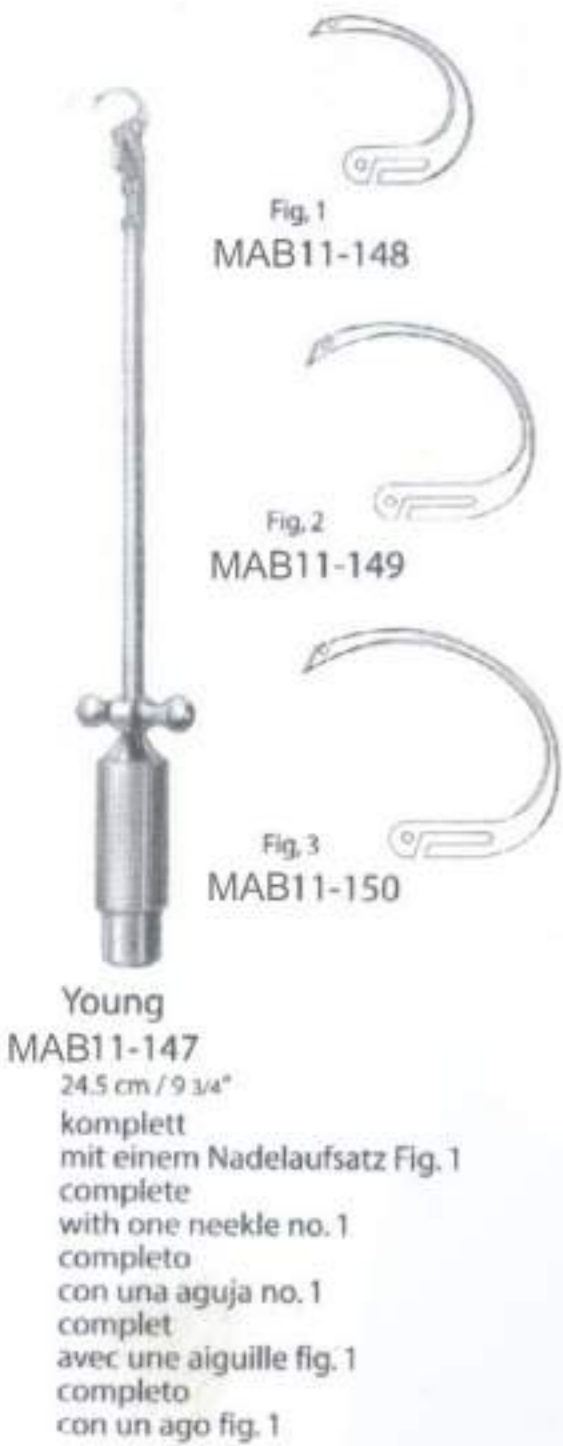

**Fig.1**  
MAB11-148

**Fig.2**  
MAB11-149

**Fig.3**  
MAB11-150

**Young**  
MAB11-147  
24.5 cm / 9 3/4"  
komplett mit einem Nadelaufsatz Fig. 1  
complete with one neekle no. 1  
completo con una aguja no. 1  
complet avec une aiguille fig. 1  
completo con un ago fig. 1



**Schmieden-Dick**  
MAB11-151  
29 cm / 11 1/2"  
biegsam  
malleable  
maleable  
malléable  
malleabile

**Schmieden**  
MAB11-152  
24 cm / 9 1/2"

**Naht . Suture . Sutura**  
**Unterbindungsnadeln**  
**Ligature Needles**  
**Agujas para ligaduras**  
**Aiguilles à ligatures**  
**Aghi per legatura**



**MAB11-153**  
20.5 cm / 8"  
biegsam  
malleable  
maleable  
malléable  
malleabile

**MAB11-154**  
18.5 cm / 7 1/4"  
**Cooper**

**MAB11-155**  
12.5 cm / 5"  
fein  
für die rechte Hand  
delicate  
for right hand  
fina  
para la mano derecha  
fine  
pour la main droite  
fino  
per la mano destra

**MAB11-156**  
12.5 cm / 5"  
fein  
für die linke Hand  
delicate  
for left hand  
fina  
para la mano izquierda  
fine  
pour la main gauche  
fino  
per la mano sinistra

**MAB11-157**  
24 cm / 9 1/2"  
**Deschamps**

**MAB11-158**  
24 cm / 9 1/2"  
**Deschamps**

stumpf für die rechte Hand  
blunt for right hand  
roma para la mano derecha  
mousse pour la main droite  
smusso per la mano destra

stumpf für die linke Hand  
blunt for left hand  
roma para la mano izquierda  
mousse pour la main gauche  
smusso per la mano sinistra

**Naht . Suture . Sutura**  
**Unterbindungsnadeln**  
**Ligature Needles**  
**Agujas para ligaduras**  
**Aiguilles à ligatures**  
**Aghi per legatura**

stumpf für die rechte Hand  
blunt for right hand  
roma para la mano derecha  
mousse pour la main droite  
smusso per la mano destra

scharf für die rechte Hand  
sharp for right hand  
aguda para la mano derecha  
aiguë pour la main droite  
acuto per la mano destra

stumpf für die rechte Hand  
blunt for right hand  
roma para la mano derecha  
mousse pour la main droite  
smusso per la mano destra

stumpf für die linke Hand  
blunt for left hand  
roma para la mano izquierda  
mousse pour la main gauche  
smusso per la mano sinistra

scharf für die linke Hand  
sharp for left hand  
aguda para la mano izquierda  
aiguë pour la main gauche  
acuto per la mano sinistra

stumpf für die linke Hand  
blunt for left hand  
roma para la mano izquierda  
mousse pour la main gauche  
smusso per la mano sinistra

**Naht . Suture . Sutura**  
**Unterbindungsnadeln**  
**Ligature Needles**  
**Agujas para ligaduras**  
**Aiguilles à ligatures**  
**Aghi per legatura**

scharf für die rechte Hand  
sharp for right hand  
aguda para la mano derecha  
aiguë pour la main droite  
acuto per la mano destra

stumpf für die rechte Hand  
blunt for right hand  
roma para la mano derecha  
mousse pour la main droite  
smusso per la mano destra

stumpf für die linke Hand  
blunt for left hand  
roma para la mano izquierda  
mousse pour la main gauche  
smusso per la mano sinistra

scharf für die linke Hand  
sharp for left hand  
aguda para la mano izquierda  
aiguë pour la main gauche  
acuto per la mano sinistra



**MAB11-159** 20 cm / 8"  
**MAB-160** 20 cm / 8"  
**MAB-161** 20 cm / 8"  
**MAB11-162** 20 cm / 8"  
**MAB11-163** 20 cm / 8"  
**MAB11-164** 20 cm / 8"  
**MAB11-165** 20 cm / 8"  
**MAB11-166** 20 cm / 8"  
**MAB11-167** 27 cm / 10 1/2"  
**MAB11-168** 27 cm / 10 1/2"  
**MAB11-169** 27 cm / 10 1/2"  
**MAB11-170** 27 cm / 10 1/2"

**Deschamps** **Deschamps** **Deschamps** **Deschamps** **Deschamps** **Deschamps**



**Naht . Suture . Sutura**  
**Unterbindungsnadeln**  
**Ligature Needles**  
**Agujas para ligaduras**  
**Aiguilles à ligatures**  
**Aghi per legatura**

scharf  
für die rechte Hand  
sharp  
for right hand  
aguda  
para la mano derecha  
aigue  
pour la main droite  
acuto  
per la mano destra

stumpf  
für die rechte Hand  
blunt  
for right hand  
roma  
para la mano derecha  
mousse  
pour la main droite  
smusso  
per la mano destra

scharf  
für die linke Hand  
sharp  
for left hand  
aguda  
para la mano izquierda  
aigue  
pour la main gauche  
acuto  
per la mano sinistra

stumpf  
für die linke Hand  
blunt  
for left hand  
roma  
para la mano izquierda  
mousse  
pour la main gauche  
smusso  
per la mano sinistra

**Naht . Suture . Sutura**  
**Unterbindungsnadeln**  
**Ligature Needles**  
**Agujas para ligaduras**  
**Aiguilles à ligatures**  
**Aghi per legatura**

stumpf  
für die rechte Hand  
blunt  
for right hand  
roma  
para la mano derecha  
mousse  
pour la main droite  
smusso  
per la mano destra

stumpf  
für die linke Hand  
blunt  
for left hand  
roma  
para la mano izquierda  
mousse  
pour la main gauche  
smusso  
per la mano sinistra



**Naht . Suture . Sutura**  
**Führungshohlsonden**  
**Ligature Conductors**  
**Sondas conductoras**  
**Sondes conductrices**  
**Sonde conduttrici**

**Naht . Suture . Sutura**  
**Führungshohlsonden**  
**Ligature Conductors**  
**Sondas conductoras**  
**Sondes conductrices**  
**Sonde conduttrici**

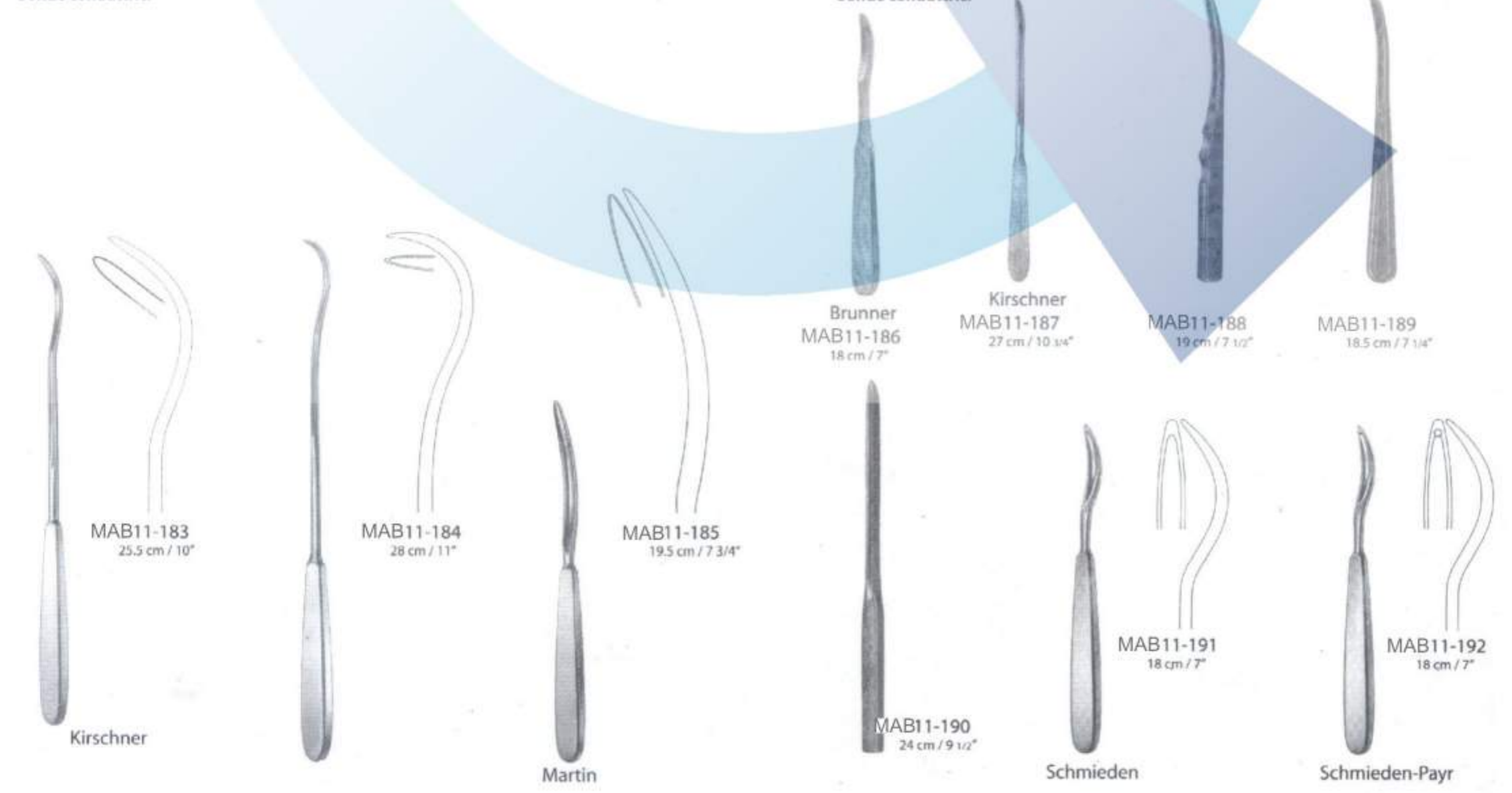



Naht . Suture . Sutura  
Führungshohlsonden  
Ligature Conductors  
Sondas conductoras  
Sondes conductrices  
Sonde conduttrici

Naht . Suture . Sutura  
Wundklammerpinzetten, Wundklammerzängchen  
Clip Applying Forceps  
Pinzas aplicadoras para agrafes  
Pincas à poser les agrafes  
Pinze per applicare le agrafe

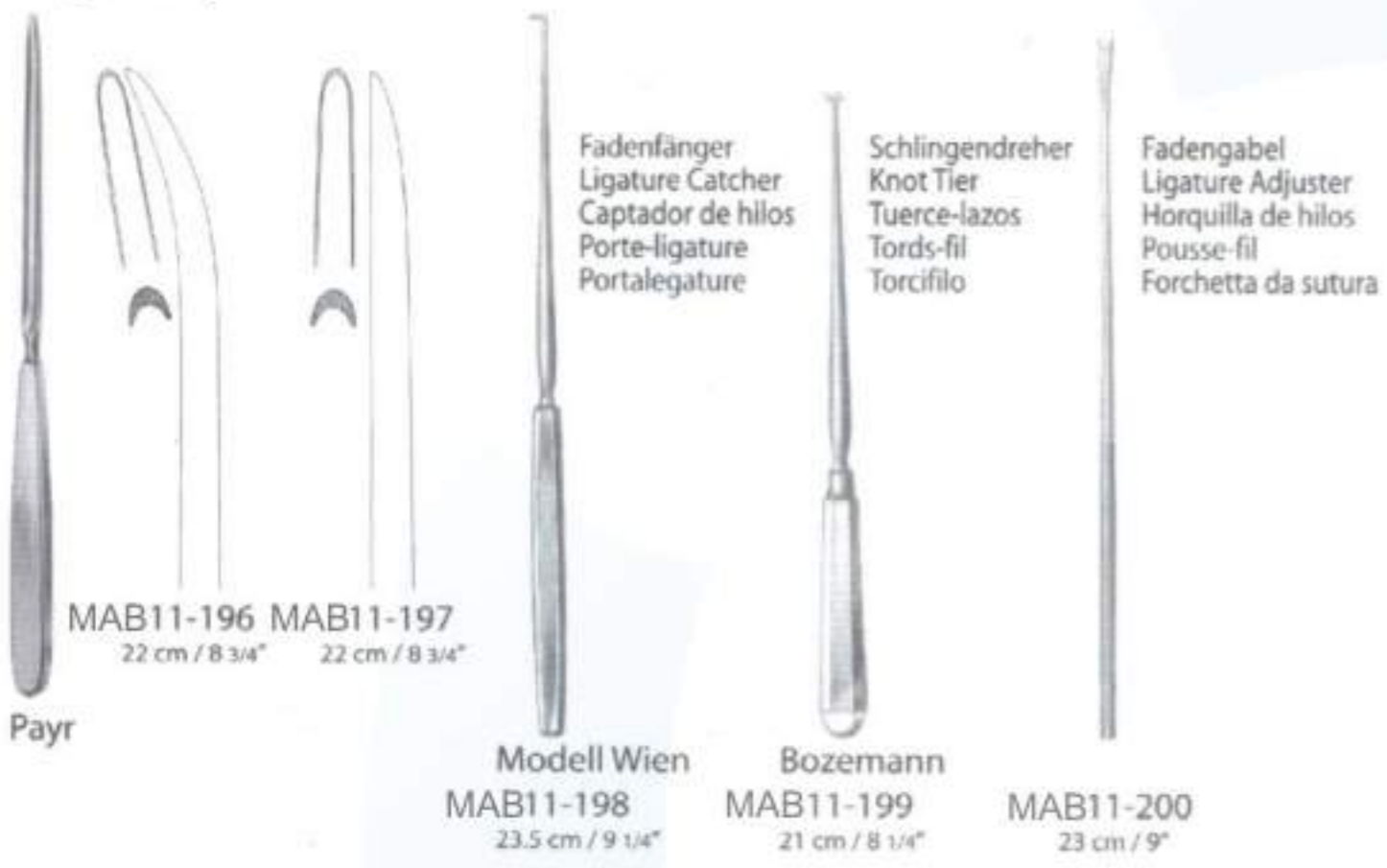

## MAB 12

Verband  
Dressings  
Vendajes  
Pansements  
Bendaggi

Verband . Dressings . Vendajes  
Verbandscheren, Gipsscheren  
Bandage Scissors, Plaster Shears  
Tijeras para vendajes, Tijeras para yeso  
Ciseaux pour pansements, Ciseaux pour plâtre  
Forbici per bendaggi, Forbici per gesso

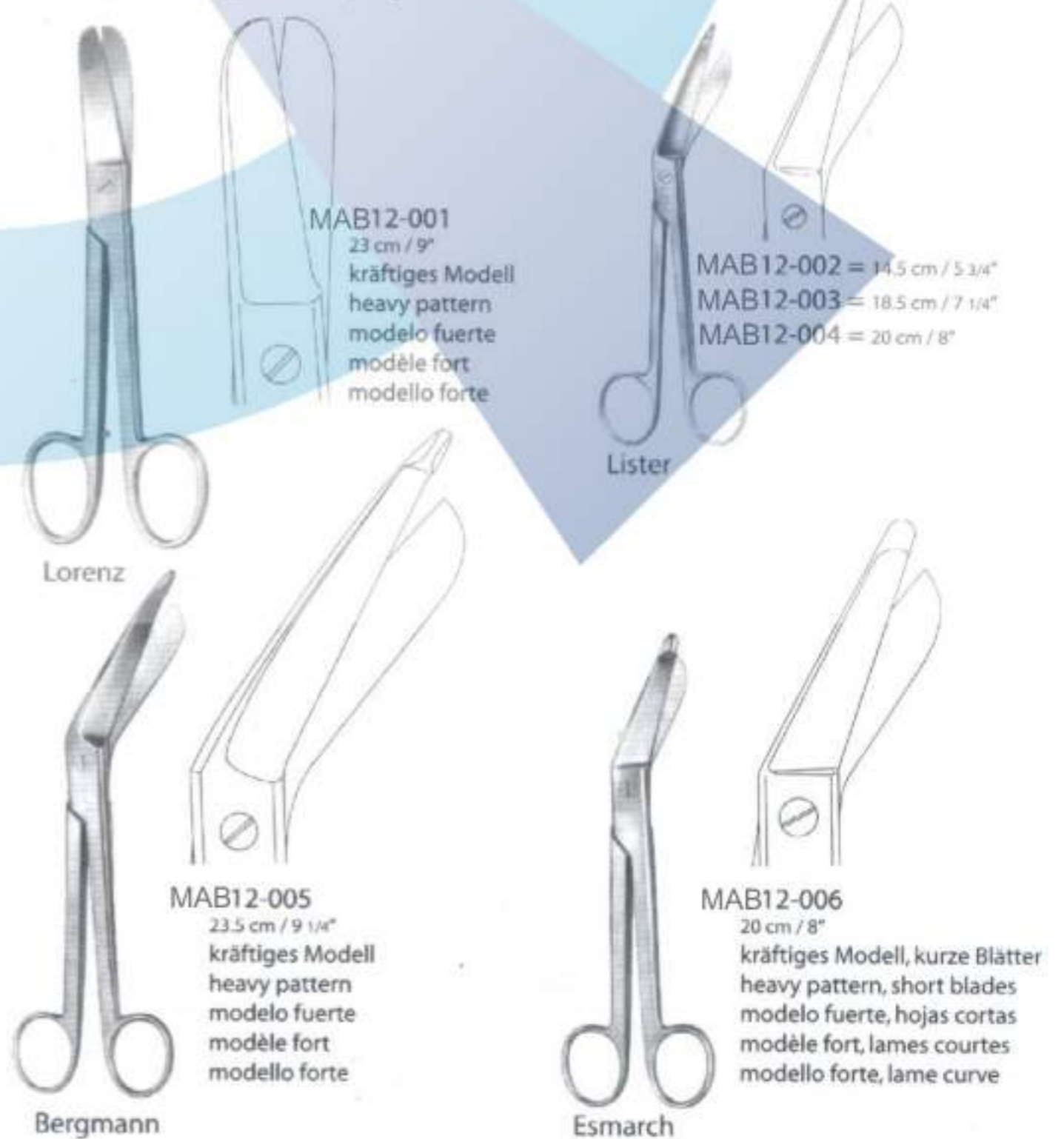



Verband . Pansements . Bendaggi  
 Verbandscheren, Gipsscheren  
 Bandage Scissors, Plaster Scissors  
 Tijeras para vendajes, Tijeras para yeso  
 Ciseaux pour pansements, Ciseaux pour plâtre  
 Forbici per bendaggi, Forbici per gesso



MAB12-007 = 16 cm / 6 1/4"  
 MAB12-008 = 19 cm / 7 1/2"  
 schwarze Kunststoffringe  
 autoklavierbar  
 black plastic rings  
 autoclavable  
 anillos negros, plástico  
 autoclavable  
 avec anneaux en matière plastique noire  
 autoclavable  
 anelli neri di materia plastica  
 sterilizzabile in autoclave

Verband . Dressings . Vendajes  
 Gipsscheren  
 Plaster Shears  
 Cizallas para yeso  
 Ciseaux pour plâtre  
 Forbici per gesso



Stille-Martin



Bruns

MAB12-009  
 24 cm / 9 1/2"  
 eine Schneide gezahnt  
 one serrated cutting edge  
 una hoja cortante dentada  
 une lame dentelée  
 una lama dentata



MAB12-010  
 23 cm / 9"

MAB12-013  
 Ersatzmesser  
 Spare Blade  
 Hoja de recambio  
 Lame de rechange  
 Lama di ricambio



MAB12-011  
 27 cm / 10 1/4"

MAB12-014  
 Ersatzmesser  
 Spare Blade  
 Hoja de recambio  
 Lame de rechange  
 Lama di ricambio



MAB12-012  
 38 cm / 15"

MAB12-015  
 Ersatzmesser  
 Spare Blade  
 Hoja de recambio  
 Lame de rechange  
 Lama di ricambio

Verband . Pansements . Bendaggi  
 Verbandscheren, Gipsscheren  
 Bandage Scissors, Plaster Scissors  
 Tijeras para vendajes, Tijeras para yeso  
 Ciseaux pour pansements, Ciseaux pour plâtre  
 Forbici per bendaggi, Forbici per gesso



Lister

MAB12-016  
 18 cm / 7"

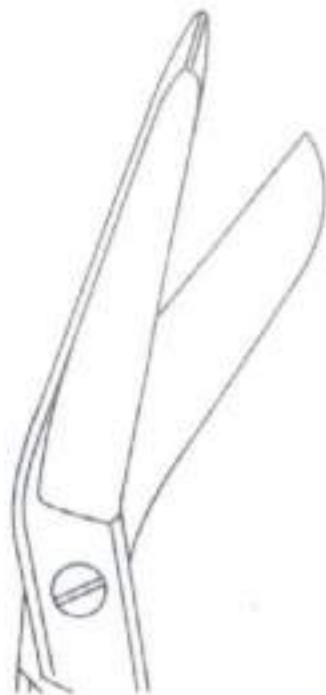

Bruns

MAB12-017  
 24 cm / 9 1/2"



Hopkins  
 MAB12-019  
 20 cm / 8"



Esmarch  
 MAB12-020  
 18 cm / 7"



Reiner  
 MAB12-021  
 18 cm / 7"



Martin  
 MAB12-022  
 21 cm / 8 1/4"

Verband . Dressings . Vendajes  
 Gipsmesser, Gipssäge  
 Plaster Knives, Plaster Saw  
 Cuchillos para yeso, Sierra para yeso  
 Couteaux pour plâtre, Scies pour plâtre  
 Coltelli per gesso, Seghe per gesso



Engel  
 MAB12-018  
 15.5 cm / 6"



Verband . Pansements . Bendaggi  
 Gipsspreizer  
 Plaster Spreaders  
 Separadores para yeso  
 Pincas pour plâtre  
 Pinze per gesso

Verband . Dressings . Vendajes  
 Gipsspreizer, Gipsabreißzangen  
 Plaster Spreaders, Plaster Breakers  
 Separadores para yeso, Pinzas para romper yeso  
 Pincas pour plâtre, Pincas pour rompre plâtre  
 Pinze per gesso, Pinze per rompere gesso

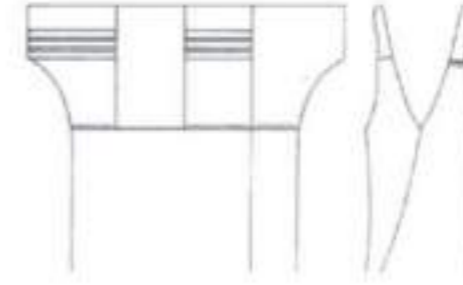
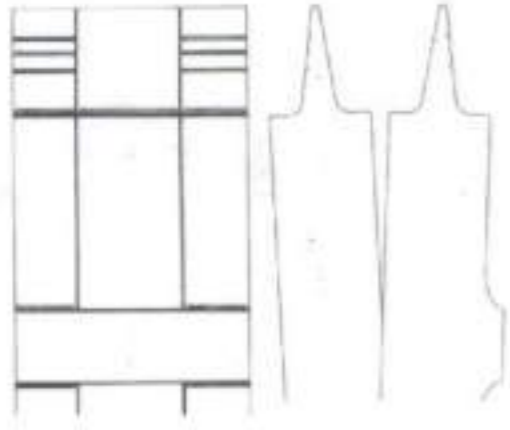

Hermann  
 MAB12-023  
 48 cm / 19"

kräftiges Modell  
 heavy pattern  
 modelo fuerte  
 modèle fort  
 modello forte



Hennig  
 MAB12-024  
 28 cm / 11"



Quattro  
 MAB12-025  
 23 cm / 9"



Wolff



MAB12-026  
 18 cm / 7"



MAB12-027  
 26.5 cm / 10 1/2"

## MAB 13

Knochenchirurgie  
 Bone Surgery  
 Cirugia osea  
 Chirurgie osseuse  
 Chirurgia ossea

Knochenchirurgie . Bone Surgery . Cirugia osea  
 Amputationssägen  
 Amputation Saws  
 Sierras de amputación  
 Scies à amputation  
 Seghe per amputazione

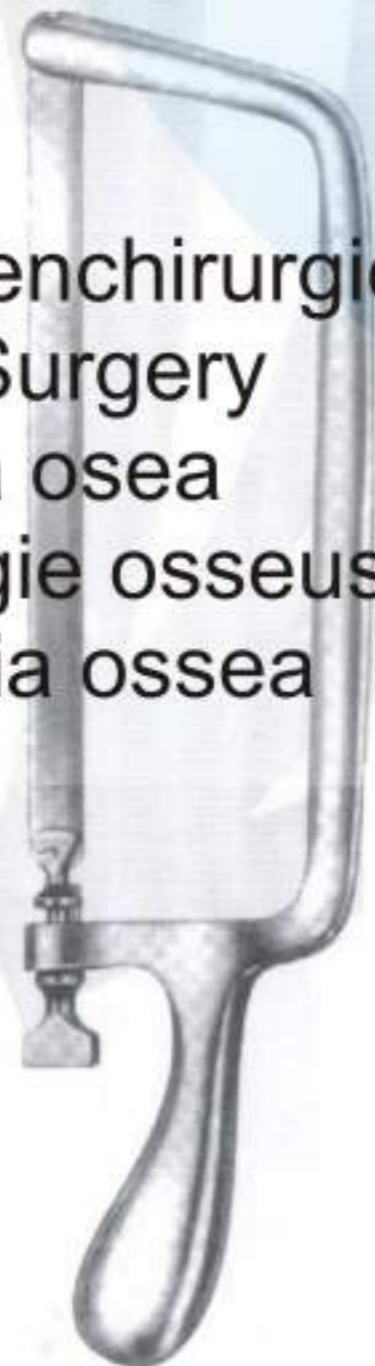

Charrière  
 MAB13-001  
 35 cm / 13 3/4"

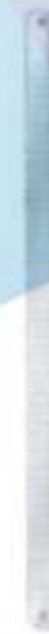

Ersatzsägeblätter  
 Spare Saw Blades  
 Hojas de recambio  
 Lames de rechange  
 Lame di ricambio

breit  
 wide  
 de ancho  
 de largeur  
 larghezza

Charrière  
 MAB13-002 = 12 mm  
 MAB13-003 = 15 mm  
 MAB13-004 = 18 mm



Bier  
 MAB13-005  
 40.5 cm / 16"



Ersatzsägeblätter  
 Spare Saw Blades  
 Hojas de recambio  
 Lames de rechange  
 Lame di ricambio

breit  
 wide  
 de ancho  
 de largeur  
 larghezza

Bier  
 MAB13-006 = 4 mm  
 MAB13-007 = 6 mm  
 MAB13-008 = 8 mm



**Knochenchirurgie . Chirurgie osseuse . Chirurgia ossea**  
**Amputationssägen**  
**Amputation Saws**  
**Sierras de amputación**  
**Scies à amputation**  
**Seghe per amputazione**

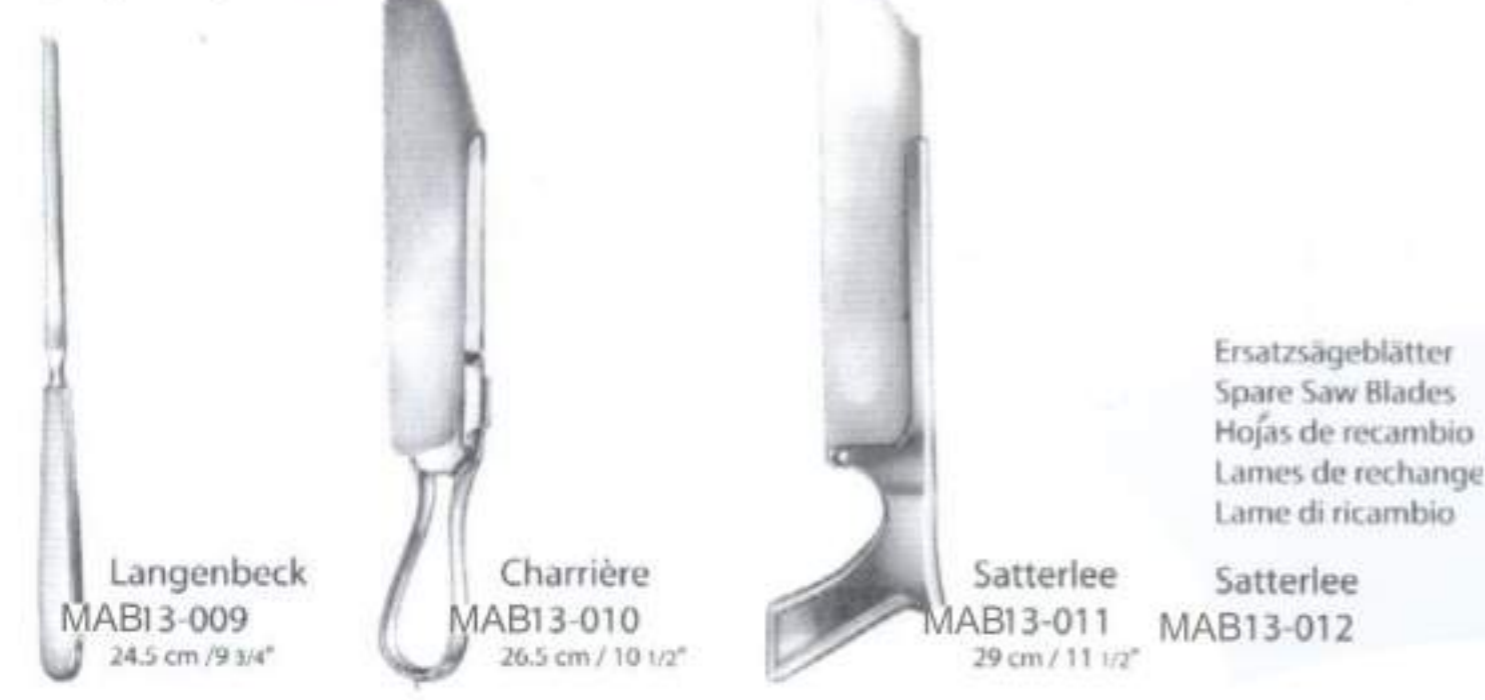

Ersatzsägeblätter  
 Spare Saw Blades  
 Hojas de recambio  
 Lames de rechange  
 Lame di ricambio

**Knochenchirurgie . Chirurgie osseuse . Chirurgia ossea**  
**Handbohrapparate**  
**Hand Drills**  
**Perforadores de mano**  
**Perforateurs à main**  
**Perforatori a mano**



komplett mit drei Bohrern  
 complete with three twist drills  
 completo con tres brocas  
 complet avec trois fraises  
 completo con tre punte

komplett mit neun Bohrern  
 complete with nine twist drills  
 completo con nueve brocas  
 complet avec neuf fraises  
 completo con 9 punte

**Knochenchirurgie . Bone Surgery . Cirugía ósea**  
**Reibahlen**  
**Reamer**  
**Escariadores**  
**Pointes-carrées**  
**Punteruoli**

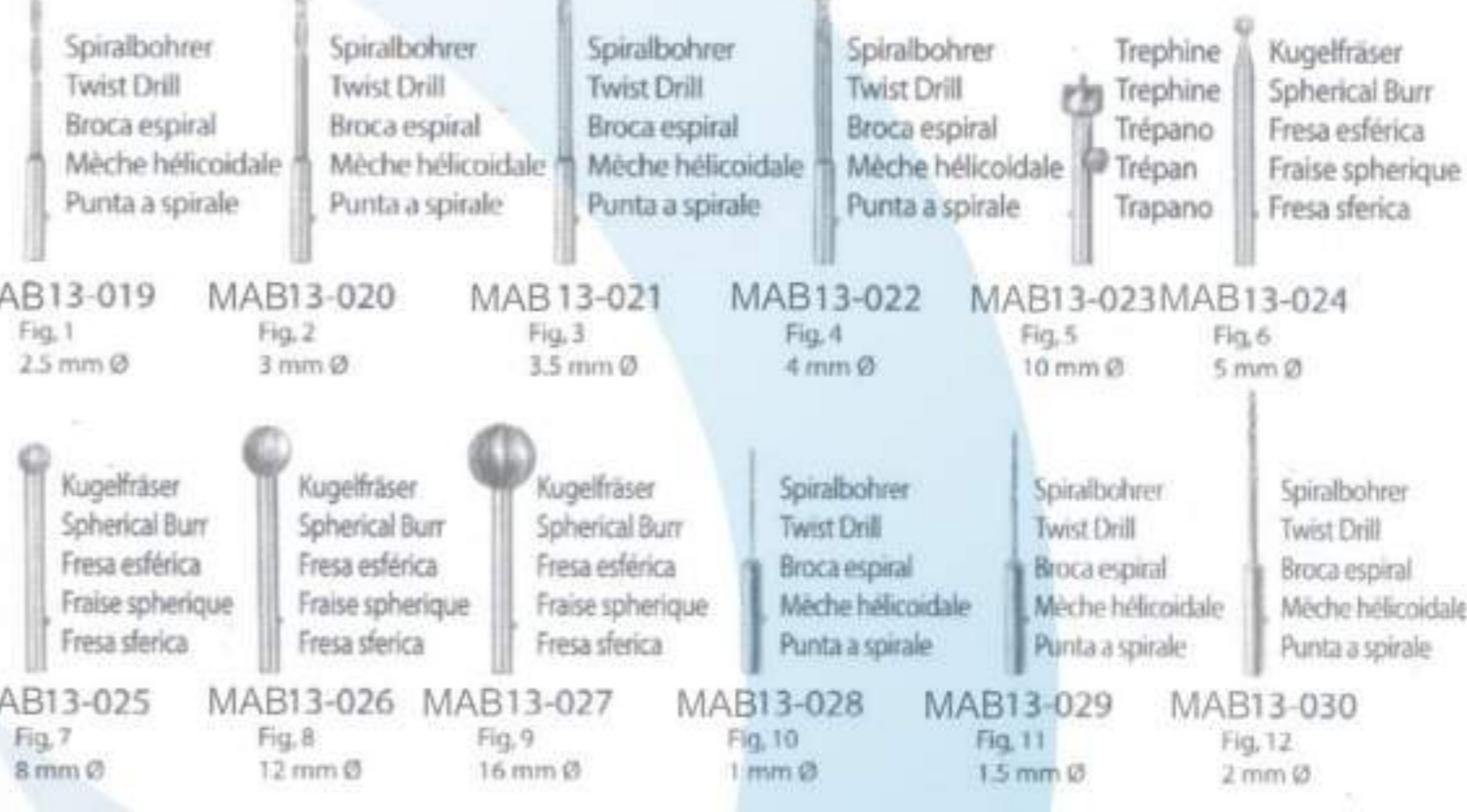

**Knochenchirurgie . Bone Surgery . Cirugía ósea**  
**Handbohrapparate**  
**Hand Drills**  
**Perforadores de mano**  
**Perforateurs à main**  
**Perforatori a mano**



komplett, mit Fräsern Fig. 1-4  
 und Verlängerungsstück  
 complete, with burrs no. 1-4  
 and extension piece  
 completo, con fresas no. 1-4  
 y pieza de extensión  
 complet, avec fraises no. 1-4  
 et pièce de rallonge  
 completo, con fresa fig. 1-4  
 e giunto di prolungamento

**Knochenchirurgie . Chirurgie osseuse . Chirurgia ossea**  
**Handbohrapparate**  
**Hand Drills**  
**Perforadores de mano**  
**Perforateurs à main**  
**Perforatori a mano**

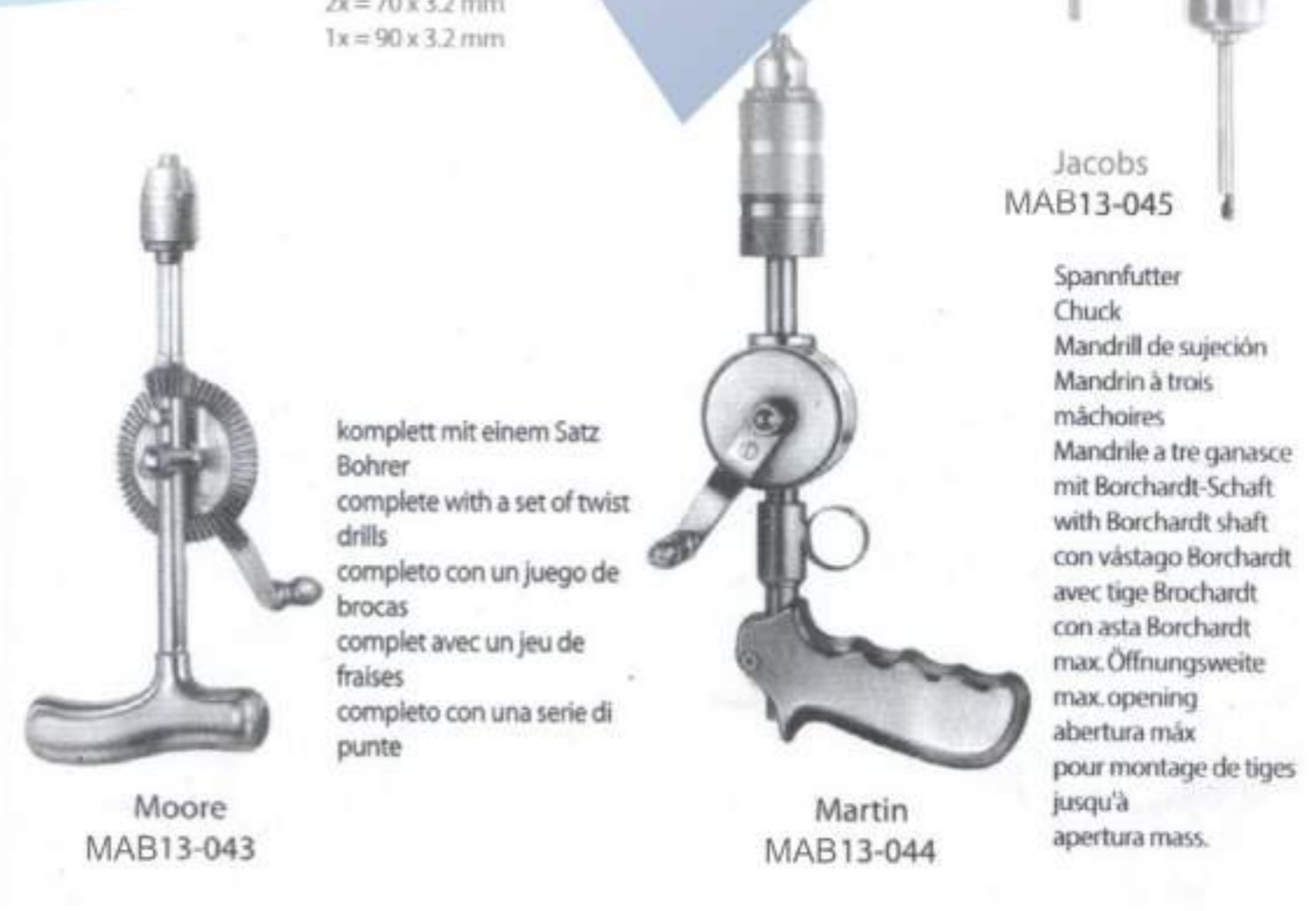

komplett mit einem Satz  
 Bohrer  
 complete with a set of twist  
 drills  
 completo con un juego de  
 brocas  
 complet avec un jeu de  
 fraises  
 completo con una serie di  
 punte

Spannfutter  
 Chuck  
 Mandrill de sujeción  
 Mandrin à trois  
 mâchoires  
 Mandrile a tre ganasce  
 mit Borchardt-Schaft  
 with Borchardt shaft  
 con vástago Borchardt  
 avec tige Brochard  
 con asta Borchardt  
 max. Öffnungsweite  
 max. opening  
 abertura máx  
 pour montage de tiges  
 jusqu'à  
 apertura máx.



**Knochenchirurgie . Bone Surgery . Cirugía ósea**  
**Spiralbohrer**  
**Twist Drills**  
**Brocas espirales**  
**Mèches hélicoïdales**  
**Punte a spirale**

**Knochenchirurgie . Chirurgie osseuse . Chirurgia ossea**  
**Kugelfräser, Fräser, Spiralbohrer**  
**Spherical Burrs, Burrs, Twist Drills**  
**Taladro esférico, Taladros, Brocas espirales**  
**Trépan spherique, Fraises, Mèches hélicoïdales**  
**Frese sferiche, Frese, Punte a spirale**



1,0 mm Ø	MAB13-055		
1,2 mm Ø	MAB13-056		
1,5 mm Ø	MAB13-057		
1,8 mm Ø	MAB13-058	MAB13-068	
2,0 mm Ø	MAB13-046	MAB13-059	MAB13-069
2,2 mm Ø		MAB13-060	MAB13-070
2,5 mm Ø	MAB13-047	MAB13-061	MAB13-071
2,8 mm Ø		MAB13-062	
3,0 mm Ø	MAB13-048	MAB13-063	MAB13-072
3,2 mm Ø	MAB13-049	MAB13-064	
3,5 mm Ø	MAB13-050	MAB13-065	MAB13-073
4,0 mm Ø	MAB13-051	MAB13-066	MAB13-074
5,0 mm Ø	MAB13-052	MAB13-067	MAB13-075
6,0 mm Ø	MAB13-053		
7,0 mm Ø	MAB13-054		

1,0 mm ø		1,0 mm ø	MAB13-080
1,5 mm ø		1,5 mm ø	MAB13-081
2,0 mm ø		2,0 mm ø	MAB13-082
2,5 mm ø		2,5 mm ø	MAB13-083
2,8 mm ø		2,8 mm ø	MAB13-084
3,0 mm ø		3,0 mm ø	MAB13-085
3,2 mm ø		3,2 mm ø	MAB13-086
3,5 mm ø		3,5 mm ø	MAB13-087
4,0 mm ø	MAB13-076	MAB13-078	4,0 mm ø MAB13-088
4,5 mm ø	MAB13-077		4,5 mm ø MAB13-089
5,0 mm ø		MAB13-079	5,0 mm ø MAB13-090
6,0 mm ø			6,0 mm ø MAB13-091

**Knochenchirurgie . Bone Surgery . Cirugía ósea**  
**Kugelfräser, Fräser**  
**Spherical Burrs, Burrs**  
**Taladros esféricos, Taladros**  
**Fraises sphériques, Fraises**  
**Frese sferiche, Frese**

**Knochenchirurgie . Chirurgie osseuse . Chirurgia ossea**  
**Fräser, Spitzfräser, Flachfräser, Trephine**  
**Burrs, Pointed Cutter, Flat Burr, Trephine**  
**Taladros, Taladro agudo, Taladro plano, Trépano**  
**Fraises, Fraises pointues, Fraise plate, Trépan**  
**Frese, Frese appuntate, Frese piatti, Trapani**

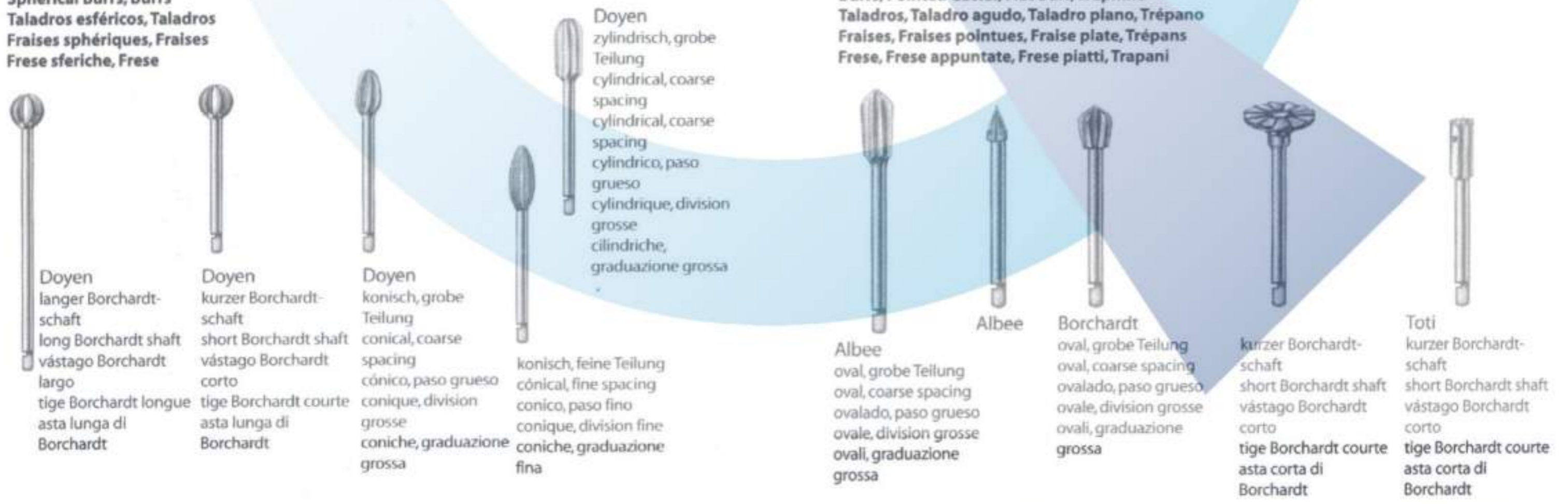

4,0 mm ø	MAB13-092	MAB13-099		
6,0 mm ø	MAB13-093	MAB13-100		
7,0 mm ø				
8,0 mm ø	MAB13-094	MAB13-101	MAB13-107	
10,0 mm ø	MAB13-095	MAB13-102	MAB13-108	
12,0 mm ø	MAB13-096	MAB13-103	MAB13-106	MAB13-109
13,0 mm ø				
14,0 mm ø	MAB13-097	MAB13-104		
15,0 mm ø			MAB13-110	
16,0 mm ø	MAB13-098	MAB13-105		
25,0 mm ø				

4,0 mm ø		
6,0 mm ø	MAB13-114	
7,0 mm ø		
8,0 mm ø	MAB13-111	MAB13-117
10,0 mm ø	MAB13-112	
12,0 mm ø	MAB13-113	MAB13-115
13,0 mm ø		
14,0 mm ø		
15,0 mm ø		
16,0 mm ø		
25,0 mm ø		MAB13-116



Knochenchirurgie . Bone Surgery . Cirugía ósea  
 Knochenhalteklammern, Distractionsklammer  
 Bone Holding Clamps, Traction Bar  
 Grapas porta-huesos, Barra de tracción  
 Daviers à os, Ecarteurs pour les daviers à os  
 Tenaglia per ossa, Divaricatore per le tenaglia per ossa

Knochenchirurgie . Chirurgie osseuse . Chirurgia ossea  
 Drahtzwirbelzangen  
 Wire Twisting Forceps  
 Pinzas para torcer alambre  
 Pinces à torsader le fil  
 Pinze per ritorcere fili  
**TC GOLD** ritorcere fili

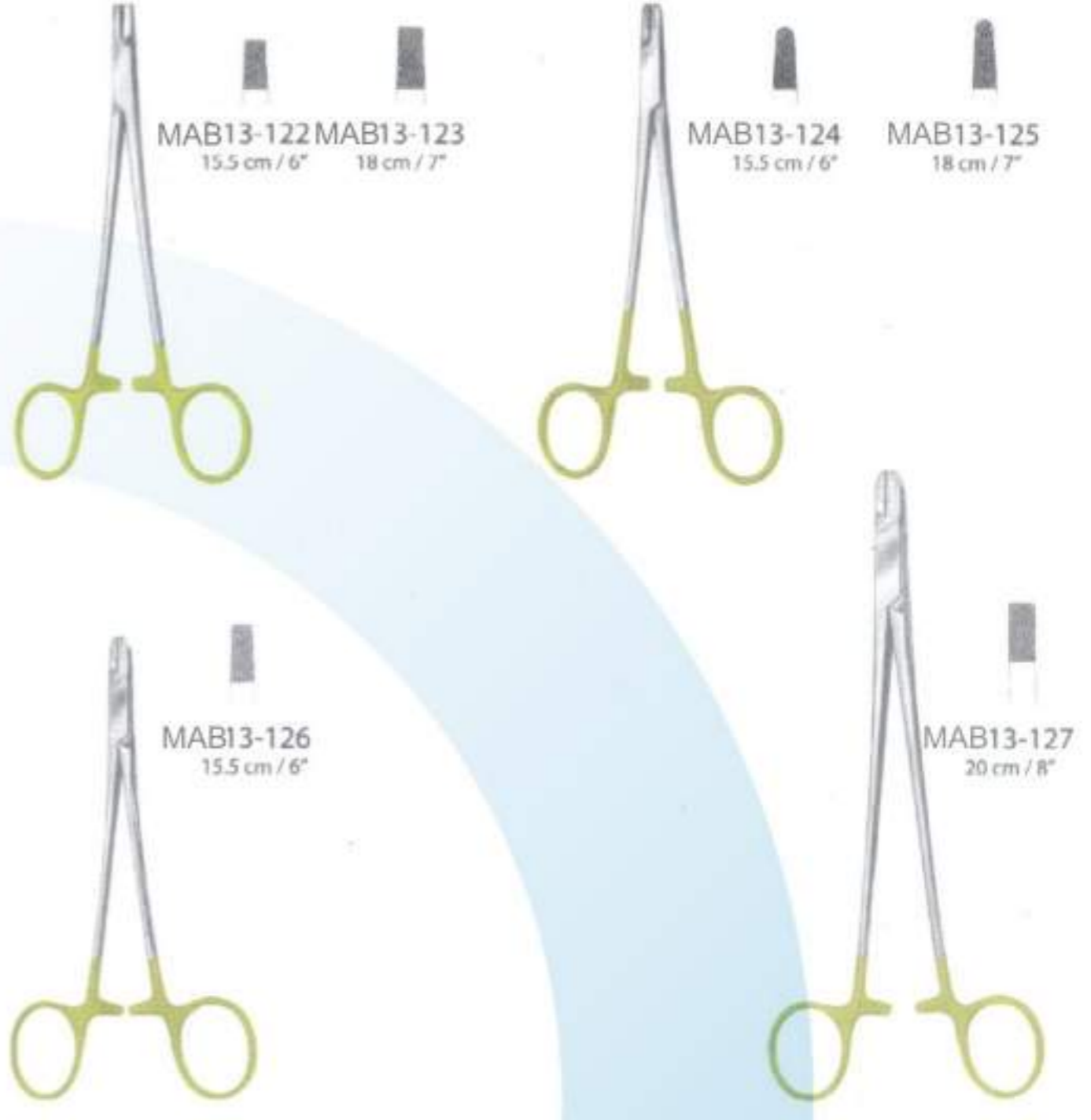

Knochenchirurgie . Bone Surgery . Cirugía ósea  
 Drahtzwirbelzangen  
 Wire Twisting Forceps  
 Pinzas para torcer alambre  
 Pinces à torsader le fil  
 Pinze per ritorcere fili  
**TC GOLD**

Knochenchirurgie . Chirurgie osseuse . Chirurgia ossea  
 Flachzangen, Tonnenzange, Kombinationszange  
 Flat Nose Pliers, Vise Grip, Combi-Flat Nose Plier  
 Alicates de pico plano, Combi-Alicates de alambre  
 Pinces plates, Combi-Pince pour fils  
 Tenaglie piatte, Combi-Pinza per fili

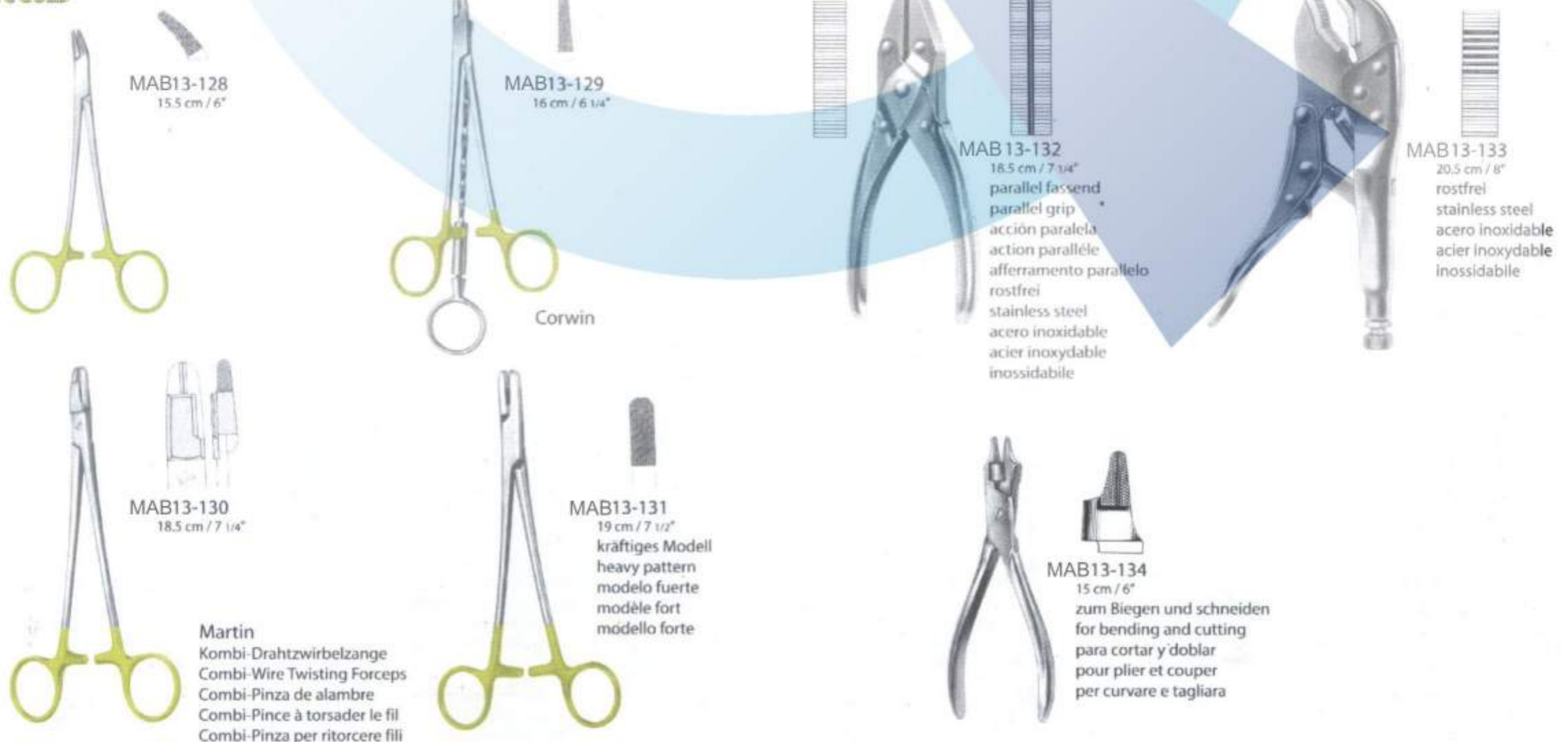



Knochenchirurgie . Bone Surgery . Cirugía ósea  
 Kombinationszange, Flachzangen  
 Combi-Flat Nose Plier, Flat Nose Pliers  
 Combi-Alicates de alambre, Alicates de pico plano  
 Combi-Pince pour fils, Pincas plates  
 Combi-Pinza per fili, Tenaglie piatte

**TC GOLD**



MAB13-135 18 cm / 7"  
 MAB13-136 18 cm / 7"  
 MAB13-137 18 cm / 7"

parallel fassend  
 parallel grip  
 acción paralela  
 action parallèle  
 afferramento parallelo



MAB13-138 13.5 cm / 5 1/4"

knochenchirurgie . chirurgie osseuse . Chirurgia ossea  
 Flachzangen  
 Flat Nose Pliers  
 Alicates de pico plano  
 Pincas plates  
 Tenaglie piatte



MAB13-143 16 cm / 6 1/4"  
 mit Längsrille  
 with longitudinal groove  
 con ranura longitudinal  
 avec rainure longitudinale



MAB13-144 17.5 cm / 7"



MAB13-145 17 cm / 6 3/4"  
 mit Kreuzrille  
 with crosswise groove  
 con ranura en forma de cruz  
 avec rainures croisées  
 con scannelatura a croce

MAB13-139 18 cm / 7"  
 MAB13-140 18 cm / 7"  
 MAB13-141 18 cm / 7"



parallel fassend  
 parallel grip  
 acción paralela  
 action parallèle  
 afferramento parallelo



MAB13-142 18 cm / 7"

Hackstock



MAB13-146 19.5 cm / 7 3/4"

Spitz-und Flachzange  
 Flat Nose Plier, pointed  
 Alicates planos/agudos  
 Pincas plates / aiguës  
 Tenaglie piatte/appuntate

Knochenchirurgie . Bone Surgery . Cirugía ósea  
 Drahtkneifzangen, Seitenschneider  
 Wire Cutting Pliers  
 Alicates para cortar alambre, Tenazas de corte lateral  
 Pincas à couper le fil, Pincas coupantes de côté  
 Tenaglie tagliafil, Tenaglie tagliafilii laterali



für weiche Drähte bis  
 for soft wires up to  
 para alambres blandos hasta  
 pour fils mous jusqu'à  
 per fili molli fino a  
**2,4 mm Ø**  
 für harte Drähte bis  
 for hard wires up to  
 para alambres duros hasta  
 pour fils durs jusqu'à  
 per fili metallici duri fino a  
**1,8 mm Ø**

MAB13-147 18.5 cm / 7 1/4"

**TC GOLD**



Martin "Diamant"  
 MAB13-148 16 cm / 6 1/4"

für weiche Drähte bis  
 for soft wires up to  
 para alambres blandos hasta  
 pour fils mous jusqu'à  
 per fili molli fino a  
**2,2 mm Ø**  
 für harte Drähte bis  
 for hard wires up to  
 para alambres duros hasta  
 pour fils durs jusqu'à  
 per fili metallici duri fino a  
**2,0 mm Ø**

Kopfschneider  
 Wire Cutter, front action  
 Alicates frontal para cortar alambre  
 Pincas coupantes frontales  
 Tenaglie tagliafilii frontali

Knochenchirurgie . Chirurgie osseuse . Chirurgia ossea  
 Seitenschneider, Drahtkneifzangen  
 Wire Cutting Pliers  
 Tenazas de corte lateral, Alicates para cortar alambre  
 Pincas coupantes de côté, Pincas à couper le fil  
 Tenaglie tagliafilii laterali, Tenaglie tagliafilii



MAB13-151 17 cm / 6 3/4"

für weiche Drähte bis  
 for soft wires up to  
 para alambres blandos hasta  
 pour fils mous jusqu'à  
 per fili molli fino a  
**2,0 mm Ø**  
 für harte Drähte bis  
 for hard wires up to  
 para alambres duros hasta  
 pour fils durs jusqu'à  
 per fili metallici duri fino a  
**1,7 mm Ø**

**TC GOLD**



MAB13-152 22.5 cm / 8 3/4"

für weiche Drähte bis  
 for soft wires up to  
 para alambres blandos hasta  
 pour fils mous jusqu'à  
 per fili molli fino a  
**2,8 mm Ø**  
 für harte Drähte bis  
 for hard wires up to  
 para alambres duros hasta  
 pour fils durs jusqu'à  
 per fili metallici duri fino a  
**2,2 mm Ø**



Martin "Gigant-Compact"  
 MAB13-149 17.5 cm / 7"

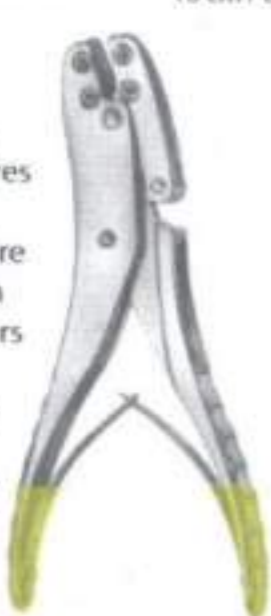

Martin "Gigant-Compact"  
 MAB13-150 17 cm / 9"

für harte Drähte bis  
 for hard wires up to  
 para alambre duros hasta  
 pour fils durs jusqu'à  
 per fili duri fino a  
**3,0 mm Ø**

Ersatzteil-Set  
 komplett mit 2 Ersatzschneiden,  
 Schrauben und Inbusschlüssel  
 Spare parts, set  
 complete with 2 spare inserts,  
 screws and hexagonal key  
 Piezas de repuesto, juego  
 completo con 2 placitas, tornillos  
 y llave hexagonal  
 Pièces de rechange, jeu  
 complet avec deux plaques de  
 rechange, vis clé hexagonale  
 Set di pezzi di ricambio  
 completo con 2 parti taglianti di  
 ricambio, viti e chiave per viti ad  
 esagono incassato e chiave per  
 viti ad esagono incassato



MAB13-153 15 cm / 6"

für weiche Drähte bis  
 for soft wires up to  
 para alambres blandos hasta  
 pour fils mous jusqu'à  
 per fili molli fino a  
**2,0 mm Ø**  
 für harte Drähte bis  
 for hard wires up to  
 para alambres duros hasta  
 pour fils durs jusqu'à  
 per fili metallici duri fino a  
**1,2 mm Ø**

kopf-und seitenschneider  
 Wire Cutting Plier  
 Alicates para cortar alambre  
 Pince pour couper le fil  
 Tenaglia tagliafilii



MAB13-154 17.5 cm / 7"

für weiche Drähte bis  
 for soft wires up to  
 para alambres blandos hasta  
 pour fils mous jusqu'à  
 per fili molli fino a  
**2,0 mm Ø**  
 für harte Drähte bis  
 for hard wires up to  
 para alambres duros hasta  
 pour fils durs jusqu'à  
 per fili metallici duri fino a  
**1,5 mm Ø**



**Knochenchirurgie . Bone Surgery . Cirugía ósea**  
**Stahldraht, Drahtumführungsnaedeln, Drahtspanner**  
**Bone Wire, Wire Guides, Wire Tightener**  
**Alambre para hueso, Agujas pasa-hilo, Tensor cierra-hilo**  
**Fil à os , Aiguilles passe-fils, Tendeur serre-fil**  
**Filo per ossa, Aghi passafili, Strumento tendifili**

**Knochenchirurgie . Chirurgie osseuse . Chirurgia ossea**  
**Extensionsnägel, Extensionsbügel**  
**Extension Pins, Extension Bows**  
**Clavos de extensión, Estribos para extensión**  
**Clous à os, Etriers à extension**  
**Chiodi per ossa, Archi per estensione**



weich, Rolle mit 10 m  
 soft, coil of 10 m  
 blando, rollo de 10 m  
 malléable, en rouleaux de 10 m  
 malleabile, rotolo di 10 m

- MAB13-155 = 0,2 mm ø
- MAB13-156 = 0,3 mm ø
- MAB13-157 = 0,4 mm ø
- MAB13-158 = 0,5 mm ø
- MAB13-159 = 0,6 mm ø
- MAB13-160 = 0,7 mm ø
- MAB13-161 = 0,8 mm ø
- MAB13-162 = 0,9 mm ø
- MAB13-163 = 1,0 mm ø
- MAB13-164 = 1,2 mm ø
- MAB13-165 = 1,5 mm ø

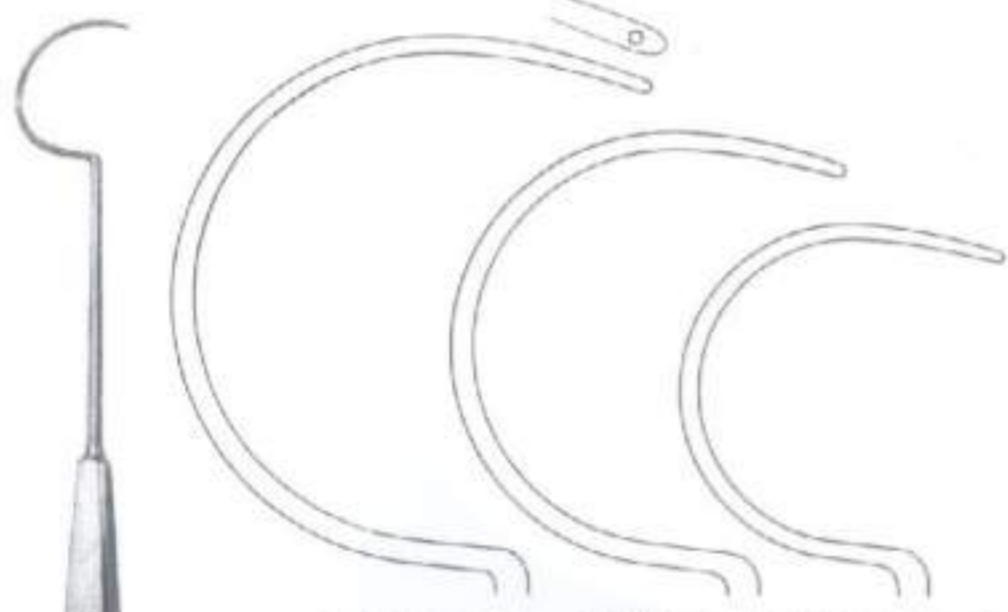

MAB13-166 Fig.1 31 cm / 12 1/4"  
 MAB13-167 Fig.2 29 cm / 11 1/2"  
 MAB13-168 Fig.2 28 cm / 11"

Demel



Loute  
 MAB13-169  
 21 cm / 8 1/4"



Steinmann  
 mit Trokarspitze  
 with trocar point  
 con punta de trocar  
 avec pointe de trocart  
 con punta di trequarti

- MAB13-170 = 14 cm / 5 1/2"
- MAB13-171 = 16 cm / 6 1/4"
- MAB13-172 = 18 cm / 7"
- MAB13-173 = 20 cm / 8"

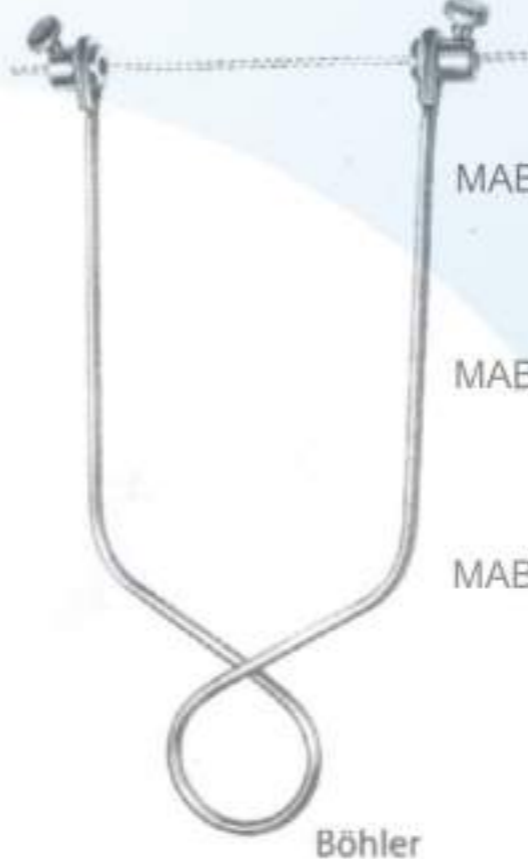

Böhler

- MAB13-174 210 x 150 mm  
8" x 6" für Oberschenkel und Knie  
for femur and knee  
para fémur y rodilla  
pour fémur et genou  
per il femore ed il ginocchio
- MAB13-175 160 x 90 mm  
6 1/4" x 4 1/2" für Arm  
for arm  
para brazo  
pour bras  
per il braccio
- MAB13-176 210 x 110 mm  
8 1/4" x 4 1/2" für Oberschenkel und Knie  
for femur and knee  
para fémur y rodilla  
pour fémur et genou  
per il femore ed il ginocchio

**Knochenchirurgie . Bone Surgery . Cirugía ósea**  
**Extensionsbügel**  
**Extension Bows**  
**Estribos para extensión**  
**Etriers à extension**  
**Archi per estensione**

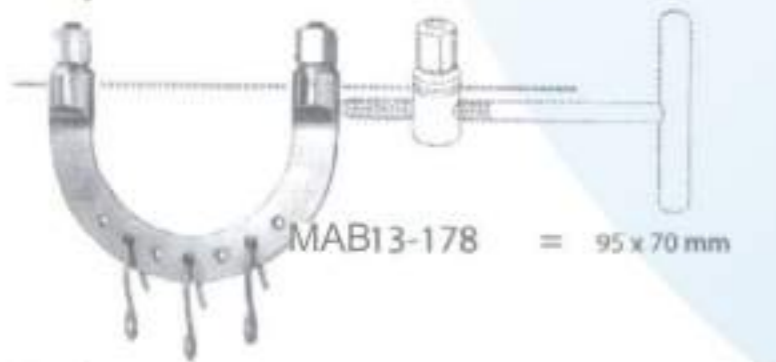

MAB13-178 = 95 x 70 mm

lichte Weite  
 inner width  
 vano  
 largeur ouverte  
 larghezza aperta

für Kinder  
 for children  
 para niños  
 pour enfants  
 per bambini  
 für Hand- und Fußgelenk  
 for wrist and ankle  
 para muñeco y tobillo  
 pour poignet et articulation  
 du pied  
 per polso e piede  
 für Ellenbogen  
 for elbow  
 para codo  
 pour coude  
 per il gomito  
 für Knie  
 for knee  
 para rodilla  
 pour genou  
 per il ginocchio  
 für Oberschenkel  
 for femur  
 para fémur  
 pour fémur  
 per il femore



MAB13-177  
 18,5 cm / 7 1/4"  
 zu  
 for  
 para  
 pour  
 per

**Knochenchirurgie . Chirurgie osseuse . Chirurgia ossea**  
**Extensionsbügel, Fingerextensionshülsen**  
**Extension Bows, Extension Sleeves**  
**Estribos para extensión, Vainas de extensión**  
**Etriers à extension, Douille à extension**  
**Archi per estensione, Boccola di estensione**

Kirschner  
 mit 3 Zughaken  
 with 3 traction hooks  
 con 3 ganchos de tracción  
 avec 3 crochets de traction  
 con 3 ganci di trazione

MAB13-179 = 105 x 105 mm

MAB13-180 = 120 x 120 mm

MAB13-181 = 155 x 155 mm

MAB13-182 = 200 x 155 mm



Kirschner  
 mit 3 Zughaken  
 with 3 traction hooks  
 con 3 ganchos de tracción  
 avec 3 crochets de traction  
 con 3 ganci di trazione

MAB13-184  
 26,5 cm / 10 1/2"

MAB13-183  
 18,5 cm / 7 1/4"

kleines Modell  
 small pattern  
 modelo pequeño  
 modèle petit  
 modello piccolo  
 großes Modell  
 large pattern  
 modelo largo  
 modèle grand  
 modello grande

Spannschlüssel  
 Wire Strainer  
 Tensor de taladros  
 filiformes  
 Tendeur de broches  
 Chiave per mandrino



MAB13-185  
 20 cm / 8"



MAB13-186

lichte Weite  
 inner width  
 vano  
 largeur ouverte  
 larghezza aperta

MAB13-187  
 270 x 160 mm  
 10 1/2" x 6 1/4"



MAB13-188  
 Zughaken für Extensionsbügel  
 Traction Hook for Extension Bows  
 Gancho de tracción para estribos  
 Crochet de traction pour étriers  
 Gancio di trazione



## MAB 14

Knochenmeißel  
Bone Chisels  
Cinceles  
Ciseaux-burins  
Scalpelli



Knochenchirurgie . Bone Surgery . Cirugía ósea  
Flachmeißel, Hohlmeißel  
Chisels, Gouges  
Cinceles, Gubias  
Ciseaux-burins, Gouges  
Scalpelli, Sgorbie

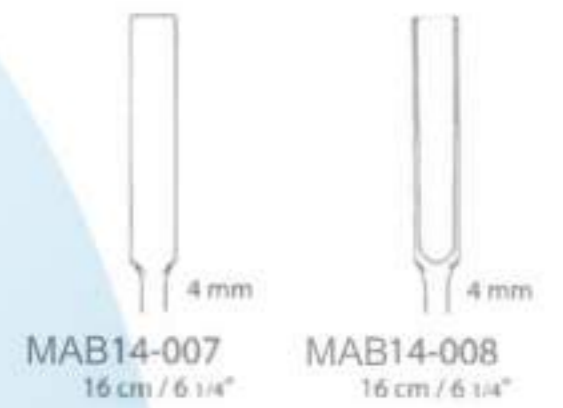
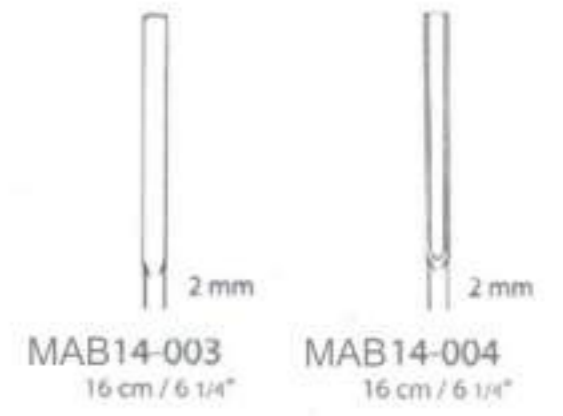

Virchow  
MAB14-001  
Schädelspalter  
Skull Breaker  
Cinzel rompe-cráneo  
Burin pour le crâne  
Scalpello per cranio



Buckley  
MAB14-002  
8-Kant Griff  
octagonal handle  
mango octagonal  
manche octogonale  
manico ottagonale

Knochenchirurgie . Chirurgie osseuse . Chirurgia ossea  
Knochenmeißel  
Bone Chisels  
Cinceles  
Ciseaux-burins  
Scalpelli

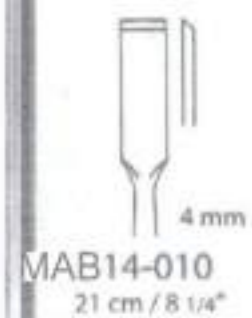

Stout  
8-Kant Griff  
octagonal handle  
mango octagonal  
manche octogonale  
manico ottagonale



8-Kant Griff  
octagonal handle  
mango octagonal  
manche octogonale  
manico ottagonale



8-Kant Griff  
octagonal handle  
mango octagonal  
manche octogonale  
manico ottagonale



8-Kant Griff  
octagonal handle  
mango octagonal  
manche octogonale  
manico ottagonale



8-Kant Griff  
octagonal handle  
mango octagonal  
manche octogonale  
manico ottagonale

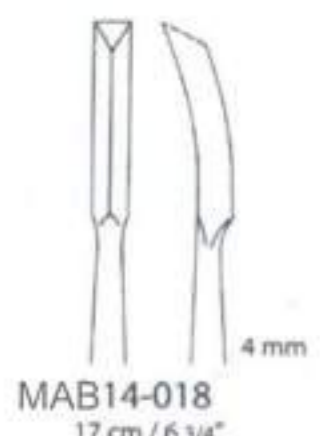
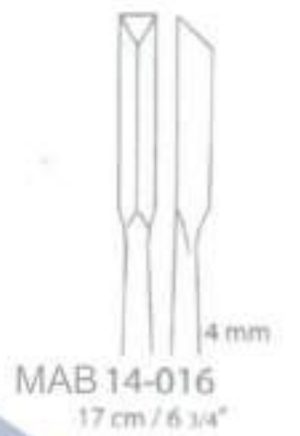

Gardner  
dreieckige Form  
triangular shape  
forma triangulada  
forme triangulaire  
forma triangolare



Knochenchirurgie . Chirurgie osseuse . Chirurgia osseas  
 Hohlmeißel, Knochenmeißel, Osteotome  
 Gouges, Bone Chisels, Osteotomes  
 Gubias, Cinceles, Osteótomos  
 Gouges, Ciseaux-burins, Osteótomos  
 Sgorbie, Scalpelli, Osteotomi

Knochenchirurgie . Bone Surgery . Cirugía ósea  
 Osteotome, Flachmeißel, Hohlmeißel  
 Osteotomes, Chisels, Gouges  
 Osteótomos, Cinceles, Gubias  
 Osteótomos, Ciseaux-burins, Gouges  
 Osteotomi, Scalpelli, Sgorbie

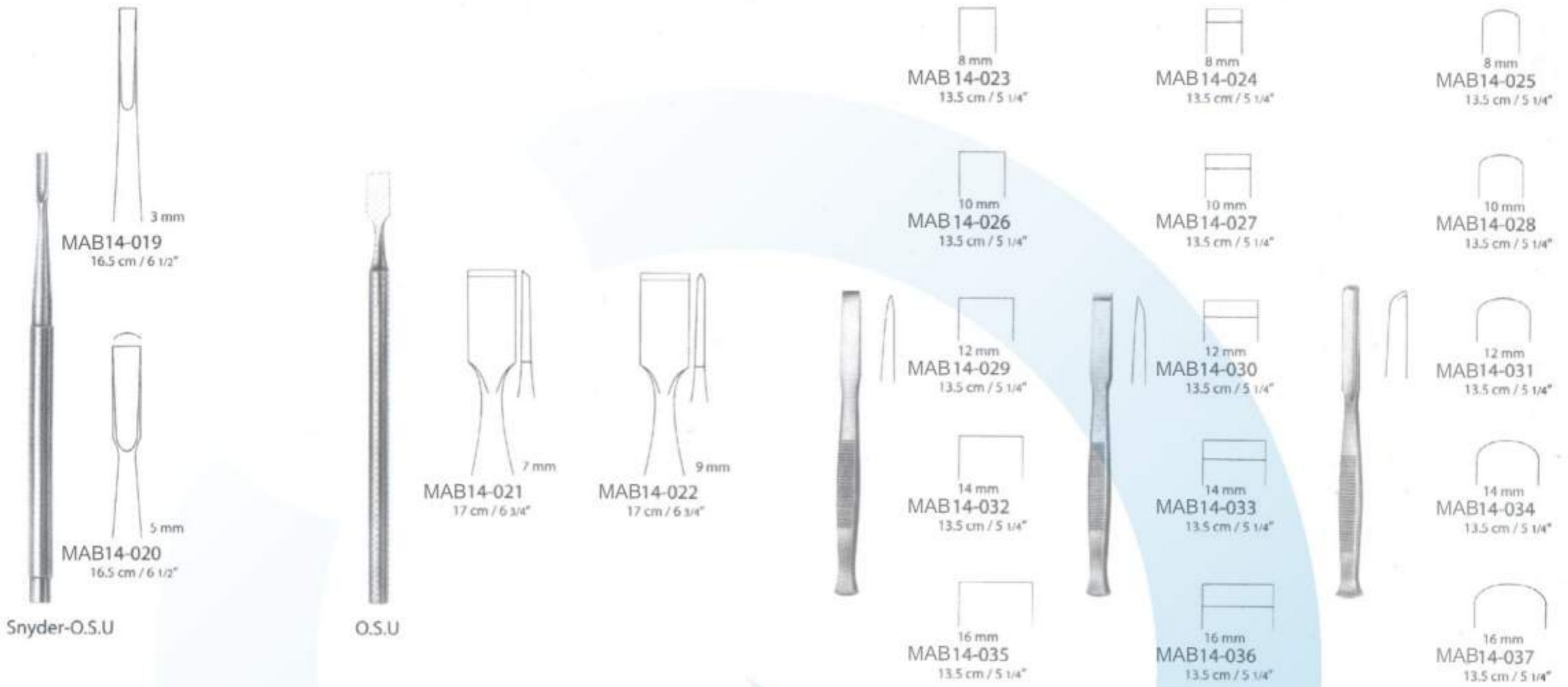

Knochenchirurgie . Chirurgie osseuse . Chirurgia osseas  
 Flachmeißel, Hohlmeißel  
 Chisels, Gouges  
 Cinceles, Gubias  
 Ciseaux-burins, Gouges  
 Scalpelli, Sgorbie

Knochenchirurgie . Bone Surgery . Cirugía ósea  
 Flachmeißel, Osteotome, Hohlmeißel  
 Chisels, Osteotomes, Gouges  
 Cinceles, Osteótomos, Gubias  
 Ciseaux-burins, Osteótomos, Gouges  
 Scalpelli, Osteotomi, Sgorbie

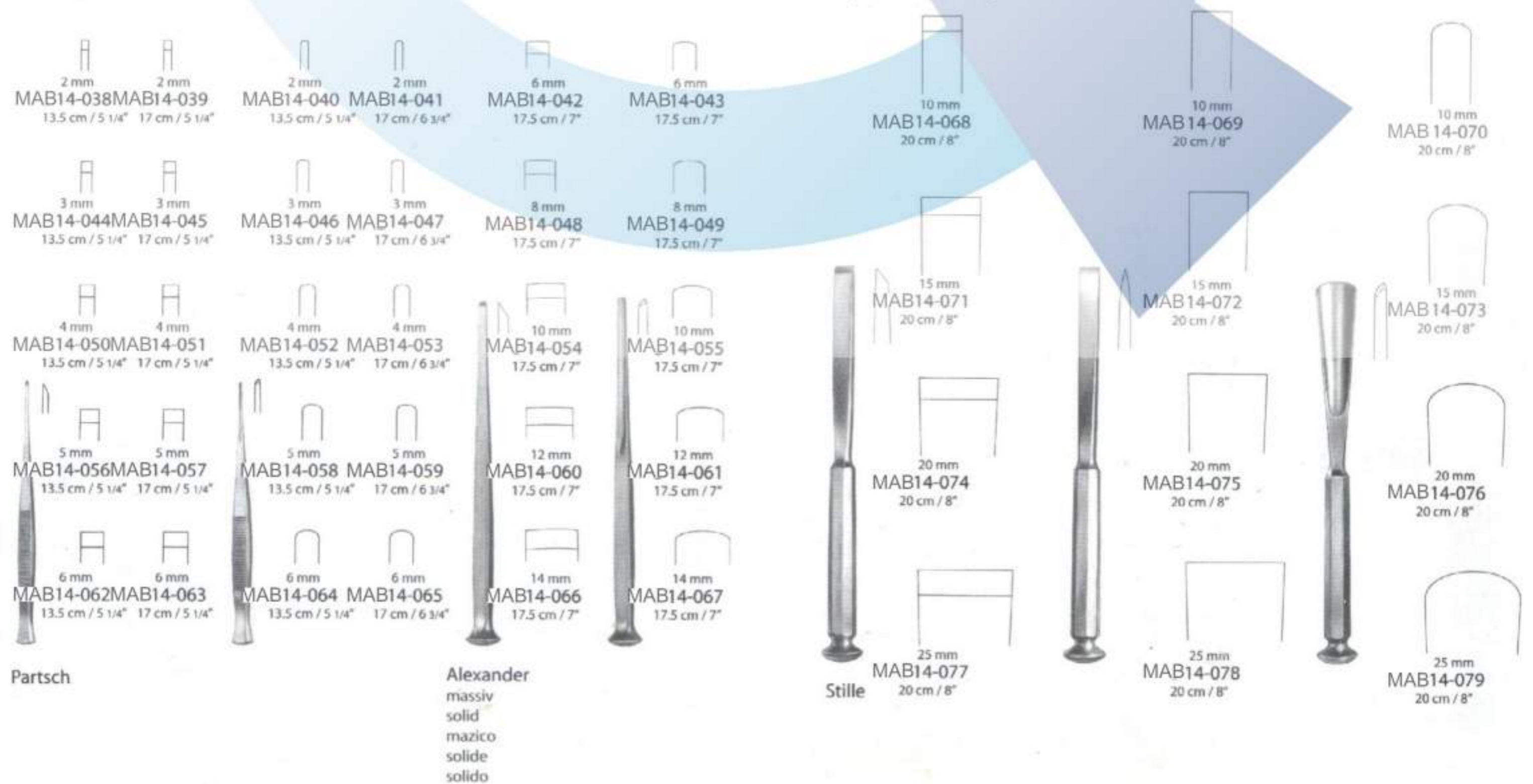



**Knochenchirurgie . Chirurgie osseuse . Chirurgia ossea**

**Meißelklingen, Meißelgriff**

**Chisel Blades, Chisel Handle**

**Hojas de cincel, Mango para hojas de cincel**

**Lames-gouges, Manche pour ciseaux-burins**

**Lame per sgorbie, Manico per scalpello**

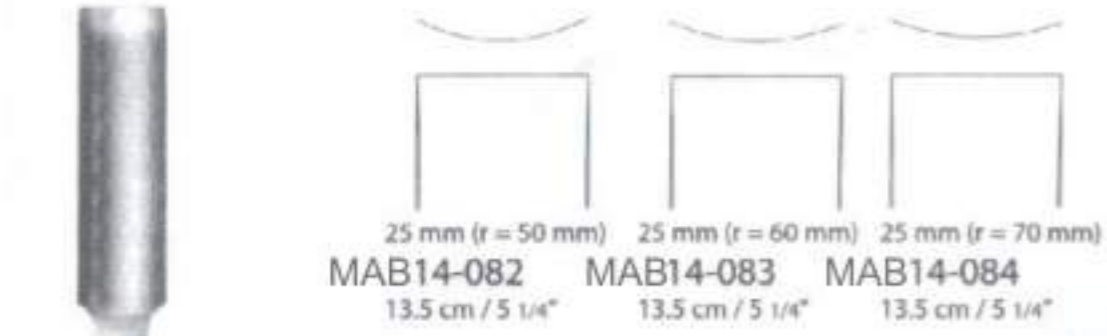

Hohlmeißelklingen,  
auswechselbar  
Gouge blades,  
interchangeable  
Hojas de gubia,  
intercambiables  
Lames-gouges,  
interchangeables  
Lame  
intercambiabili,  
concavo



Meißelklingen,  
auswechselbar  
Chisel blades,  
interchangeable  
Hojas de cincel,  
intercambiables  
Lames ciseaux-burin,  
interchangeables  
Lame intercambiabili

**MAB14-080**

9 cm / 3 1/2"  
Spannschlüssel  
Key  
Llave  
Clé  
Chiave

**MAB14-081**

Ersatzschraube  
Spare Screw  
Tornillo de repuesto  
Vis de rechange  
Vite di ricambio  
23-130-00



Osteotomklingen,  
auswechselbar  
Osteotome blades,  
interchangeable  
Hojas de osteótomo,  
intercambiables  
Lame per osteotomia,  
intercambiabili



**Knochenchirurgie . Bone Surgery . Cirugía ósea**

**Spongiosaentnahmemeißel**

**Spongiosa Gouges**

**Cinceles de esponjosa**

**Ciseaux-burinx pour spongiosa**

**Scalpelli per spongiosa**



Lexer

Lexer

**Knochenchirurgie . Chirurgie osseuse . Chirurgia ossea**

**Osteotome, Hohlmeißel**

**Osteotomes, Gouges**

**Osteótomos, Gubias**

**Ostéotomes, Gouges**

**Osteotomi, Sgorbie**



Lexer,Mini

Lexer,Mini

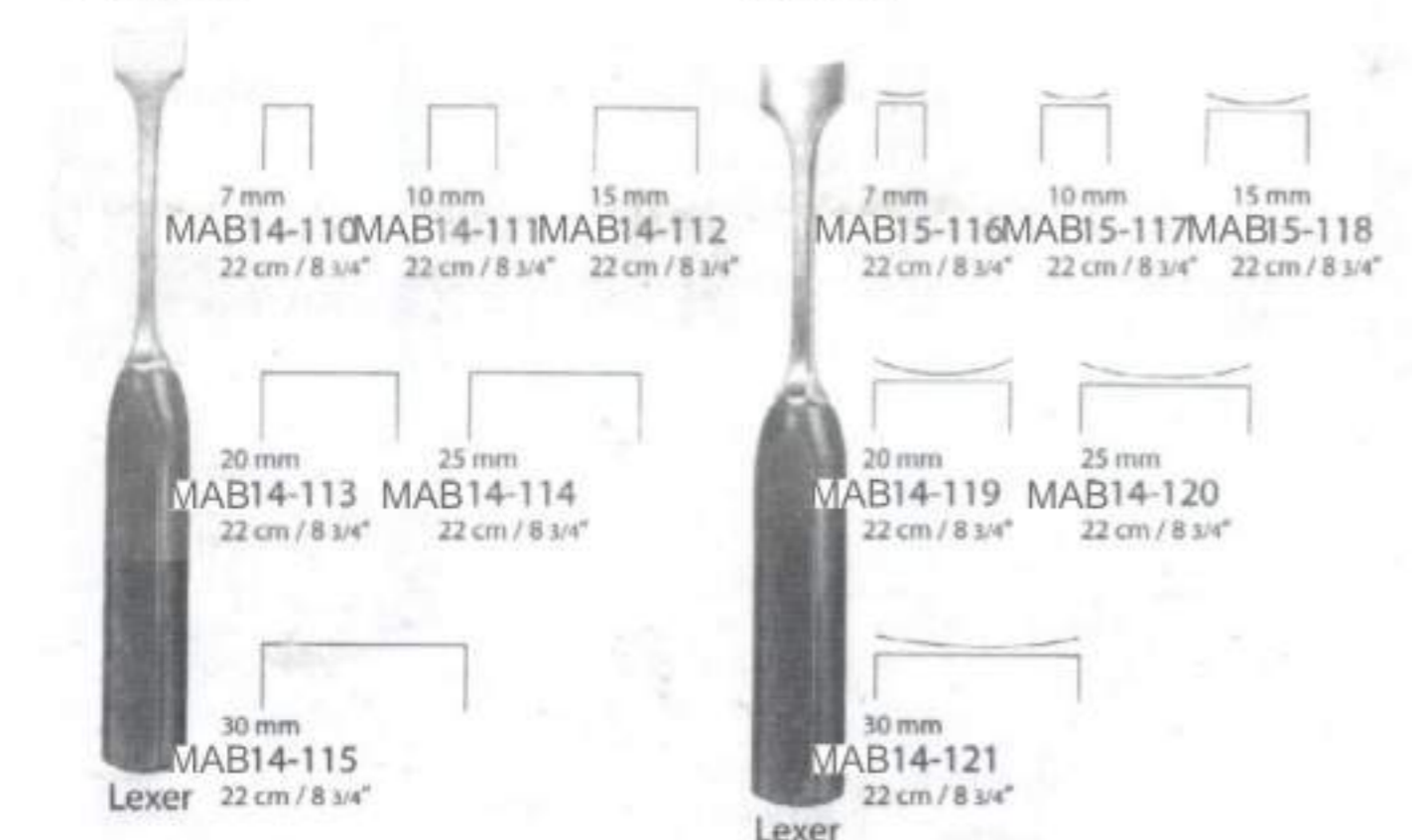

Lexer

Lexer

**Knochenchirurgie . Bone Surgery . Cirugía ósea**

**Osteotome**

**Osteotomes**

**Osteótomos**

**Ostéotomes**

**Osteotomi**

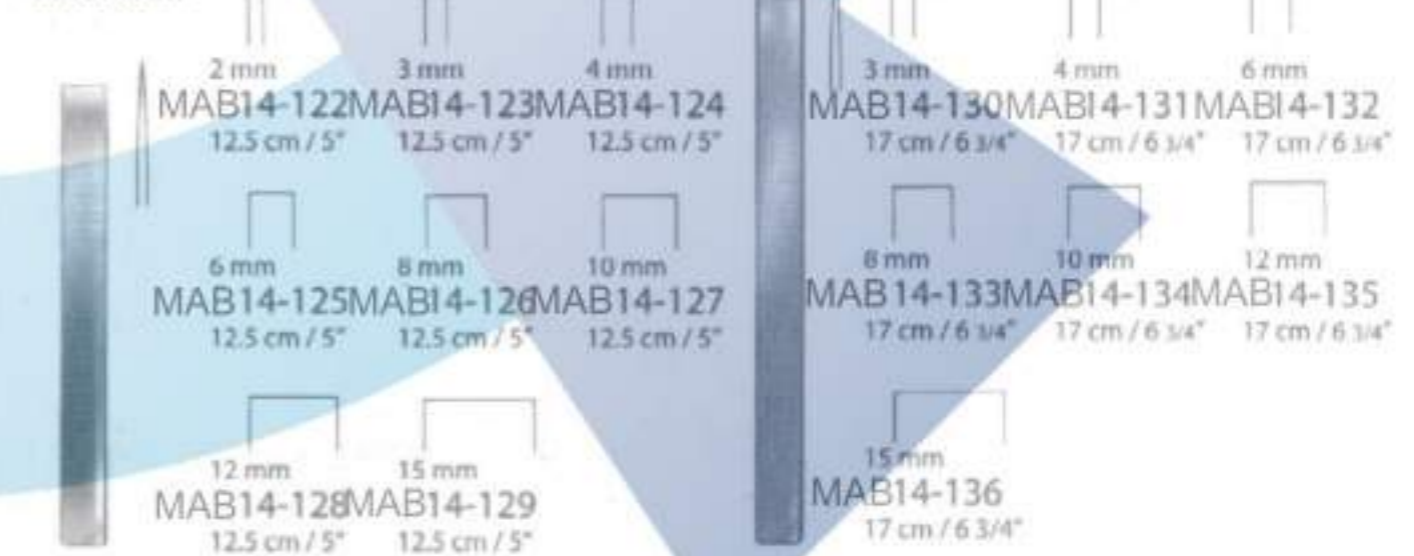

Lambotte-Mini

Lambotte-Mini

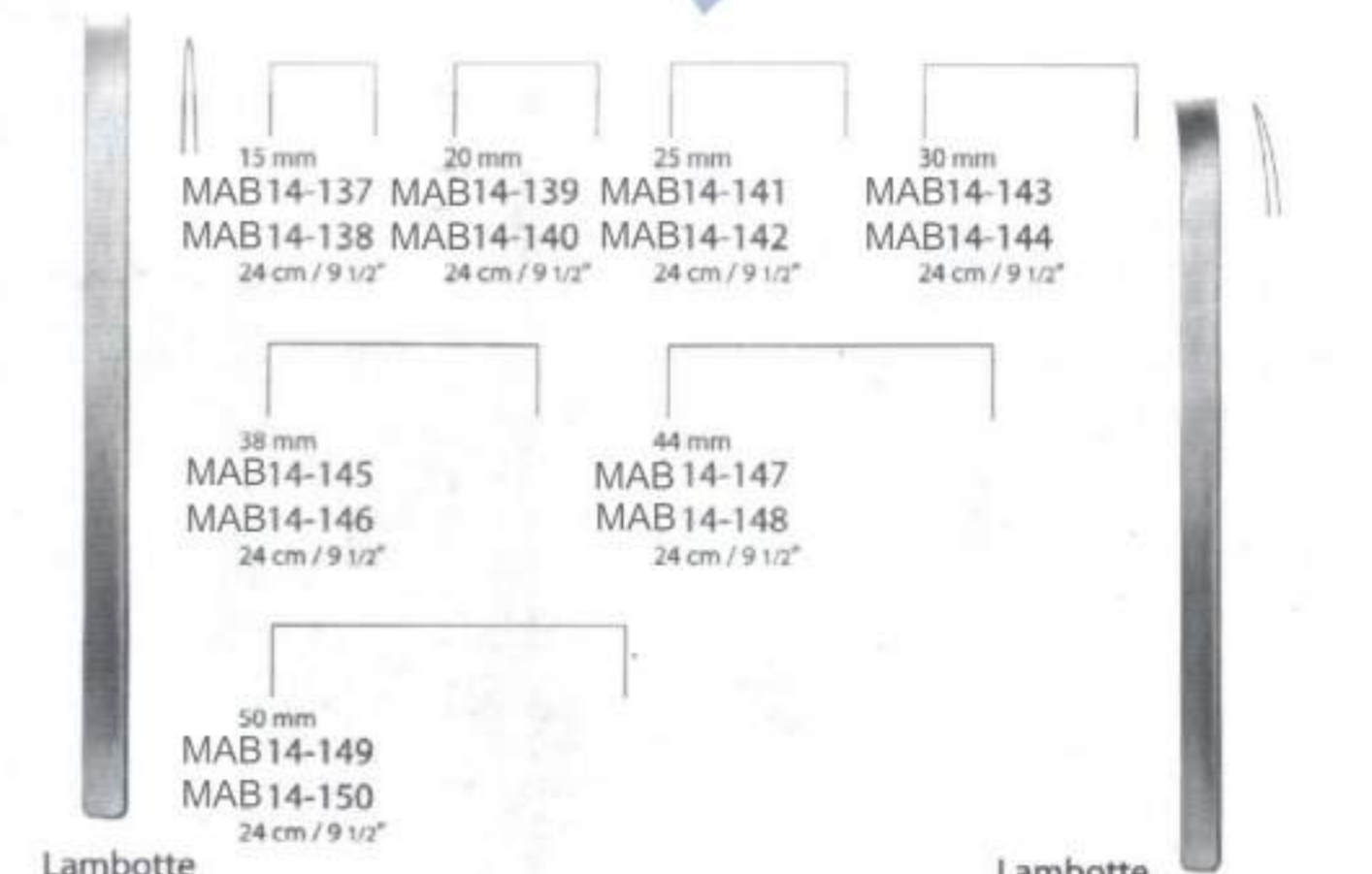

Lambotte

Lambotte



**Knochenchirurgie . Chirurgie osseuse . Chirurgia ossea**  
**Osteotome, Hohlmeißel**  
**Osteotomes, Gouges**  
**Osteótomos, Gubias**  
**Ostéotomes, Gouges**  
**Osteotomi, Sgorbie**

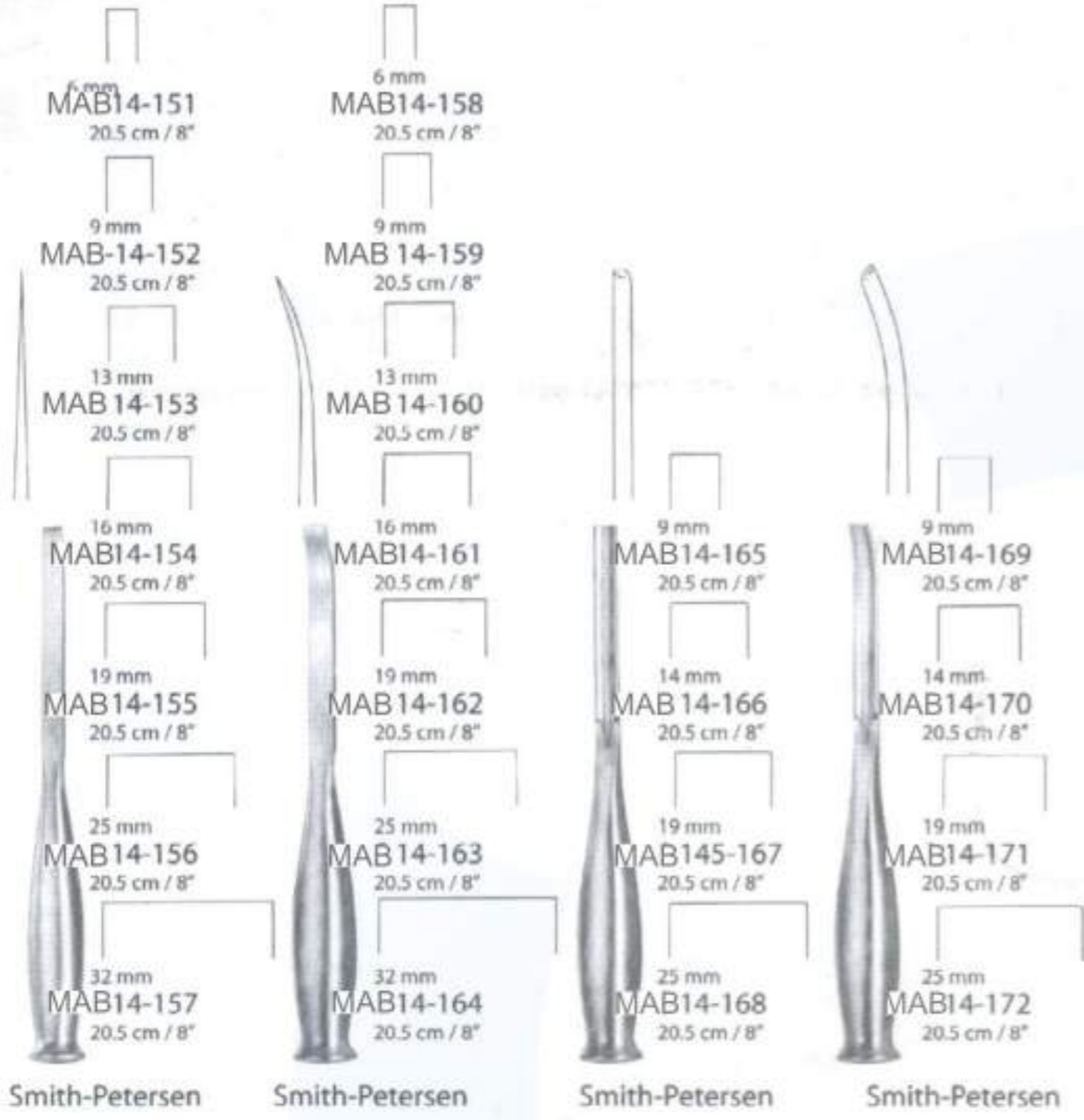

**Knochenchirurgie . Bone Surgery . Cirugía ósea**  
**Osteotome, Flachmeißel**  
**Osteotomes, Chisels**  
**Osteótomos, Cinceles**  
**Ostéotomes, Ciseaux-burins**  
**Osteotomi, Scalpelli**

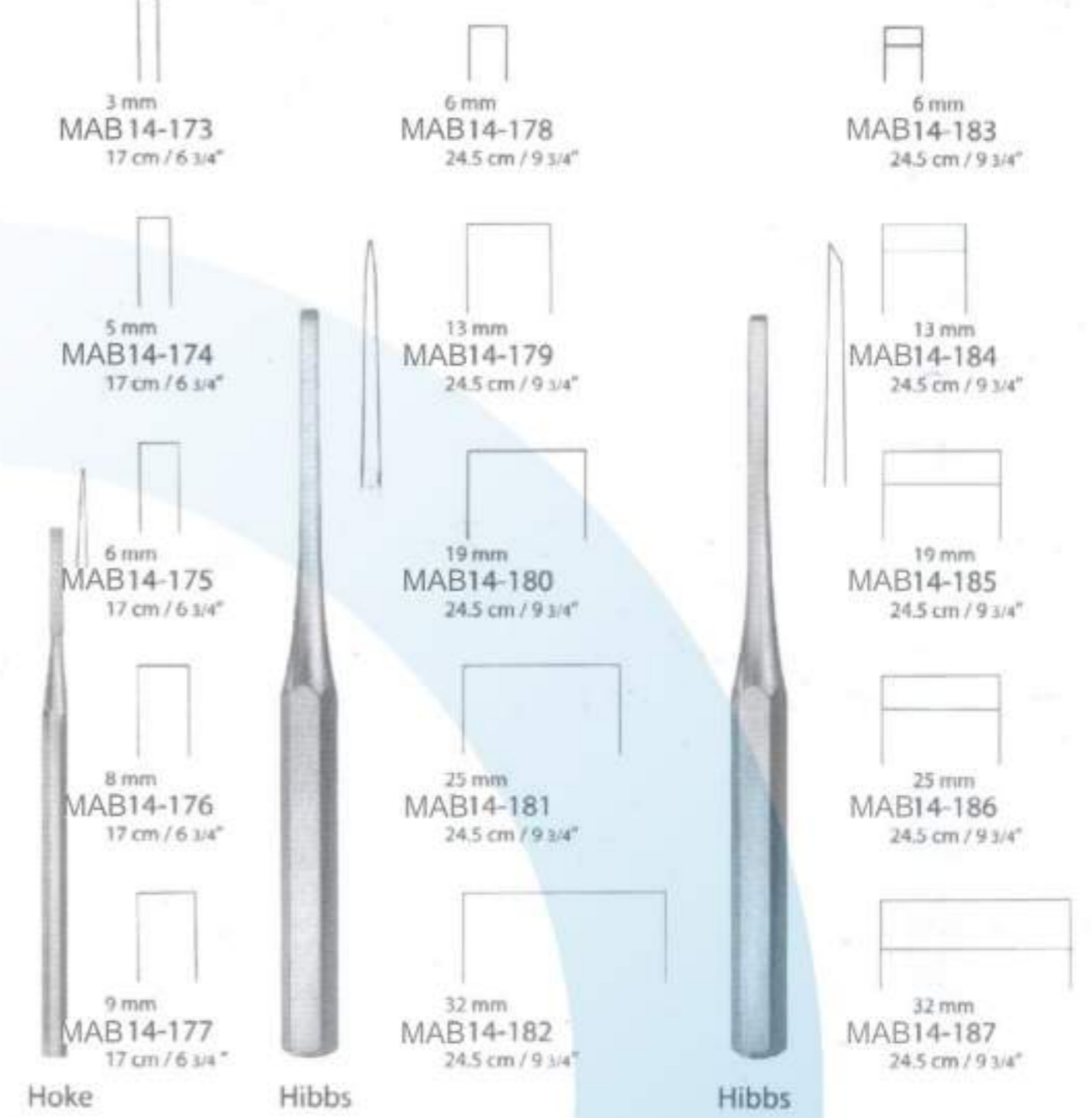

**Knochenchirurgie . Chirurgie osseuse . Chirurgia ossea**  
**Osteotome, Hohlmeißel**  
**Osteotomes, Gouges**  
**Osteótomos, Gubias**  
**Ostéotomes, Gouges**  
**Osteotomi, Sgorbie**

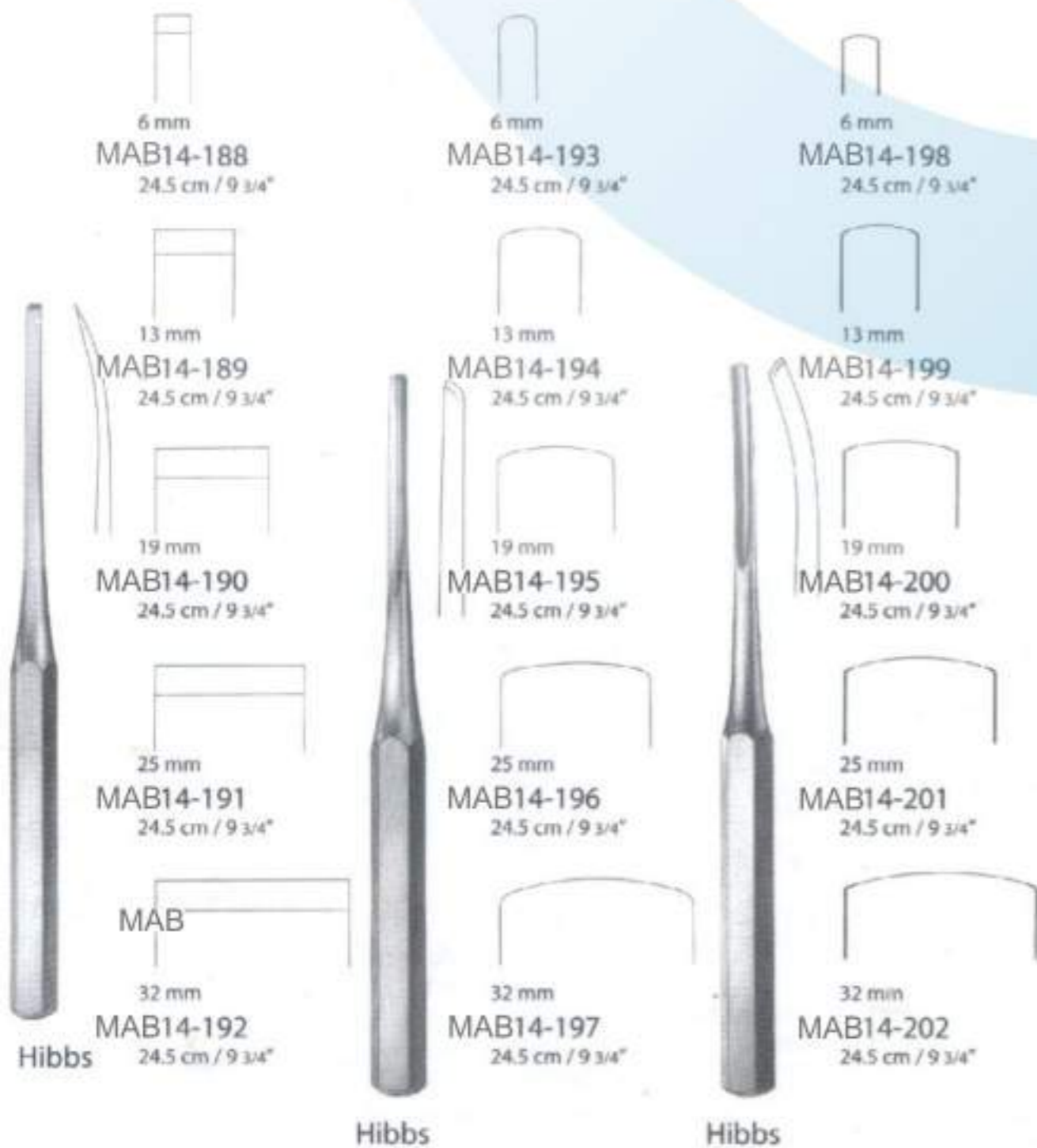

**Knochenchirurgie . Bone Surgery . Cirugía ósea**  
**Knochenrasp**  
**Bone Rasps**  
**Escofinas para hueso**  
**Râpes pour os**  
**Raspe per ossa**

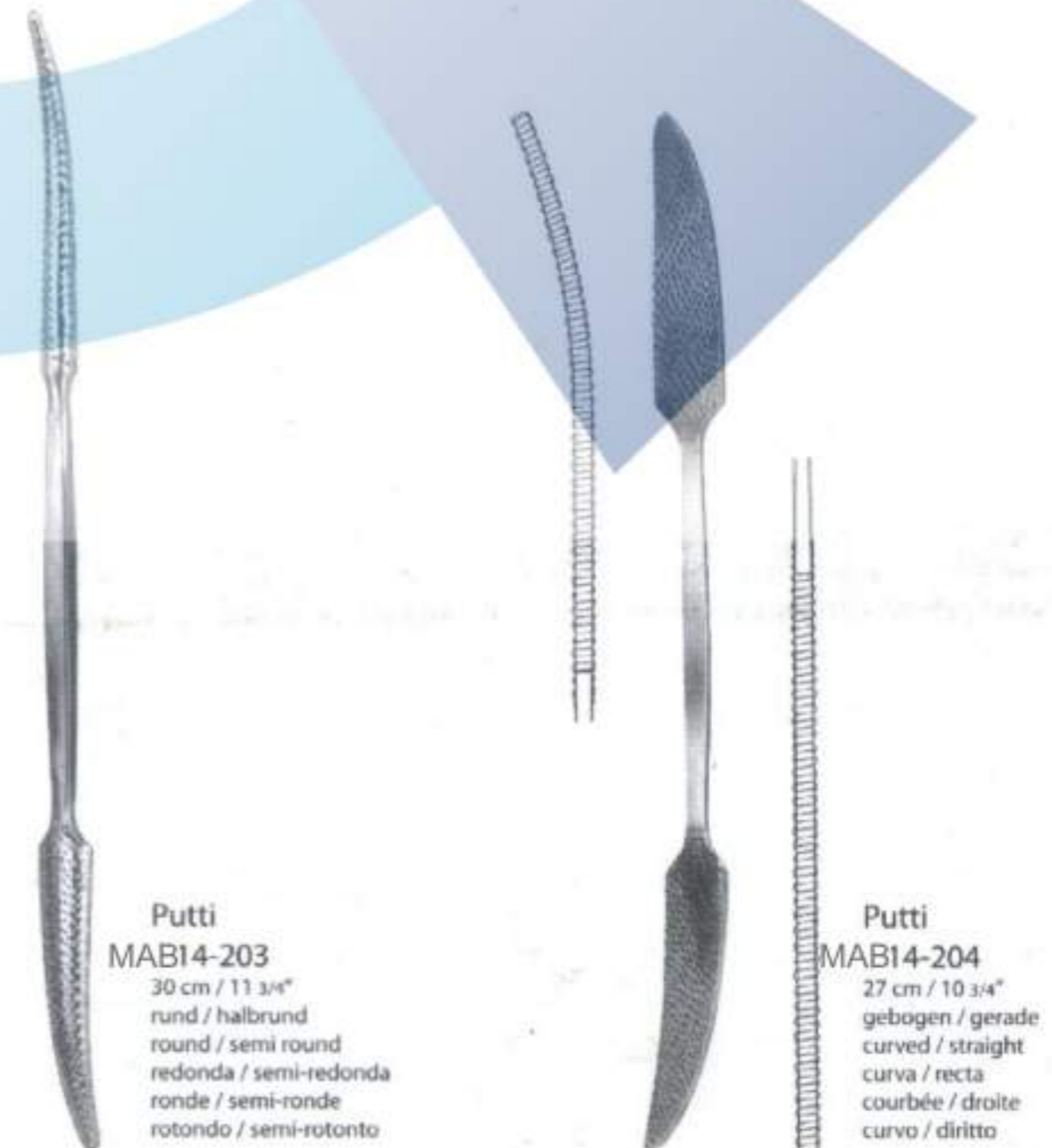



Knochenchirurgie . Bone Surgery . Cirugía ósea  
 Spongiosaentnahmemeißel, Stößel  
 Spongiosa Gouges, Tampers  
 Cinceles de esponjosa, Punzones metálicos  
 Ciseaux-burinx pour spongiosa, Pions métalliques  
 Scalpelli per spongiosa, Pestoni metallici





Vickers  
 MAB14-205  
 18 cm / 7"

- 2 mm Ø  
 MAB14-206  
 15.5 cm / 6"
- 3 mm Ø  
 MAB14-207  
 15.5 cm / 6"
- 4 mm Ø  
 MAB14-208  
 15.5 cm / 6"
- 5 mm Ø  
 MAB14-209  
 15.5 cm / 6"
- 6 mm Ø  
 MAB14-210  
 15.5 cm / 6"
- 8 mm Ø  
 MAB14-211  
 15.5 cm / 6"
- 10 mm Ø  
 MAB14-212  
 15.5 cm / 6"

Knochenchirurgie . Chirurgie osseuse . Chirurgia ossea  
 Hämmer  
 Mallets  
 Martillos  
 Maillets  
 Martelli

 Williger bleigefüllt lead filled relleno de plomo riempimento di piombo	 MAB14-213 24 cm / 9 1/2" Kopf head tête testa 26 mm Ø MABgewicht weight peso poids peso 300 gr.	 Doyen	 MAB14-216 21 cm / 8 1/4" Kopf head tête testa 25 mm Ø MABgewicht weight peso poids peso 120 gr.
 Williger bleigefüllt lead filled relleno de plomo riempimento di piombo	 MAB14-214 24 cm / 9 1/2" Kopf head tête testa 28 mm Ø Gewicht weight peso poids peso 340 gr.	 Doyen	 MAB14-217 21 cm / 8 1/4" Kopf head tête testa 30 mm Ø Gewicht weight peso poids peso 180 gr.
 Williger bleigefüllt lead filled relleno de plomo riempimento di piombo	 MAB14-215 24 cm / 9 1/2" Kopf head tête testa 30 mm Ø Gewicht weight peso poids peso 400 gr.	 Doyen	 MAB14-218 21.5 cm / 8 1/2" Kopf head tête testa 35 mm Ø Gewicht weight peso poids peso 260 gr.

Knochenchirurgie . Bone Surgery . Cirugía ósea  
 Hämmer  
 Mallets  
 Martillos  
 Maillets  
 Martelli

 Collin MAB14-220 20 cm / 8" Kopf head tête testa 30 mm Ø Gewicht weight peso poids peso 220 gr.	 Lucae MAB14-219 19.5 cm / 7 3/4" Kopf head tête testa 19 mm Ø Gewicht weight peso poids peso 230 gr.	 Cottle MAB14-221 19 cm / 7 1/2" Plan / Konvex Plane / convex Plano / convexo Plano / convesso
---	---	--

Knochenchirurgie . Chirurgie osseuse . Chirurgia ossea  
 Hämmer  
 Mallets  
 Martillos  
 Maillets  
 Martelli

 Williger MAB14-222 16.5 cm / 6 1/2" Kunststoffgriff plastic handle mango de plástico manche en matière plastique manico in plastica	 Mead MAB14-224 19 cm / 7 1/2" mit auswechselbaren Kunststoffbacken with interchangeable plastic disks con tapas intercambiabiles avec plaques interchangeables con placche intercambiabili	 Partsch MAB14-225 19 cm / 7 1/2" mit Hohlheft with hollow handle con mango hueco avec manche creux con manico vuoto
---	---	---



**Knochenchirurgie . Bone Surgery . Cirugía ósea**

**Hämmer  
Mallets  
Martillos  
Maillets  
Martelli**

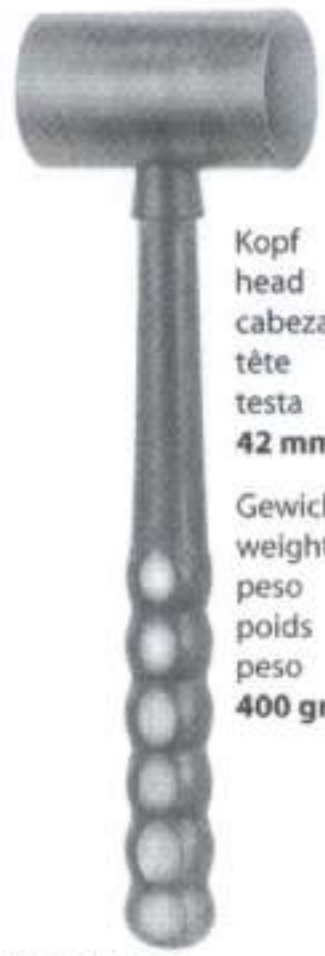

Kopf head  
cabeza  
tête  
testa  
42 mm Ø

Gewicht weight  
peso peso  
poids poids  
peso peso  
400 gr.

**MAB14-226**  
26 cm / 10 1/4"  
aus Kunststoff  
mit Bleifüllung  
made of plastic  
with lead filling  
de plástico  
con relleno de plomo  
en matière plastique  
remplissage de plomb  
in plastica  
ripieno di piombo



Kopf head  
cabeza  
tête  
testa  
42 mm Ø

Gewicht weight  
peso peso  
poids poids  
peso peso  
250 gr.

**MAB14-227**  
26 cm / 10 1/4"  
aus Kunststoff  
ohne Blei  
made of plastic  
without lead  
de plástico  
sin plomo  
en matière plastique  
sans plomb  
in plastica  
senza piombo



Kopf head  
cabeza  
tête  
testa  
42 mm Ø

Gewicht weight  
peso peso  
poids poids  
peso peso  
400 gr.

**MAB14-228**  
26 cm / 10 1/4"  
aus Kunststoff  
mit Bleifüllung  
made of plastic  
with lead filling  
de plástico  
con relleno de plomo  
en matière plastique  
remplissage de plomb  
in plastica  
ripieno di piombo

**Knochenchirurgie . Chirurgie osseuse . Chirurgia ossea**

**Hämmer  
Mallets  
Martillos  
Maillets  
Martelli**



Kopf head  
cabeza  
tête  
testa  
42 / 30 mm Ø

Gewicht weight  
peso peso  
poids poids  
peso peso  
530 gr.

**MAB14-230**  
26 cm / 10 1/4"  
Kunststoffgriff  
plastic handle  
mango de plástico  
manche en matière-  
plastique  
manico in plastica



Kopf head  
cabeza  
tête  
testa  
30 mm Ø

Gewicht weight  
peso peso  
poids poids  
peso peso  
480 gr.

**MAB14-231**  
24 cm / 9 1/2"  
Kunststoffgriff  
plastic handle  
mango de plástico  
manche en matière  
plastique  
manico in plastica



Kopf head  
cabeza  
tête  
testa  
37 mm Ø

Gewicht weight  
peso peso  
poids poids  
peso peso  
370 gr.

**MAB14-232**  
24 cm / 9 1/2"  
Backen und Griff aus Kunststoff  
disks and handle of plastic  
mango y tapas de plástico  
manche et plaques en matière  
plastique  
manico e placche in plastica



Kopf head  
cabeza  
tête  
testa  
30 mm Ø

Gewicht weight  
peso peso  
poids poids  
peso peso  
125 gr.

**MAB14-233**  
22 cm / 8 3/4"  
aus Kunststoff  
made of plastic  
de plástico  
en matière plastique  
in plastica

**Knochenchirurgie . Bone Surgery . Cirugía ósea**

**Hämmer  
Mallets  
Martillos  
Maillets  
Martelli**



Kopf head  
cabeza  
tête  
testa  
30 mm Ø

Gewicht weight  
peso peso  
poids poids  
peso peso  
450 gr.

**MAB14-234**  
26.5 cm / 10 1/2"  
Kunststoffgriff  
plastic handle  
mango de plástico  
manche en matière  
plastique  
manico in plastica



Kopf head  
cabeza  
tête  
testa  
50 mm Ø

Gewicht weight  
peso peso  
poids poids  
peso peso  
900 gr.

**MAB14-235**  
26.5 cm / 10 1/2"  
Kunststoffgriff  
plastic handle  
mango de plástico  
manche en matière  
plastique  
manico in plastica



Kopf head  
cabeza  
tête  
testa  
25 mm Ø

Gewicht weight  
peso peso  
poids poids  
peso peso  
300 gr.

**Vickers  
MAB14-236**  
19 cm / 7 1/2"  
Nylonbacken  
Kunststoffgriff  
nylon disks  
plastic handle  
tapas de nilón  
mango de plástico  
plaque en nylon  
manche en matière plastique  
placche in nylon  
manico in plastica



**Herbert  
MAB14-237**  
19 cm / 7 1/2"  
für Ulnakopf-Prothesen  
Kunststoffgriff  
for ulnar head prosthesis  
plastic handle  
para prótesis de la cabeza ulnar  
mango de plástico  
pour prothèse de la tête ulna  
manche en matière plastique  
per protesi per la testa ulnare  
manico in plastica

**Knochenchirurgie . Chirurgie osseuse . Chirurgia ossea**

**Scharfe Löffel  
Bone Curettes  
Cucharillas cortantes  
Curettes tranchantes  
Curette taglienti**



**Volkman**  
oval, mit Kunststoffgriff  
oval, with plastic handle  
ovalada, con mango plástico  
ovale, avec manche en matière plastique  
ovala, con manico in plastica



Fig.0000  
**MAB14-238**  
18.5 cm / 7 1/4"



Fig.000  
**MAB14-239**  
18.5 cm / 7 1/4"



Fig.00  
**MAB14-240**  
18.5 cm / 7 1/4"



Fig.0  
**MAB14-241**  
18.5 cm / 7 1/4"



Fig.1  
**MAB14-242**  
18.5 cm / 7 1/4"



Fig.2  
**MAB14-243**  
18.5 cm / 7 1/4"



Fig.3  
**MAB14-244**  
19 cm / 7 1/2"



Fig.4  
**MAB14-245**  
19 cm / 7 1/2"



Fig.5  
**MAB14-246**  
19 cm / 7 1/2"



Fig.6  
**MAB14-247**  
19 cm / 7 1/2"



**Volkman**  
oval, mit Kunststoffgriff  
oval, with plastic handle  
ovalada, con mango plástico  
ovale, avec manche en matière plastique  
ovala, con manico in plastica



Fig.4  
**MAB14-248**  
27.5 cm / 10 3/4"



Fig.0  
**MAB14-249**  
27.5 cm / 10 3/4"



Fig.1  
**MAB14-250**  
27.5 cm / 10 3/4"

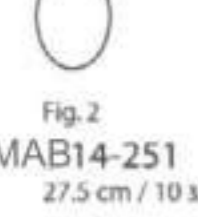

Fig.2  
**MAB14-251**  
27.5 cm / 10 3/4"

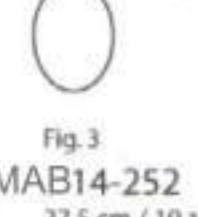
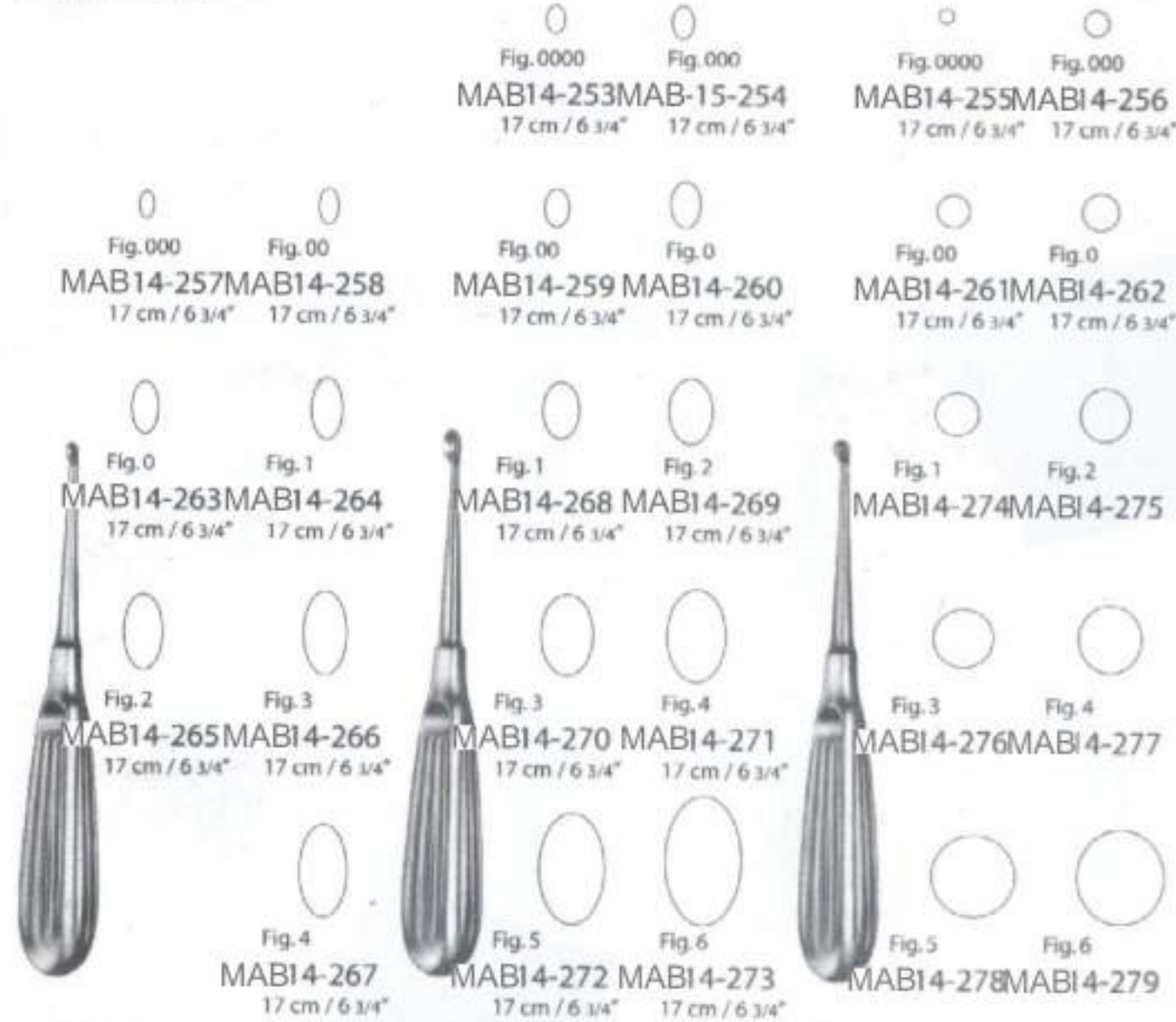

Fig.3  
**MAB14-252**  
27.5 cm / 10 3/4"



**Knochenchirurgie . Bone Surgery . Cirugía ósea**  
**Scharfe Löffel**  
**Bone Currettes**  
**Cucharillas cortantes**  
**Curettes tranchantes**  
**Curette taglienti**



**Schede**  
 oval, mit Hohlheft  
 oval, with hollow handle  
 ovalada, con mango hueco  
 ovale avec manche creux  
 ovale, con manico vuoto

**Volkman**  
 oval, mit Hohlheft  
 oval, with hollow handle  
 ovalada, con mango hueco  
 ovale, avec manche creux  
 ovale, con manico vuoto

**Bruns**  
 rund, mit Hohlheft  
 round, with hollow handle  
 redonda, con mango hueco  
 rond, avec manche creux  
 rotonda, con manico vuoto

**Knochenchirurgie . Chirurgie osseuse . Chirurgia ossea**  
**Scharfe Löffel**  
**Bone Currettes**  
**Cucharillas cortantes**  
**Curettes tranchantes**  
**Curette taglienti**

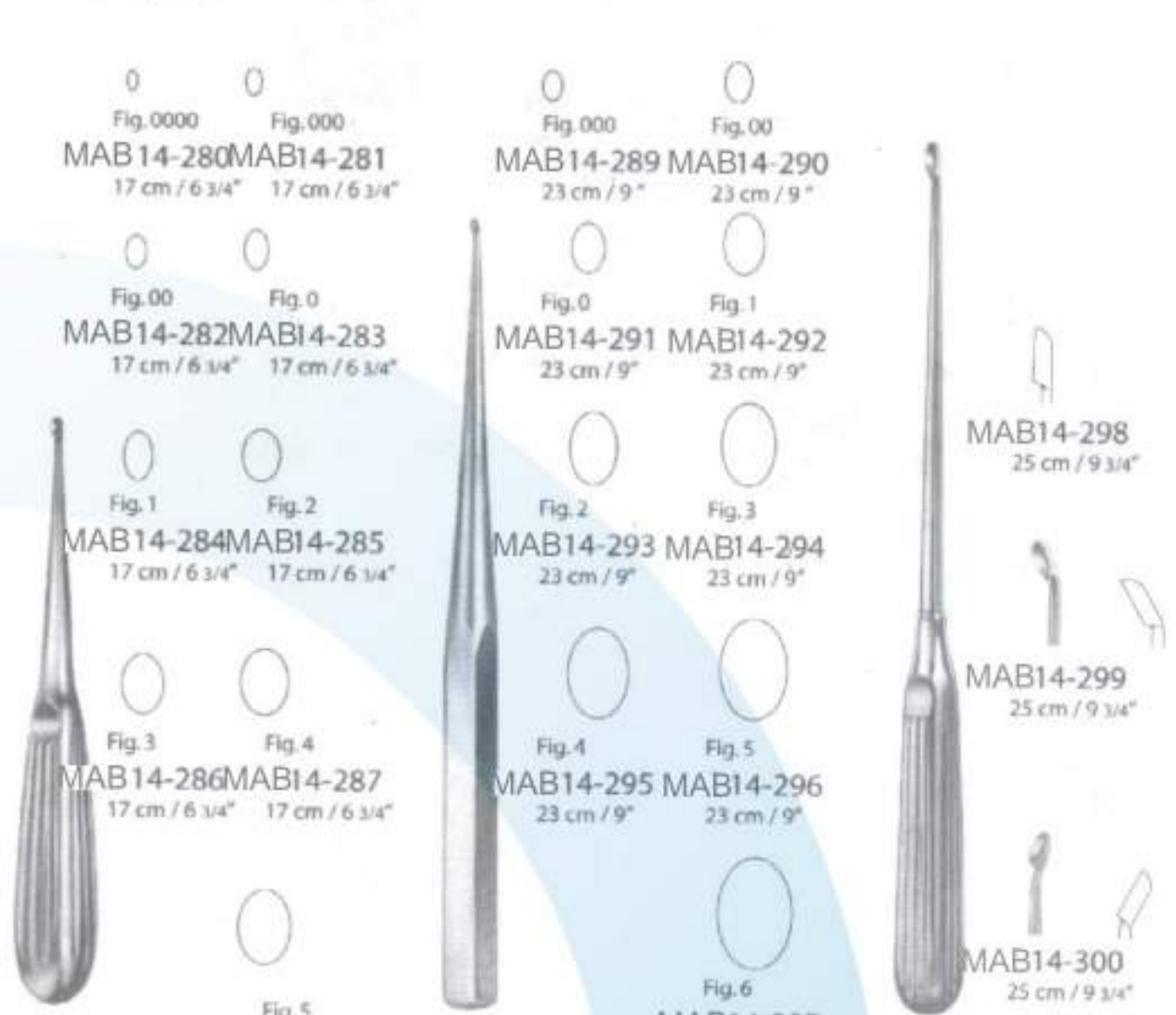

**Spratt**  
 oval, mit Hohlheft  
 oval, with hollow handle  
 ovalada, con mango hueco  
 ovale, avec manche creux  
 ovale, con manico vuoto

**Bruns**  
 oval, massiv  
 oval, solid  
 ovalada, maciza  
 ovale, solide  
 ovale, solida

**Scoville**  
 oval, mit Hohlheft  
 oval, with hollow handle  
 ovalada, con mango hueco  
 ovale, avec manche creux  
 ovale, con manico vuoto

**Knochenchirurgie . Bone Surgery . Cirugía ósea**  
**Scharfe Löffel**  
**Bone Currettes**  
**Cucharillas cortantes**  
**Curettes tranchantes**  
**Curette taglienti**

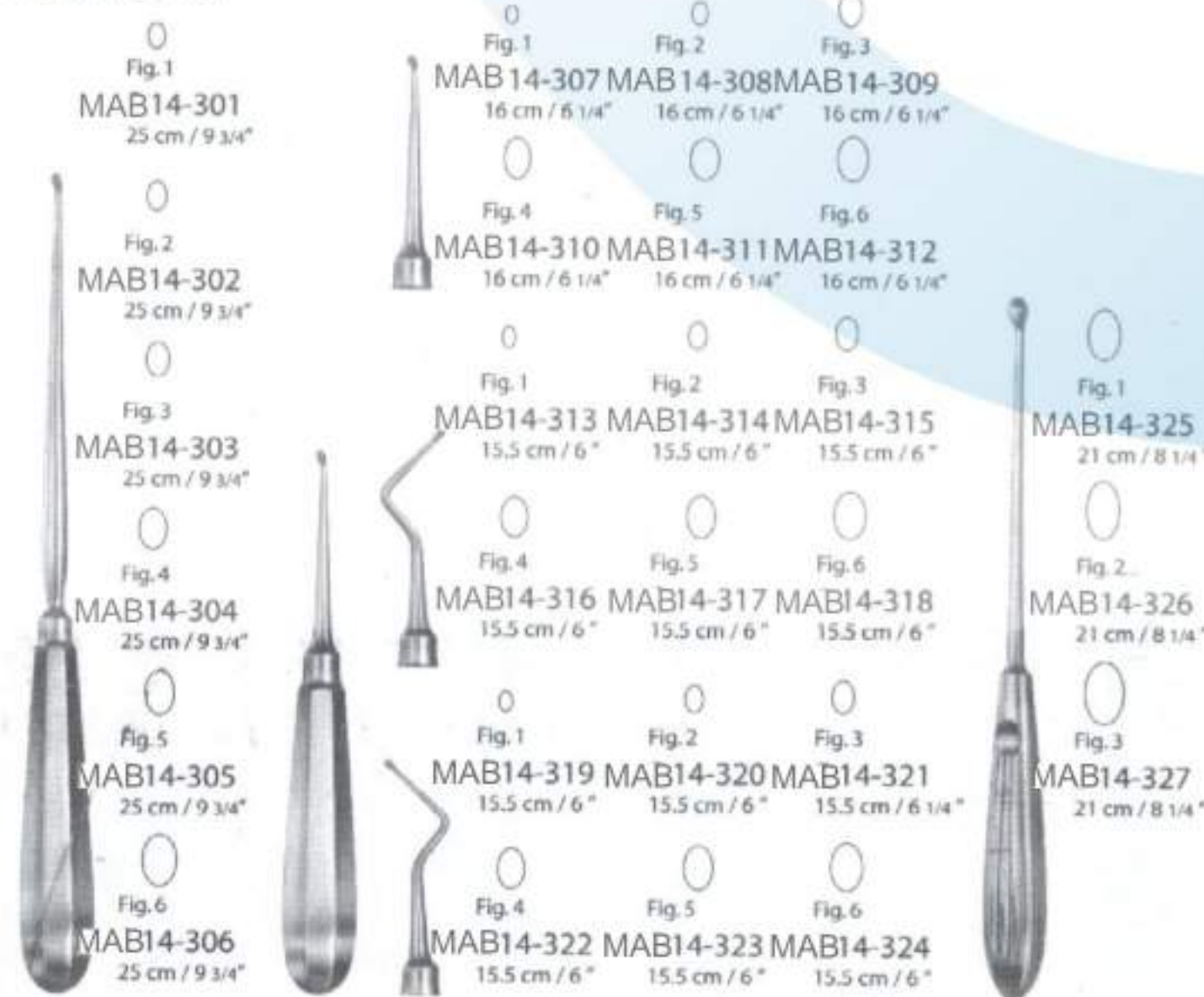

**Simon**  
 oval, mit Hohlheft  
 oval, with hollow handle  
 ovalada, con mango hueco  
 ovale, avec manche creux  
 ovale, con manico vuoto

**Modell USA**  
 oval, mit Hohlheft  
 oval, with hollow handle  
 ovalada, con mango hueco  
 ovale, avec manche creux  
 ovale, con manico vuoto

**Halle**  
 oval, biegsamer Schaft, mit Hohlheft  
 oval, malleable shaft, with hollow handle  
 ovalada, vástago maleable, con mango hueco  
 ovale, avec tige malléable, avec manche creux  
 ovale, con gambo malleabile, con manico vuoto

**Knochenchirurgie . Chirurgie osseuse . Chirurgia ossea**  
**Scharfe Doppellöffel**  
**Bone Currettes, double-ended**  
**Cucharillas de doble extremo**  
**Curettes doubles**  
**Curette doppia**



**Volkman**

**Volkman**

**MAB14-340**  
 21 cm / 8 1/4"

**Williger**

**MAB14-334**  
 13.5 cm / 5 1/4"

**MAB14-335**  
 13.5 cm / 5 1/4"

**MAB14-336**  
 13.5 cm / 5 1/4"



**Knochenchirurgie . Bone Surgery . Cirugía ósea**  
**Scharfe Doppellöffel**  
**Bone Curettes, double-ended**  
**Cucharillas de doble extremo**  
**Curettes doubles**  
**Curette doppia**



Williger  
 oval  
 oval  
 ovalada  
 ovale  
 ovale



Hemingway  
 8-kant Griff  
 octagonal handle  
 mango octagonal  
 manche octogonal  
 manico ottagonale



Hemingway  
 8-kant Griff  
 octagonal handle  
 mango octagonal  
 manche octogonal  
 manico ottagonale

Hemingway-Martin  
 8-kant Griff  
 octagonal handle  
 mango octagonal  
 manche octogonal  
 manico ottagonale



Hemingway  
 8-kant Griff  
 octagonal handle  
 mango octagonal  
 manche octogonal  
 manico ottagonale



Hemingway  
 8-kant Griff  
 octagonal handle  
 mango octagonal  
 manche octogonal  
 manico ottagonale

**Knochenchirurgie . Chirurgie osseuse . Chirurgia ossea**  
**Scharfe Doppellöffel**  
**Bone Curettes, double-ended**  
**Curetas de doble extremo**  
**Curettes doubles**  
**Curette doppia**



Miller-Colburn



Hemingway-Martin  
 8-kant Griff  
 octagonal handle  
 mango octagonal  
 manche octogonal  
 manico ottagonale



**Knochenchirurgie . Bone Surgery . Cirugía ósea**  
**Scharfe Küretten**  
**Bone Curettes**  
**Curetas cortantes**  
**Curettes**  
**Curette**

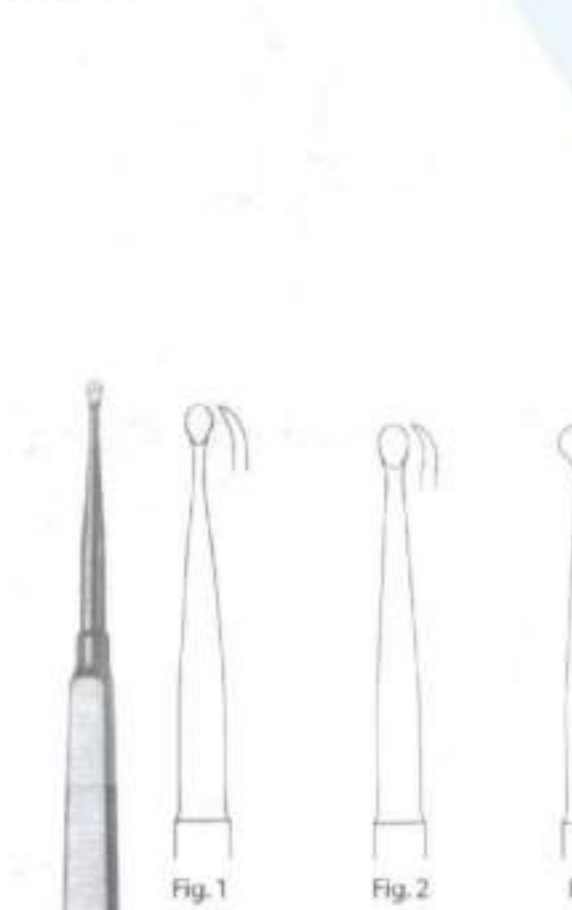

Molt



Molt  
 19 cm / 7 1/2"  
 runder Griff  
 round handle  
 mango redondo  
 manche rond  
 manico rotondo

**Knochenchirurgie . Chirurgie osseuse . Chirurgia ossea**  
**Raspatorien**  
**Periosteal Elevators**  
**Periostotomos**  
**Rugines-raspatoires**  
**Periostotomi**

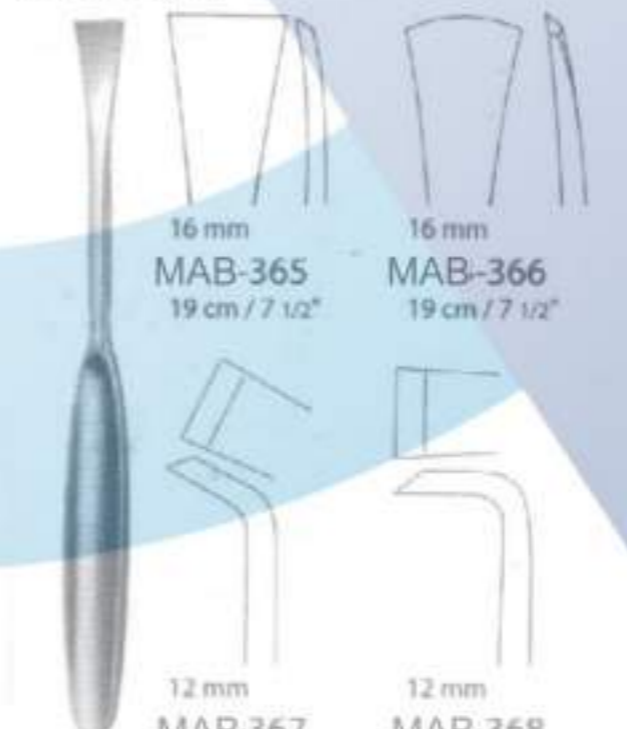

Martin-Langenbck  
 massiv  
 solid  
 macizo  
 solide  
 solido



Martin-Cushing  
 massiv  
 solid  
 macizo  
 solide  
 solido



Martin-Hoen  
 massiv  
 solid  
 macizo  
 solide  
 solido



Martin-Cushing  
 massiv  
 solid  
 macizo  
 solide  
 solido



**Knochenchirurgie . Bone Surgery . Cirugía ósea**

**Raspatorien**  
**Periosteal Elevators**  
**Periostótomos**  
**Rugines-raspatoires**  
**Periostotomi**



MAB14-377  
18.5 cm / 7 1/4"

MAB14-378  
19.5 cm / 7 3/4"

**Langenbeck**  
 mit Hohlheft  
 with hollow handle  
 con mango hueco  
 avec manche creux  
 con manico vuoto

**Langenbeck**  
 mit Hohlheft  
 with hollow handle  
 con mango hueco  
 avec manche creux  
 con manico vuoto



5 mm 6 mm 7 mm  
 MAB14-379 MAB14-380 MAB14-381  
 16 cm / 6 1/4" 16 cm / 6 1/4" 16 cm / 6 1/4"

fein, massiv  
 delicate, solid  
 fino, macizo  
 fin, solide  
 fino, solido

**Knochenchirurgie . Chirurgie osseuse . Chirurgia ossea**

**Raspatorien**  
**Periosteal Elevators**  
**Periostótomos**  
**Rugines-raspatoires**  
**Periostotomi**



14 mm  
 MAB14-385  
 20 cm / 8"

14 mm  
 MAB14-386  
 19 cm / 7 1/2"

19 mm  
 MAB14-387  
 20 cm / 8"

mit Kunststoffgriff  
 with plastic handle  
 con mango plástico  
 avec manche en matière  
 plastique  
 con manico in plastica

mit Kunststoffgriff  
 with plastic handle  
 con mango plástico  
 avec manche en matière  
 plastique  
 con manico in plastica

mit Kunststoffgriff  
 with plastic handle  
 con mango plástico  
 avec manche en matière  
 plastique  
 con manico in plastica



MAB14-382  
15 cm / 6"

MAB14-383  
15 cm / 6"

**Farabeuf**  
 mit Hohlheft  
 with hollow handle  
 con mango hueco  
 avec manche creux  
 con manico vuoto

**Farabeuf**  
 mit Hohlheft  
 with hollow handle  
 con mango hueco  
 avec manche creux  
 con manico vuoto



MAB14-384  
22 cm / 8 3/4"

Sedillot



6 mm  
 MAB14-388  
 18 cm / 7"

6 mm  
 MAB14-389  
 18 cm / 7"

3 mm  
 MAB14-390  
 18 cm / 7"

schmal, mit Kunststoffgriff  
 narrow, with plastic handle  
 estrecho, con mango plástico  
 étroit, avec manche en matière  
 plastique  
 diritto, con manico in plastica

schmal, mit Kunststoffgriff  
 narrow, with plastic handle  
 estrecho, con mango plástico  
 étroit, avec manche en matière  
 plastique  
 diritto, con manico in plastica

extra schmal, mit Kunststoffgriff  
 extra narrow, with plastic handle  
 muy estrecho, con mango plástico  
 très étroit, avec manche en matière  
 plastique  
 molto stretto, con manico in plastica

**Knochenchirurgie . Bone Surgery . Cirugía ósea**

**Raspatorien**  
**Periosteal Elevators**  
**Periostótomos, Legras**  
**Rugines-raspatoires, Rugines**  
**Periostotomi**



5 mm  
 MAB-391  
 12.5 cm / 5"

4 mm  
 MAB-392

5 mm  
 MAB-393

7 mm  
 MAB-394

5 mm  
 MAB-395  
 16 cm / 6 1/4"

Williger

Kahre-Williger

Williger

Williger



MAB-396  
17.5 cm / 7"

MAB-397  
17.5 cm / 7"

6 mm 8 mm  
 MAB-398 MAB-399  
 17 cm / 6 3/4" 17 cm / 6 3/4"

MAB-400  
17.5 cm / 7"  
 rechts gebogen  
 right curved  
 curvo a la derecha  
 courbé à droite  
 curvo destro

MAB-401  
17.5 cm / 7"  
 links gebogen  
 left curved  
 curvo a la izquierda  
 courbé à gauche  
 curvo sinistro

für Erwachsene  
 for adults  
 para adultos  
 pour adultes  
 per adulti

für Kinder  
 for children  
 para niños  
 pour enfants  
 per bambini

**Doyen**  
 Rippenraspatorien  
 rib Raspatories  
 Legras costales  
 Rugines pour le périoste costale  
 Periostotomi costali

mit Hohlheft  
 with hollow handle  
 con mango hueco  
 avec manche creux  
 con manico vuoto

**Knochenchirurgie . Chirurgie osseuse . Chirurgia ossea**

**Doppelraspatorien, Raspatorien**  
**Periosteal Elevators, double, Periosteal Elevators**  
**Legras de doble extremo, Periostótomos**  
**Rugines pour le périoste costal, Rugines-raspatoires**  
**Periostotomi costali, Periostotomi**

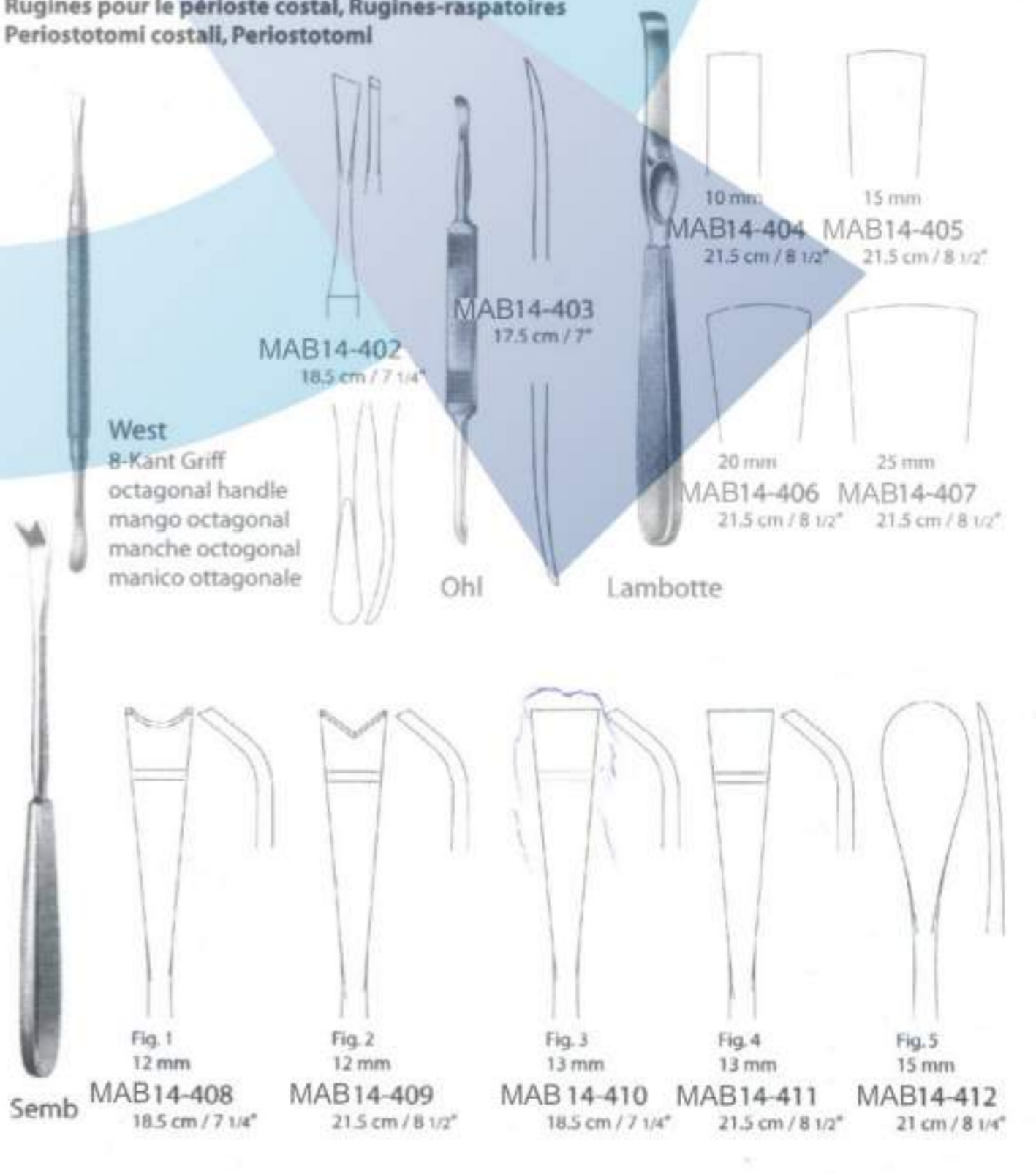

MAB14-402  
18.5 cm / 7 1/4"

MAB14-403  
17.5 cm / 7"

10 mm  
 MAB14-404  
21.5 cm / 8 1/2"

15 mm  
 MAB14-405  
21.5 cm / 8 1/2"

20 mm  
 MAB14-406  
21.5 cm / 8 1/2"

25 mm  
 MAB14-407  
21.5 cm / 8 1/2"

**West**  
 8-Kant Griff  
 octagonal handle  
 mango octogonal  
 manche octogonale  
 manico ottagonale

Ohi

Lambotte

Semb

Fig. 1  
12 mm  
 MAB14-408  
18.5 cm / 7 1/4"

Fig. 2  
12 mm  
 MAB14-409  
21.5 cm / 8 1/2"

Fig. 3  
13 mm  
 MAB14-410  
18.5 cm / 7 1/4"

Fig. 4  
13 mm  
 MAB14-411  
21.5 cm / 8 1/2"

Fig. 5  
15 mm  
 MAB14-412  
21 cm / 8 1/4"



**Knochenchirurgie . Bone Surgery . Cirugía ósea**

**Knochenfeilen**  
**Bone Files**  
**Limas para huesos**  
**Limes à os**  
**Lime per ossa**

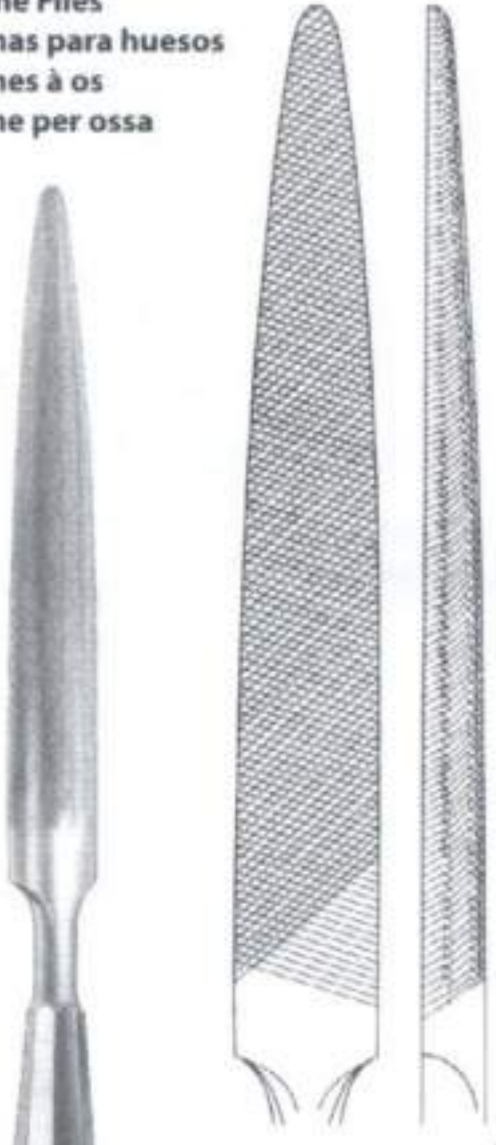

**MAB14-413**  
 28 cm / 11"  
 halbrund  
 semi round  
 semi-redonda  
 semi-ronde  
 semi-rotonda

mit Hohlheft  
 with hollow handle  
 con mango hueco  
 avec manche creux  
 con manico vuoto



**MAB14-414**  
 24.5 cm / 9 3/4"  
 halbrund  
 semi round  
 semi-redonda  
 semi-ronde  
 semi-rotonda

mit Hohlheft  
 with hollow handle  
 con mango hueco  
 avec manche creux  
 con manico vuoto



**MAB14-415**  
 22 cm / 8 3/4"  
 flach  
 flat  
 plana  
 plate  
 plana

massiv  
 solid  
 maciza  
 solide  
 solida

**Knochenchirurgie . Chirurgie osseuse . Chirurgia ossea**

**Elevatoren, Knochenfeilen**  
**Elevators, Bone Files**  
**Elevadores, Limas para huesos**  
**Élévateurs, Limes à os**  
**Elevatori, Lima per ossa**



**MAB14-416** 17 cm / 6 3/4"  
**MAB14-417** 17 cm / 6 3/4"  
**MAB14-418** 17.5 cm / 7"  
**MAB14-419** 17 cm / 6 3/4"

Adson



Miller-Colburn  
 abwärts schneidend  
 downwards cutting  
 corte abajo  
 tranchant en bas  
 tagliente in basso

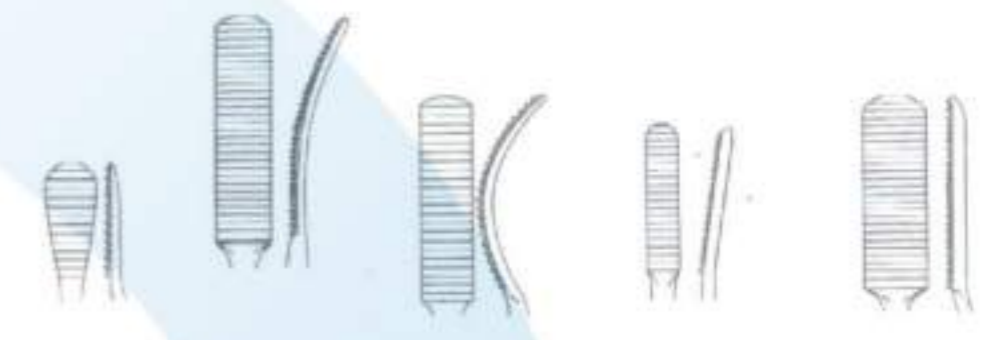

**MAB14-420** 18 cm / 7"  
**MAB14-421** 18 cm / 7"  
**MAB14-422** 18 cm / 7"  
**MAB14-423** 18 cm / 7"  
**MAB14-424** 18 cm / 7"



**Knochenchirurgie . Bone Surgery . Cirugía ósea**

**Knochenfeilen, Alveotomiefeilen**  
**Bone Files, Alveotomy Files**  
**Limas para huesos, Limas para alveolotomía**  
**Limes à os, Limes pour alvéolotomie**  
**Lima per ossa, Lime per alveolotomia**

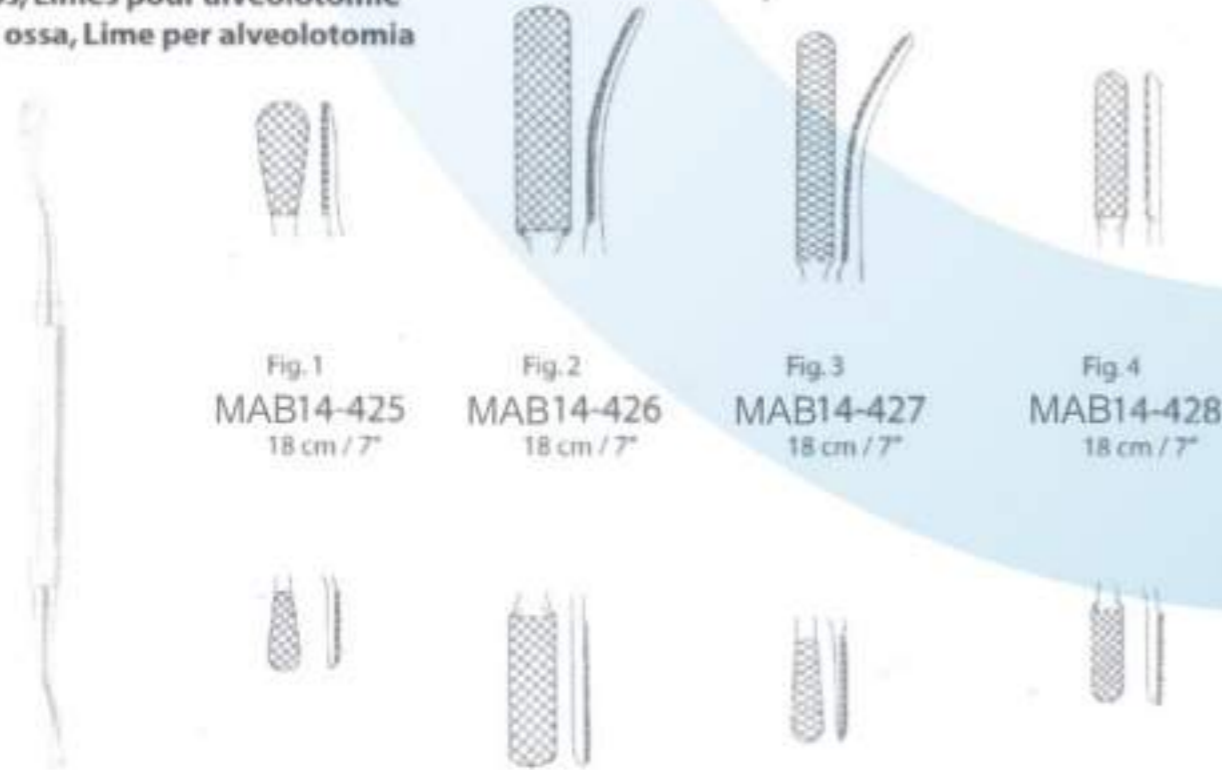

**Fig.1** **MAB14-425** 18 cm / 7"  
**Fig.2** **MAB14-426** 18 cm / 7"  
**Fig.3** **MAB14-427** 18 cm / 7"  
**Fig.4** **MAB14-428** 18 cm / 7"

Miller-Colburn  
 Kreuzhieb  
 cross cut  
 picado en cruz  
 taille croisée  
 tagliente a croce

**TC GOLD**



**MAB14-429** 19 cm / 7 1/2"  
**MAB14-430** 19 cm / 7 1/2"

Miller Miller

**Knochenchirurgie . Chirurgie osseuse . Chirurgia ossea**

**Elevatoren**  
**Elevators**  
**Elevadores**  
**Élévateurs**  
**Elevatori**



**MAB14-431** 19.5 cm / 7 3/4"  
**MAB14-432** 19.5 cm / 7 3/4"  
**MAB-15-433** 17 cm / 6 3/4"  
**MAB14-434** 16 cm / 6 1/4"

Langenbeck



Martin-Langenbeck

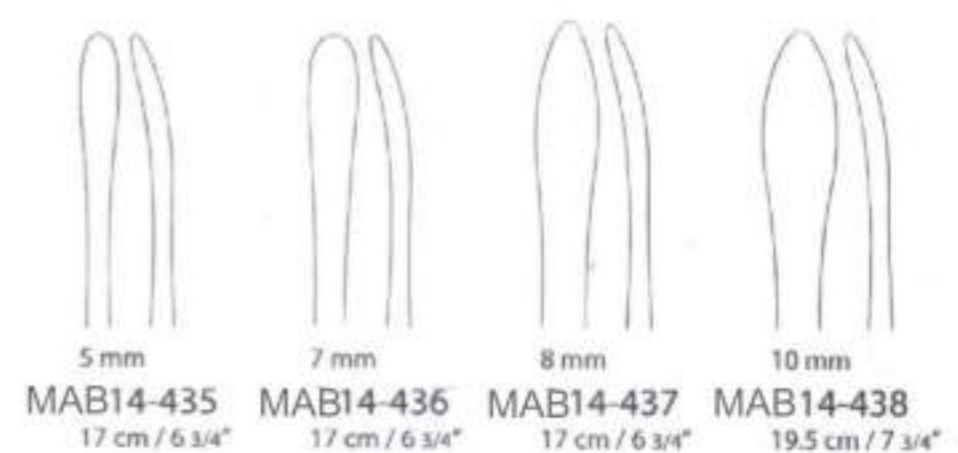

**MAB14-435** 17 cm / 6 3/4"  
**MAB14-436** 17 cm / 6 3/4"  
**MAB14-437** 17 cm / 6 3/4"  
**MAB14-438** 19.5 cm / 7 3/4"

Williger

Williger



**Knochenchirurgie . Bone Surgery . Cirugía ósea**  
**Elevatoren, Doppeldissektoren**  
**Elevators, Dissectors, double-ended**  
**Elevadores, Disectores dobles**  
**Élévateurs, Dissecteurs doubles**  
**Elevatori, Dissettori doppi**

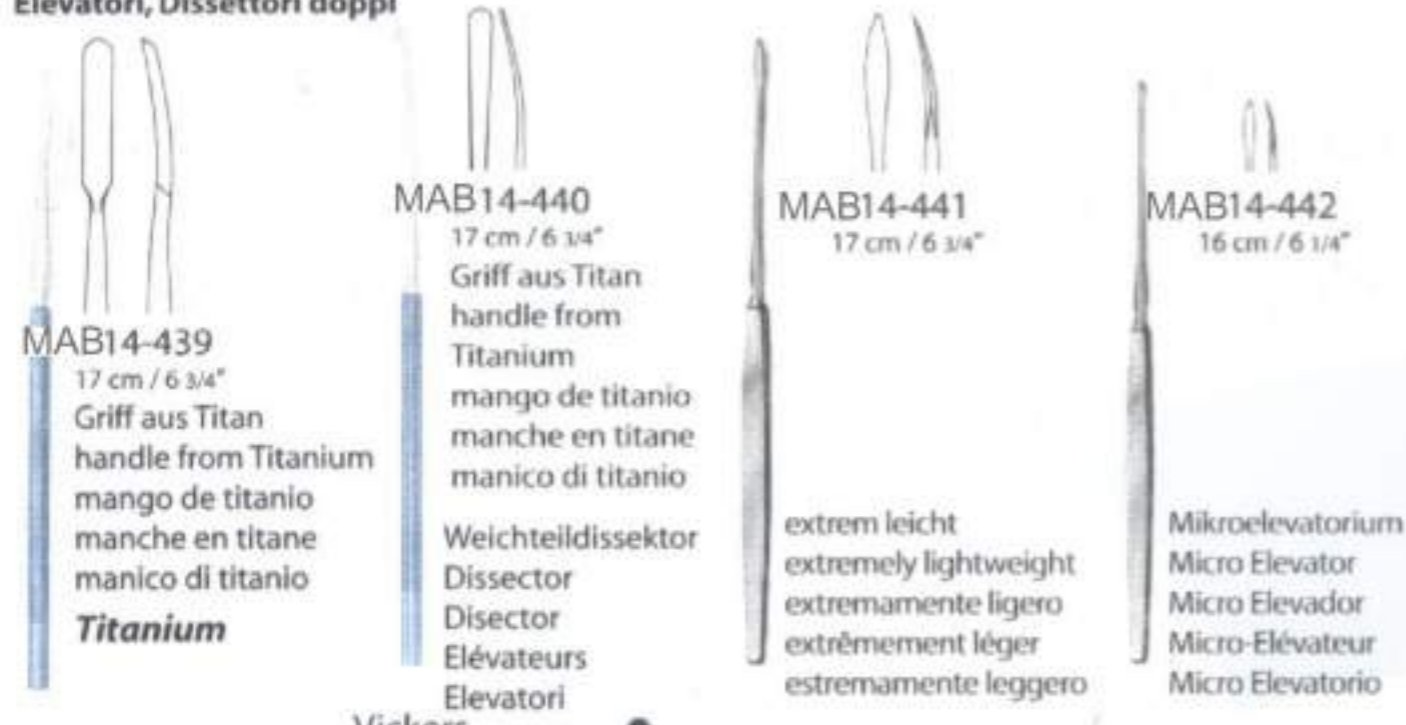

**MAB14-439**  
 17 cm / 6 3/4"  
 Griff aus Titan  
 handle from Titanium  
 mango de titanio  
 manche en titane  
 manico di titanio  
**Titanium**

**MAB14-440**  
 17 cm / 6 3/4"  
 Griff aus Titan  
 handle from Titanium  
 mango de titanio  
 manche en titane  
 manico di titanio  
 Weichteildissektor  
 Dissector  
 Disector  
 Élévateurs  
 Elevatori

**MAB14-441**  
 17 cm / 6 3/4"  
 extrem leicht  
 extremely lightweight  
 estremamente ligero  
 extrêmement léger  
 estremamente leggero

**MAB14-442**  
 16 cm / 6 1/4"  
 Mikroelevatorium  
 Micro Elevator  
 Micro Elevador  
 Micro-Élévateur  
 Micro Elevatorio

Vickers

Vickers



**MAB14-443**  
 16 cm / 6 1/4"  
 Phalangenhebel  
 Phalangeal Elevator  
 Elevador para falanges  
 Élévateur pour phalanges  
 Divaricatore per falanghe



**MAB14-444**  
 21 cm / 8 1/4"

Alderdyce



**MAB14-445**  
 18.5 cm / 7 1/4"

McDonald

**Knochenchirurgie . Chirurgie osseuse . Chirurgia ossea**  
**Knochenhebel**  
**Bone Levers**  
**Elevadores para hueso**  
**Leviers à os**  
**Elevatori per ossa**

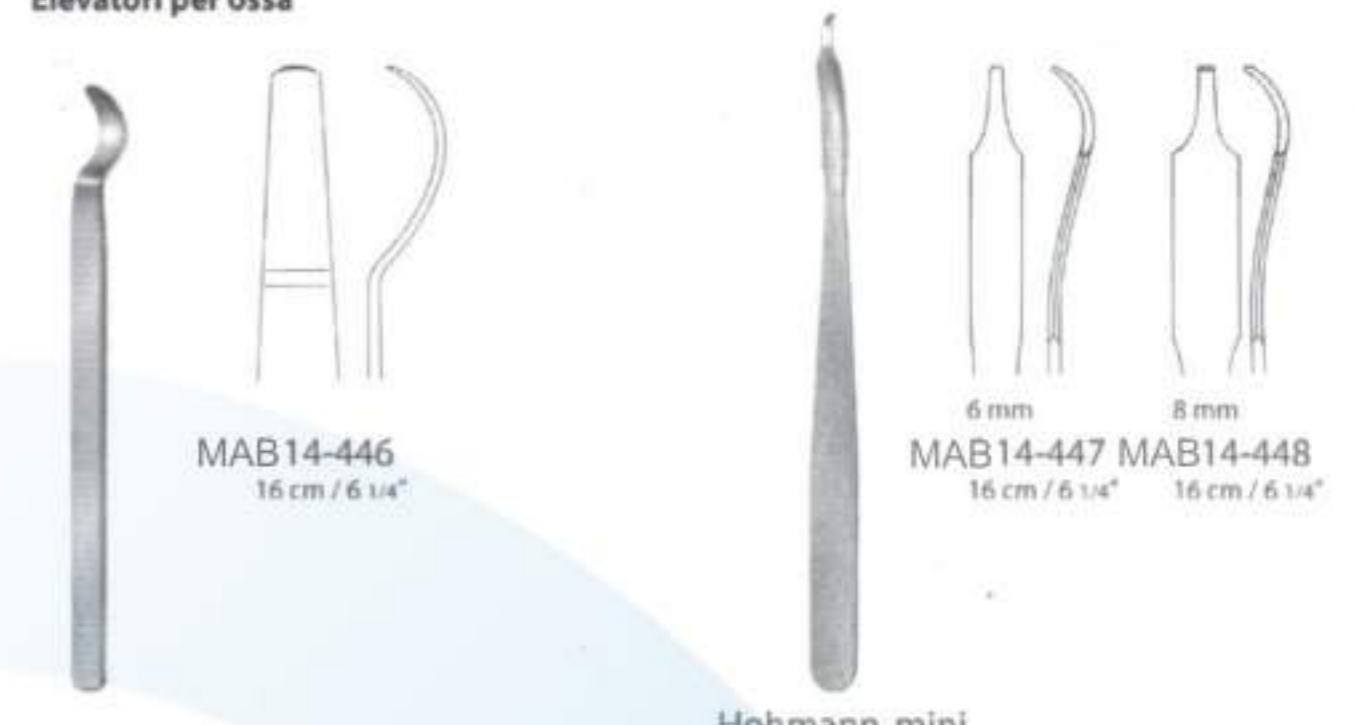

**MAB14-446**  
 16 cm / 6 1/4"

**MAB14-447** **MAB14-448**  
 16 cm / 6 1/4" 16 cm / 6 1/4"

Hohmann, mini



14 mm  
**MAB14-449**  
 16 cm / 6 1/4"



14 mm  
**MAB14-450**  
 12 cm / 4 3/4"

**Knochenchirurgie . Bone Surgery . Cirugía ósea**  
**Knochenhebel**  
**Bone Levers**  
**Elevadores para hueso**  
**Leviers à os**  
**Elevatori per ossa**



**Hohmann**  
**MAB14-451**  
 22 cm / 8 3/4"  
 schmale Spitze  
 narrow tip  
 punta estrecha  
 pointe étroite  
 punta stretta

**Hohmann**  
**MAB14-452**  
 23.5 cm / 9 1/4"  
 schmale Spitze  
 narrow tip  
 punta estrecha  
 pointe étroite  
 punta stretta

**Hohmann**  
**MAB14-453**  
 23.5 cm / 9 1/4"  
 schmale Spitze  
 narrow tip  
 punta estrecha  
 pointe étroite  
 punta stretta

**Hohmann**  
**MAB14-454**  
 25 cm / 9 3/4"  
 schmale Spitze  
 narrow tip  
 punta estrecha  
 pointe étroite  
 punta stretta

**Knochenchirurgie . Chirurgie osseuse . Chirurgia ossea**  
**Knochenhebel**  
**Bone Levers**  
**Elevadores para hueso**  
**Leviers à os**  
**Elevatori per ossa**



**Hohmann**  
**MAB14-455**  
 23.5 cm / 9 1/4"  
 schmale Spitze  
 narrow tip  
 punta estrecha  
 pointe étroite  
 punta stretta

**Hohmann**  
**MAB14-456**  
 25.5 cm / 10"  
 breite Spitze  
 wide tip  
 punta ancha  
 pointe large  
 punta larga

**Hohmann**  
**MAB14-457**  
 29 cm / 11 1/2"  
 breite Spitze  
 wide tip  
 punta ancha  
 pointe large  
 punta larga

**Hohmann**  
**MAB14-458**  
 27.5 cm / 10 3/4"  
 breite, rundes Ende  
 wide, round tip  
 punta ancha, redonda  
 pointe large, ronde  
 punta larga, rotonda

**Landge-Hohmann**  
**MAB14-459**  
 25 cm / 9 3/4"  
 breite Spitze mit Längsrille  
 wide tip with groove  
 punta ancha con ranura  
 pointe large avec rainure  
 punta larga con scanalatura



Knochenchirurgie . Bone Surgery . Cirugía ósea  
 Knochenhebel  
 Bone Levers  
 Elevadores para hueso  
 Leviers à os  
 Elevatori per ossa

Knochenchirurgie . Chirurgie osseuse . Chirurgia ossea  
 Kniehaken, Spinalhaken  
 Knee Retractors, Spinal Retractors  
 Separadores para rodilla, Separadores espinales  
 Ecarteurs pour le genou, Ecarteurs spinaux  
 Divaricatori per il ginocchio, Divaricatori spinali

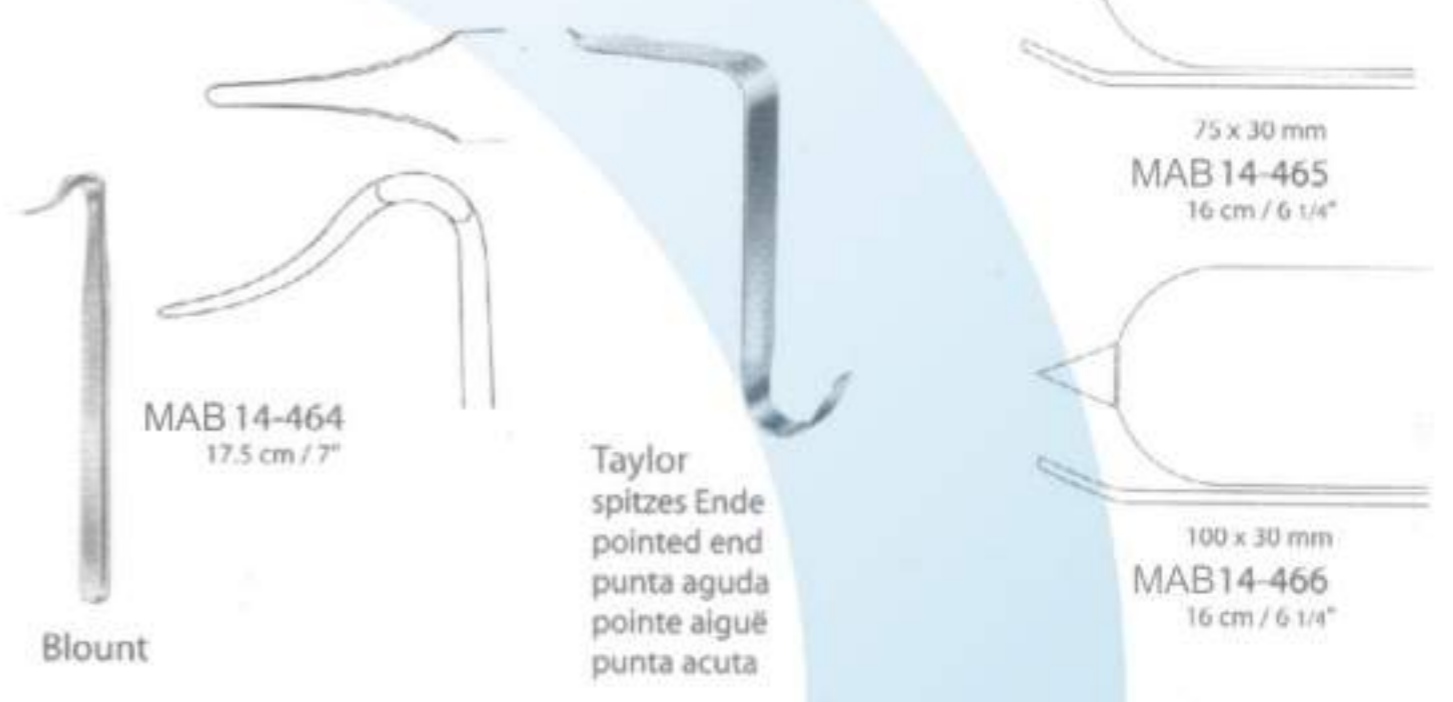
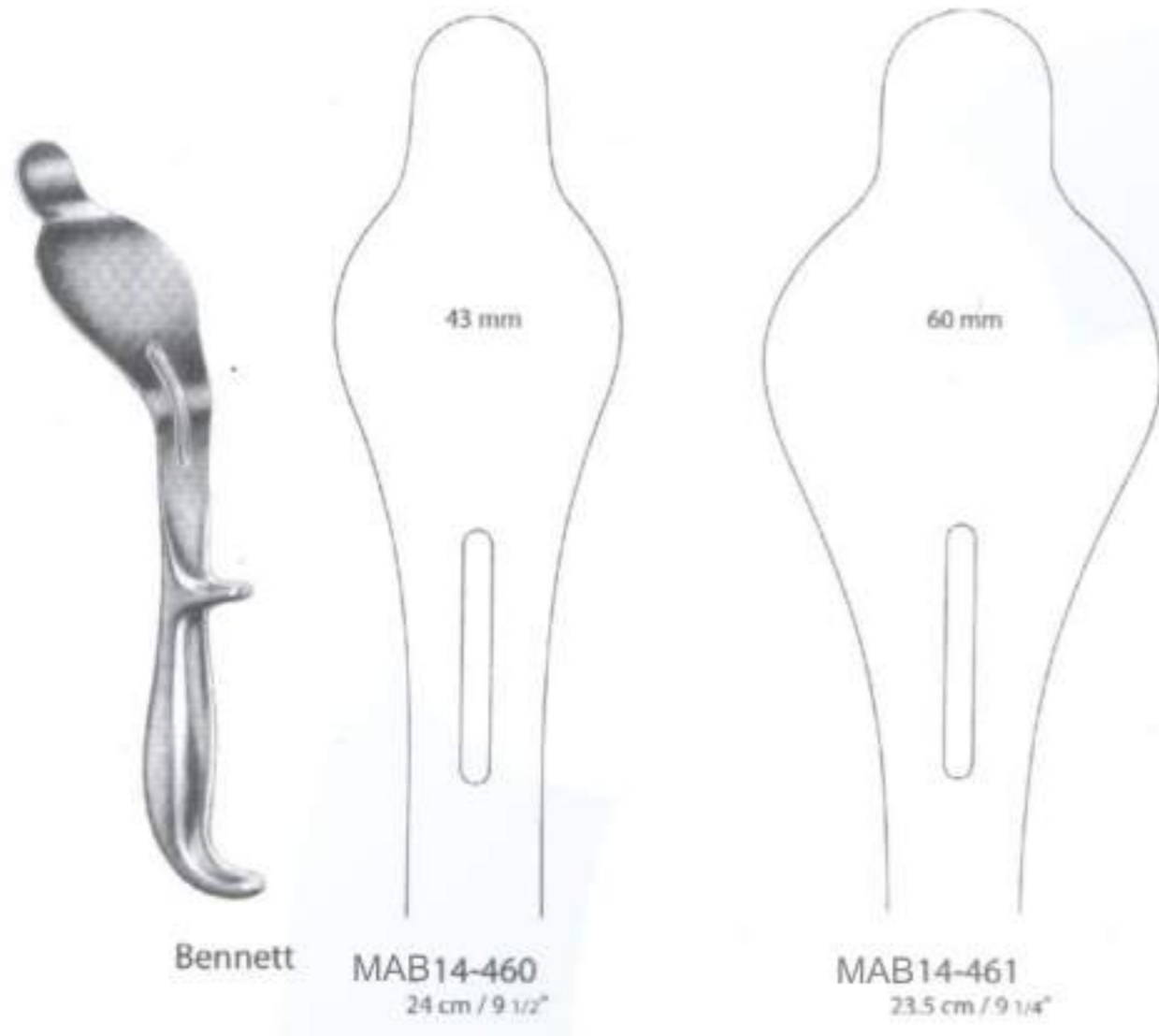

Knochenchirurgie . Bone Surgery . Cirugía ósea  
 Meniskotome, Meniskusmesser  
 Meniscus Knives  
 Cuchillos para menisco  
 Bistouris à ménisque  
 Meniscotomi

Knochenchirurgie . Chirurgie osseuse . Chirurgia ossea  
 Sehnenstripper  
 Tendon Strippers  
 Enucleadores de tendones  
 Instruments à écorcher les tendons  
 Scollatendini

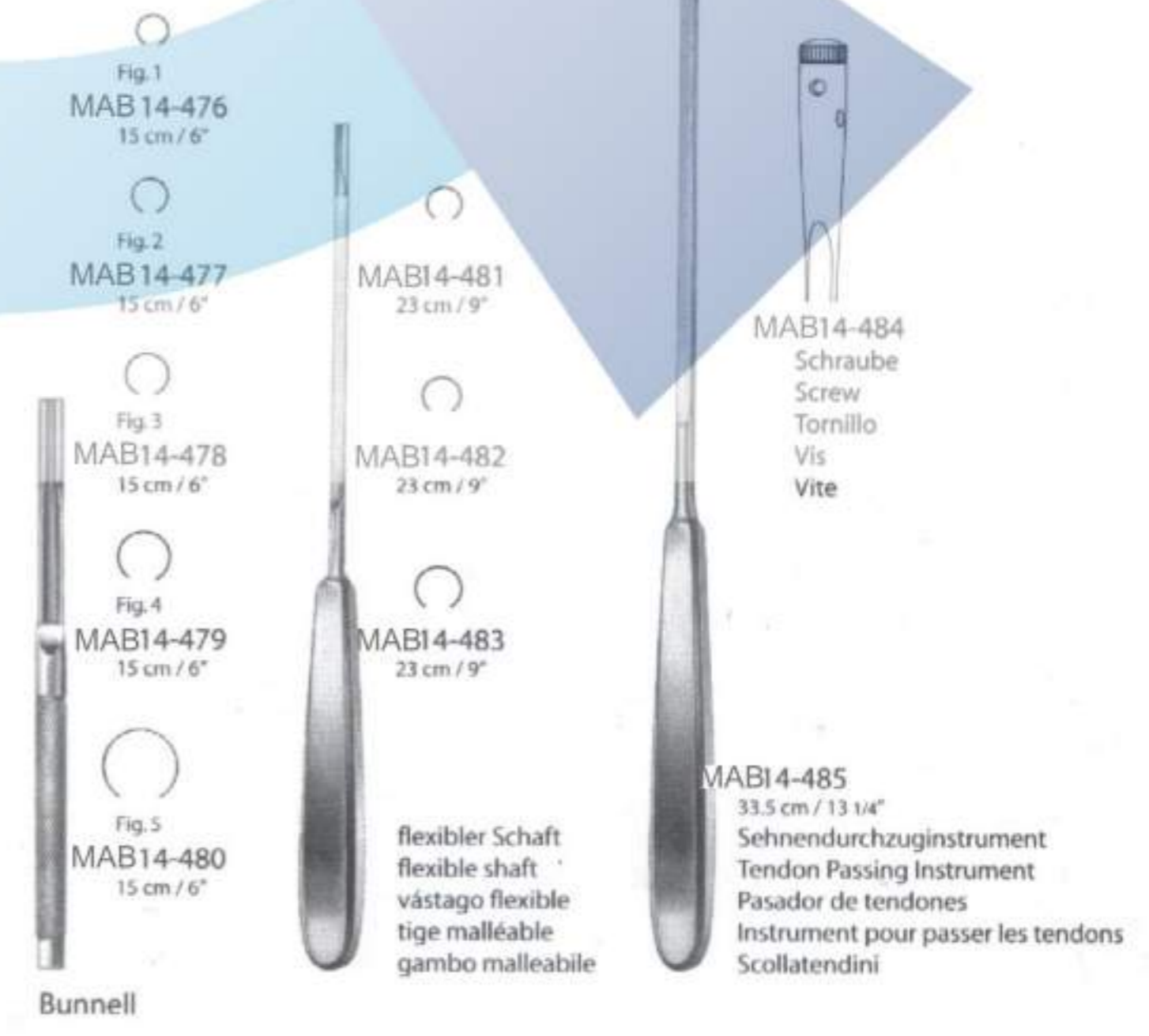



**Knochenchirurgie . Bone Surgery . Cirugía ósea**  
**Sehnenstripper**  
**Tendon Strippers**  
**Enucleadores de tendones**  
**Instruments à écorcher les tendons**  
**Scollatendini**

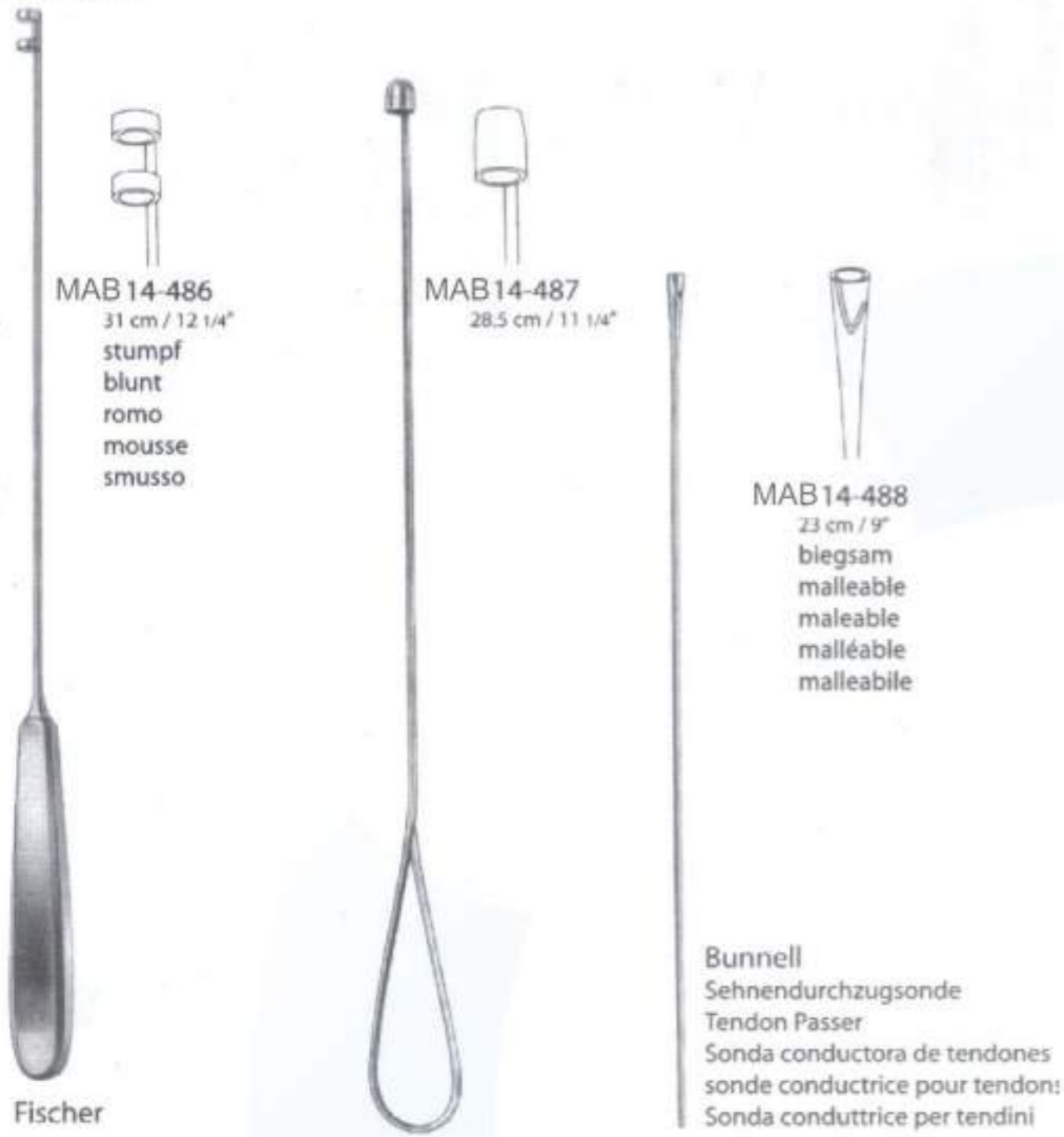

**Knochenchirurgie . Chirurgie osseuse . Chirurgia ossea**  
**Sehnenfasszangen, Sehrendurchzugzangen**  
**Tendon Holding Forceps, Tendon Tunnelling Forceps**  
**Pinzas para coger tendones, Pinzas para pasar tendones**  
**Pinces pour saisir les tendons, Pinces pour passer les tendons**  
**Pinze per afferrare tendini, Pinze passa-tendini**

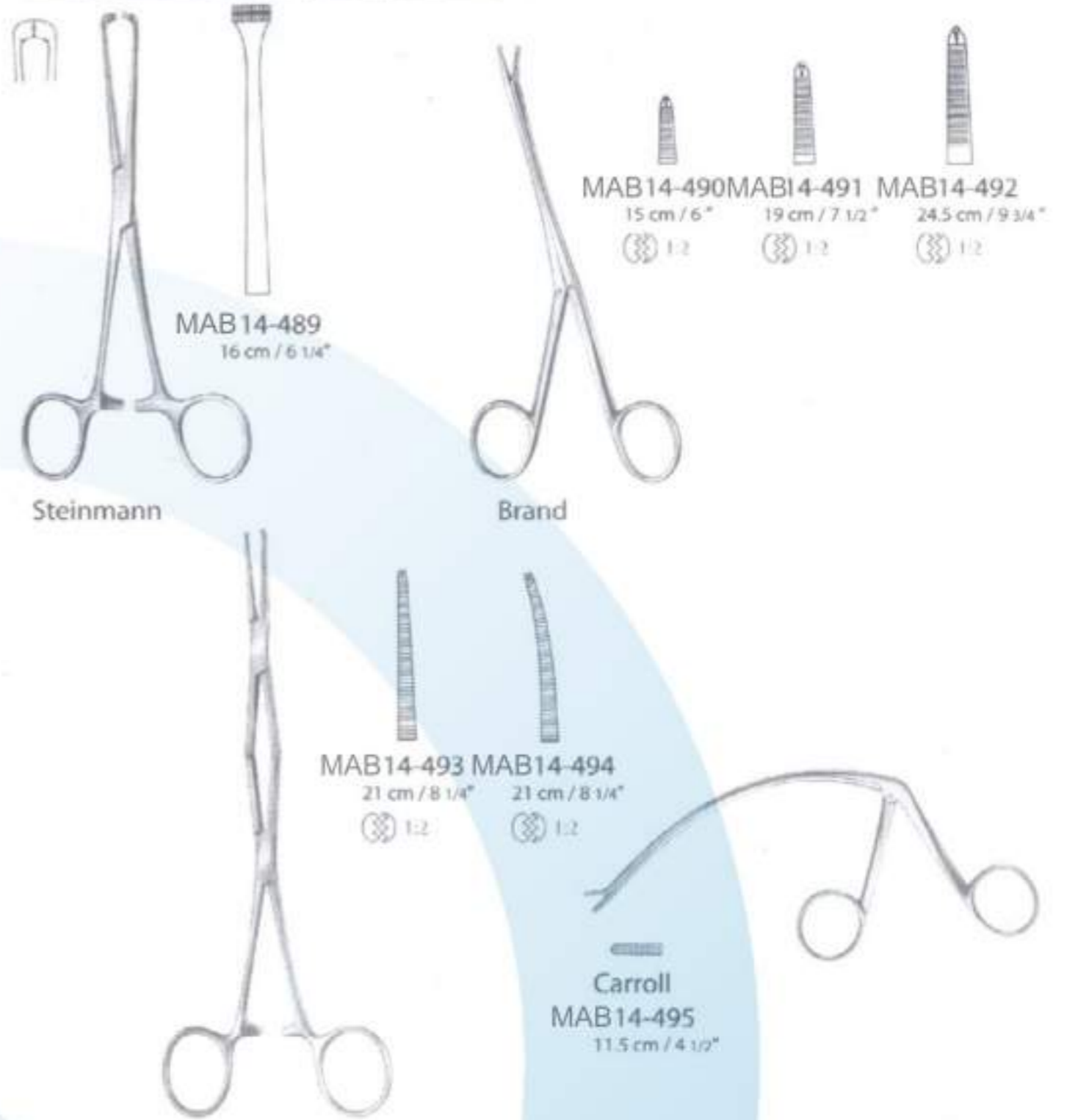

**Knochenchirurgie . Bone Surgery . Cirugía ósea**  
**Sehnenfasszangen, Sehnenflechtzangen**  
**Tendon Holding Forceps, Tendon Interlacing Forceps**  
**Pinzas para coger tendones, Pinzas para entrelazar tendones**  
**Pinces pour saisir les tendons, Pinces pour entrelacer les tendons**  
**Pinze per afferrare tendini, Pinze per allacciare tendini**

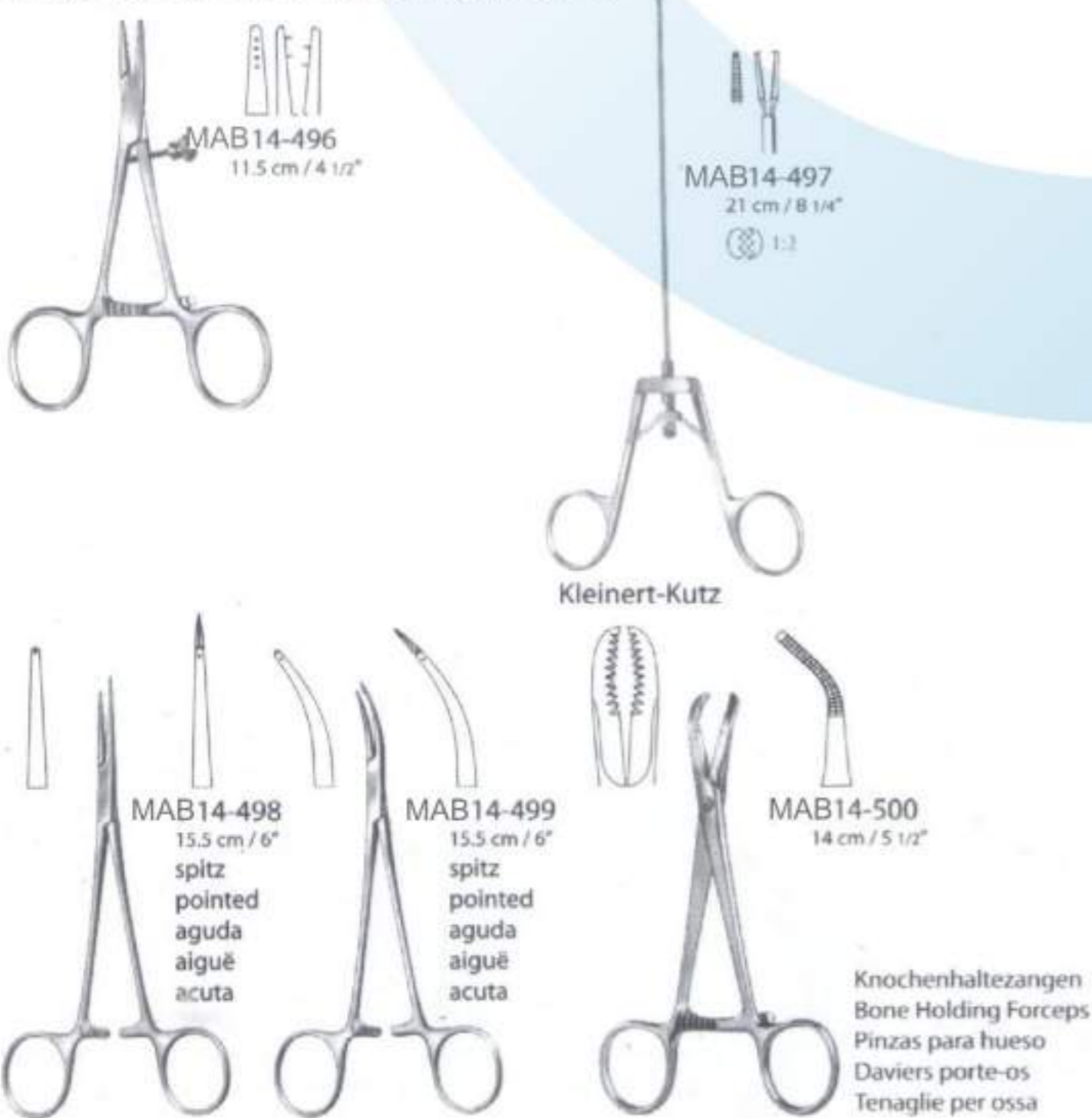

**Knochenchirurgie . Chirurgie osseuse . Chirurgia ossea**  
**Knorpelfasszangen**  
**Cartilage Seizing Forceps**  
**Pinzas para cartilago**  
**Pinces à cartilage**  
**Pinze per cartilagine**

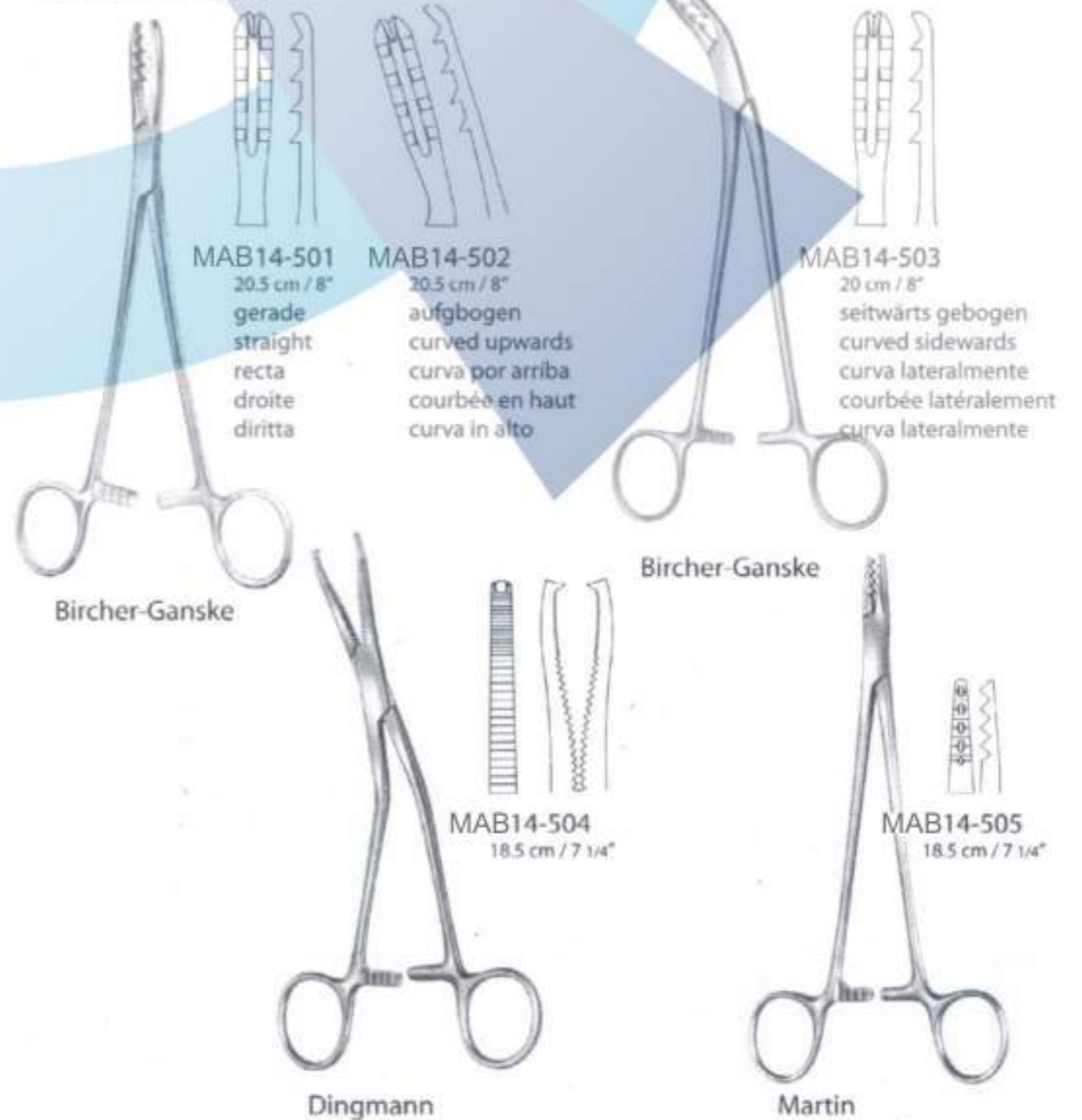



**Knochenchirurgie . Bone Surgery . Cirugía ósea**  
**Repositionszangen, Knochenhalte-zangen**  
**Reposition Forceps, Bone Holding Forceps**  
**Pinzas para reducción, Pinzas para hueso**  
**Pinces à réduction, Daviers porte-os**  
**Pinze per riposizioni, Tenaglie per ossa**



**MAB14-506**  
 13.5 cm / 5 1/4"  
 lange Sperre  
 long ratchet  
 cremallera larga  
 cremaillère longue  
 cremagliera lunga  
 scharf  
 pointed  
 aguda  
 aiguë  
 acuta



Lewin



**MAB14-507**  
 18.5 cm / 7 1/4"

**Knochenchirurgie . Chirurgie osseuse . Chirurgia ossea**  
**Knochenhalte-zangen, Knochenfasszange, Repositionszangen**  
**Bone Holding Forceps, Reposition Forceps**  
**Pinzas para hueso, Pinzas para reposición**  
**Daviers porte-os, Pinces à réduction**  
**Tenaglie per ossa, Pinze per riposizioni**



**MAB14-511**  
 21 cm / 8 1/4"  
 Kräftiges Modell  
 heavy pattern  
 modelo fuerte  
 modèle fort  
 modello forte

Fergusson

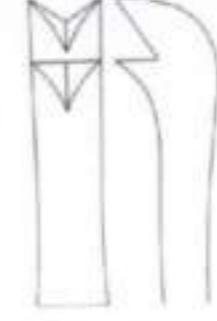

Frosch



**MAB14-512**  
 18 cm / 7"



**MAB14-513**  
 20 cm / 8"



**MAB14-508**  
 14 cm / 5 1/2"  
 grazil  
 delicate  
 delicada  
 gracile  
 sottile



**MAB14-509**  
 15 cm / 6"  
 lange Sperre  
 long ratchet  
 cremallera larga  
 cremaillère longue  
 cremagliera lunga  
 scharf  
 pointed  
 aguda  
 aiguë  
 acuta



**MAB14-510**  
 21 cm / 8 1/4"

Langenbeck



**MAB14-514**  
 17 cm / 6 3/4"  
 mit Gewindesperre  
 with thread fixation  
 con cremallera de rosca  
 avec cremaillère filetée  
 con cremagliera a filettatura



**MAB14-515**  
 24 cm / 9 1/2"  
 mit Gewindesperre  
 with thread fixation  
 con cremallera de rosca  
 avec cremaillère filetée  
 con cremagliera a filettatura

**Knochenchirurgie . Bone Surgery . Cirugía ósea**  
**knochenhalte-zangen**  
**Bone Holding Forceps**  
**Pinzas para hueso**  
**Daviers porte-os**  
**Tenaglie per ossa**



Kern

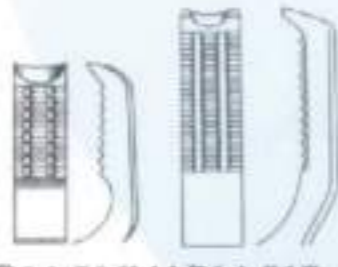

**MAB14-516**  
 17 cm / 6 3/4"



Semb



**MAB14-518**  
 19 cm / 7 1/2"  
 seitwärts gebogen  
 curved sideways  
 curva lateralmente  
 courbée latéralement  
 curva lateralmente

**Knochenchirurgie . Bone Surgery . Cirugía ósea**  
**Knochenhalte-zangen**  
**Bone Holding Forceps**  
**Pinzas para hueso**  
**Daviers porte-os**  
**Tenaglie per ossa**



**MAB14-522**  
 23 cm / 9"



**MAB14-523**  
 25 cm / 9 3/4"



**MAB14-524**  
 28 cm / 11"



**Ulrich**  
 mit Gewindesperre  
 with thread fixation  
 con cremallera de rosca  
 avec cremaillère filetée  
 con cremagliera a filettatura



**MAB14-525**  
 22 cm / 8 3/4"



**MAB14-526**  
 24 cm / 9 1/2"



**MAB14-527**  
 27 cm / 10 3/4"



**Ulrich**  
 mit Gewindesperre  
 with thread fixation  
 con cremallera de rosca  
 avec cremaillère filetée  
 con cremagliera a filettatura



**MAB14-519**  
 23 cm / 9"

**MAB14-520**  
 26 cm / 10 1/4"

Farabeuf



**MAB14-521**  
 26 cm / 10 1/4"

Farabeuf

**Knochenchirurgie . Chirurgie osseuse . Chirurgia ossea**  
**Knochenhalte-zangen**  
**Bone Holding Forceps**  
**Pinzas para hueso**  
**Daviers porte-os**  
**Tenaglie per ossa**



Knochenchirurgie . Chirurgie osseuse . Chirurgia ossea  
 Knochenhalteanzgen  
 Bone Holding Forceps  
 Pinzas para hueso  
 Daviers porte-os  
 Tenaglie per ossa

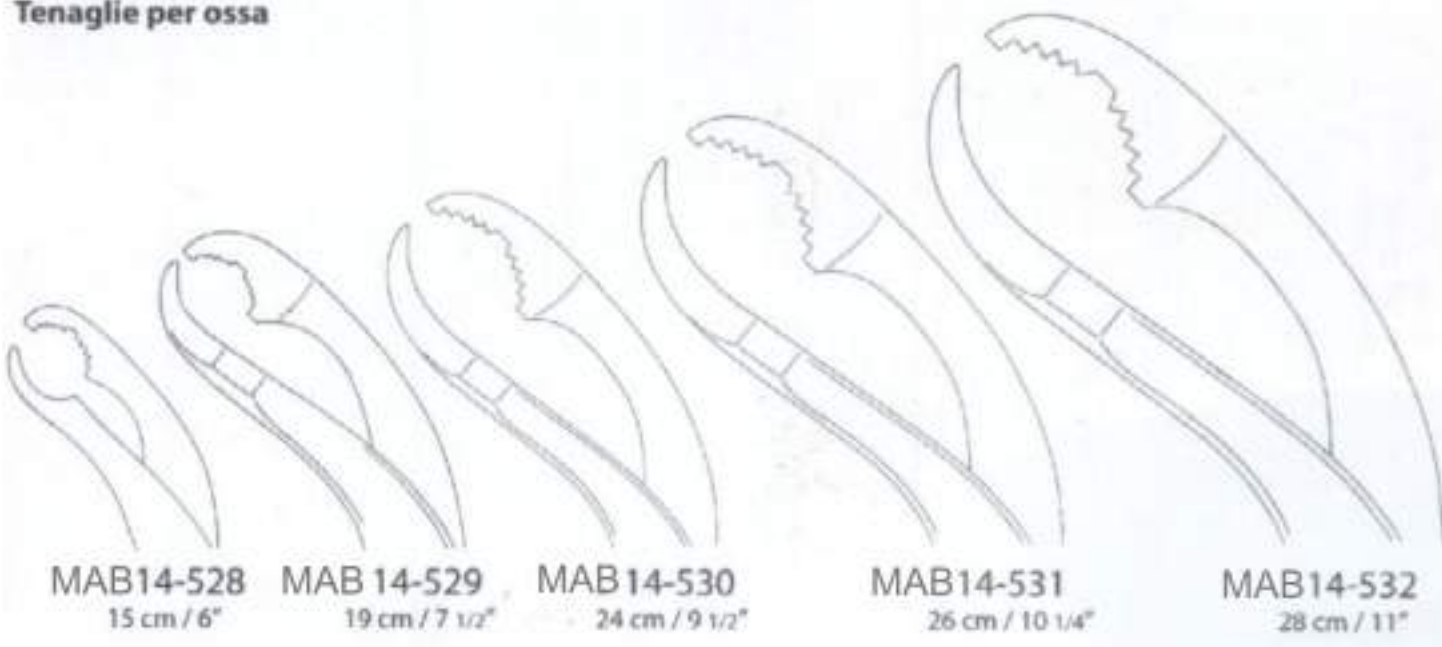

MAB14-528 15 cm / 6"  
 MAB 14-529 19 cm / 7 1/2"  
 MAB14-530 24 cm / 9 1/2"  
 MAB14-531 26 cm / 10 1/4"  
 MAB14-532 28 cm / 11"



selbstzentrierend  
 mit Gewindesperre  
 self-centering  
 with thread fixation  
 autocentrante  
 avec cremallera de rosca  
 à centrage automatique  
 avec cremallère filetée  
 centraggio automatico  
 con cremagliera a filettatura

Knochenchirurgie . Bone Surgery . Cirugia ósea  
 Knochenhalteanzgen  
 Bone Holding Forceps  
 Pinzas para hueso  
 Daviers porte-os  
 Tenaglie per ossa

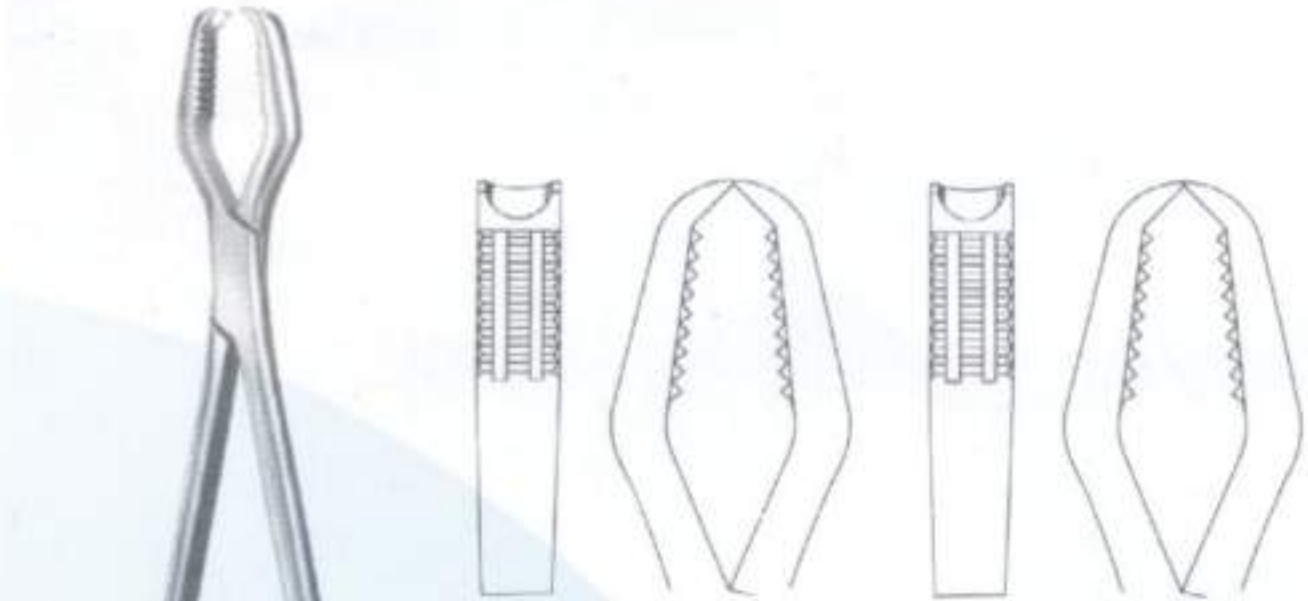

MAB14-533  
 33 cm / 13"  
 ohne Sperre  
 without ratchet  
 sin cremallera  
 sans cremallère  
 senza cremagliera

MAB 14-534  
 33 cm / 13"  
 mit Sperre  
 with ratchet  
 con cremallera  
 avec cremallère  
 con cremagliera

Lane

Knochenchirurgie . Chirurgie osseuse . Chirurgia ossea  
 Knochenhalteanzgen, Amputationsschild  
 Bone Holding Forceps, Amputation Retractor  
 Pinzas para hueso, Retractor para amputación  
 Daviers porte-os, Retracteur pour amputation  
 Tenaglie per ossa, Retrattore per amputazione



MAB 14-535 25 cm / 9 3/4"  
 MAB14-536 26 cm / 10 1/4"  
 MAB14-537 27 cm / 10 3/4"

Verbrugge



MAB14-538  
 17.5 cm / 7"

Verbrugge



Percy  
 MAB14-539  
 auseinandernehmbar  
 detachable  
 desmontable  
 démontable  
 smontabile

Knochenchirurgie . Bone Surgery . Cirugia ósea  
 Hohlmeißelanzgen  
 Bone Rongeurs  
 Pinzas gubias  
 Pincas-gouges  
 Pinze-sgorbie

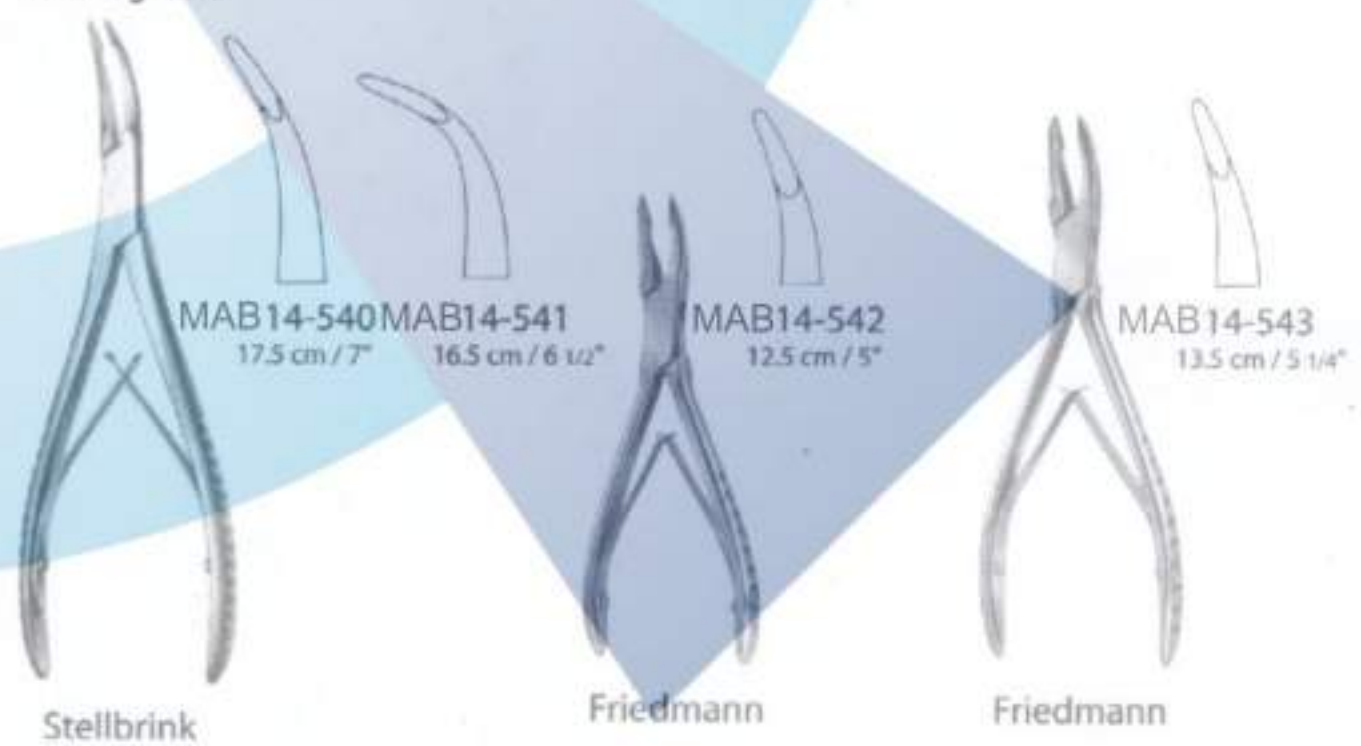

MAB14-540 17.5 cm / 7"  
 MAB14-541 16.5 cm / 6 1/2"  
 MAB14-542 12.5 cm / 5"  
 MAB14-543 13.5 cm / 5 1/4"

Stellbrink

Friedmann

Friedmann



MAB14-544 13.5 cm / 5 1/4"  
 MAB14-545 13.5 cm / 5 1/4"  
 MAB14-546 16.5 cm / 6 1/2"  
 MAB14-547 16.5 cm / 6 1/2"

Friedmann

Cleveland

Cleveland

Mead



Knochenchirurgie . Chirurgie osseuse . Chirurgia ossea  
 Hohlmeißelzangen  
 Bone Rongeurs  
 Pinzas gubias  
 Pincas-gouges  
 Pinze-sgorbie



MAB14-548  
17.5 cm / 7"

Hartmann



Jansen

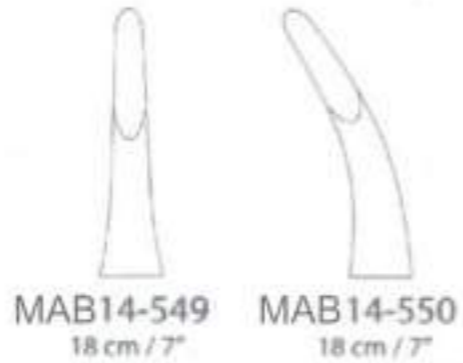

MAB14-549 18 cm / 7" MAB14-550 18 cm / 7"

Knochenchirurgie . Bone Surgery . Cirugia ósea  
 Hohlmeißelzangen  
 Bone Rongeurs  
 Pinzas gubias  
 Pincas-gouges  
 Pinze-sgorbie



Luer

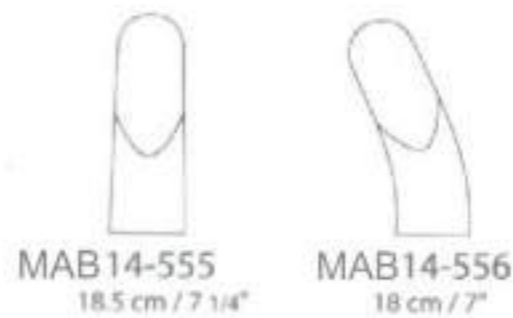

MAB14-555 18.5 cm / 7 1/4" MAB14-556 18 cm / 7"



Lempert



Blumenthal



MAB14-552 15 cm / 6" MAB14-553 15 cm / 6" MAB14-554 14 cm / 5 1/2"



Luer



MAB14-557 14.5 cm / 5 3/4" MAB14-558 14.5 cm / 5 3/4" MAB14-559 14.5 cm / 5 3/4"

Knochenchirurgie . Chirurgie osseuse . Chirurgia ossea  
 Hohlmeißelzangen  
 Bone Rongeurs  
 Pinzas gubias  
 Pincas-gouges  
 Pinze-sgorbie



Böhler



MAB14-560 15.5 cm / 6" MAB14-561 15.5 cm / 6"



Beyer



MAB14-562 18 cm / 7"



Zaufal-Jansen



MAB14-563 18 cm / 7"

Knochenchirurgie . Bone Surgery . Cirugia ósea  
 Hohlmeißelzangen  
 Bone Rongeurs  
 Pinzas gubias  
 Pincas-gouges  
 Pinze-sgorbie



Semb



MAB14-568 23.5 cm / 9 1/4"



Stille



MAB14-569 22.5 cm / 8 3/4"



Mayfield



Marquard



MAB14-565 20.5 cm / 8"



Ruskin



MAB14-566 19 cm / 7 1/2"



Ruskin



MAB14-567 24 cm / 9 1/2"



Echlin



MAB14-570 23 cm / 9" MAB14-571 23 cm / 9" MAB14-572 23 cm / 9"



Stille-Ruskin

MAB14-573 23.5 cm / 9 1/4"



Knochenchirurgie . Chirurgie osseuse . Chirurgia ossea  
 Hohlmeißelzangen  
 Bone Rongeurs  
 Pinzas gubias  
 Pincis-gouges  
 Pinze-sgorbie

Knochenchirurgie . Bone Surgery . Cirugía ósea  
 Hohlmeißelzangen  
 Bone Rongeurs  
 Pinzas gubias  
 Pincis-gouges  
 Pinze-sgorbie



Knochenchirurgie . Chirurgie osseuse . Chirurgia ossea  
 Knochen splitterzangen  
 Bone Cutting Forceps  
 Pinzas cortantes para hueso  
 Pincis coupantes à os  
 Cesioie per ossa

Knochenchirurgie . Bone Surgery . Cirugía ósea  
 Knochen splitterzangen  
 Bone Cutting Forceps  
 Pinzas cortantes para hueso  
 Pincis coupantes à os  
 Cesioie per ossa

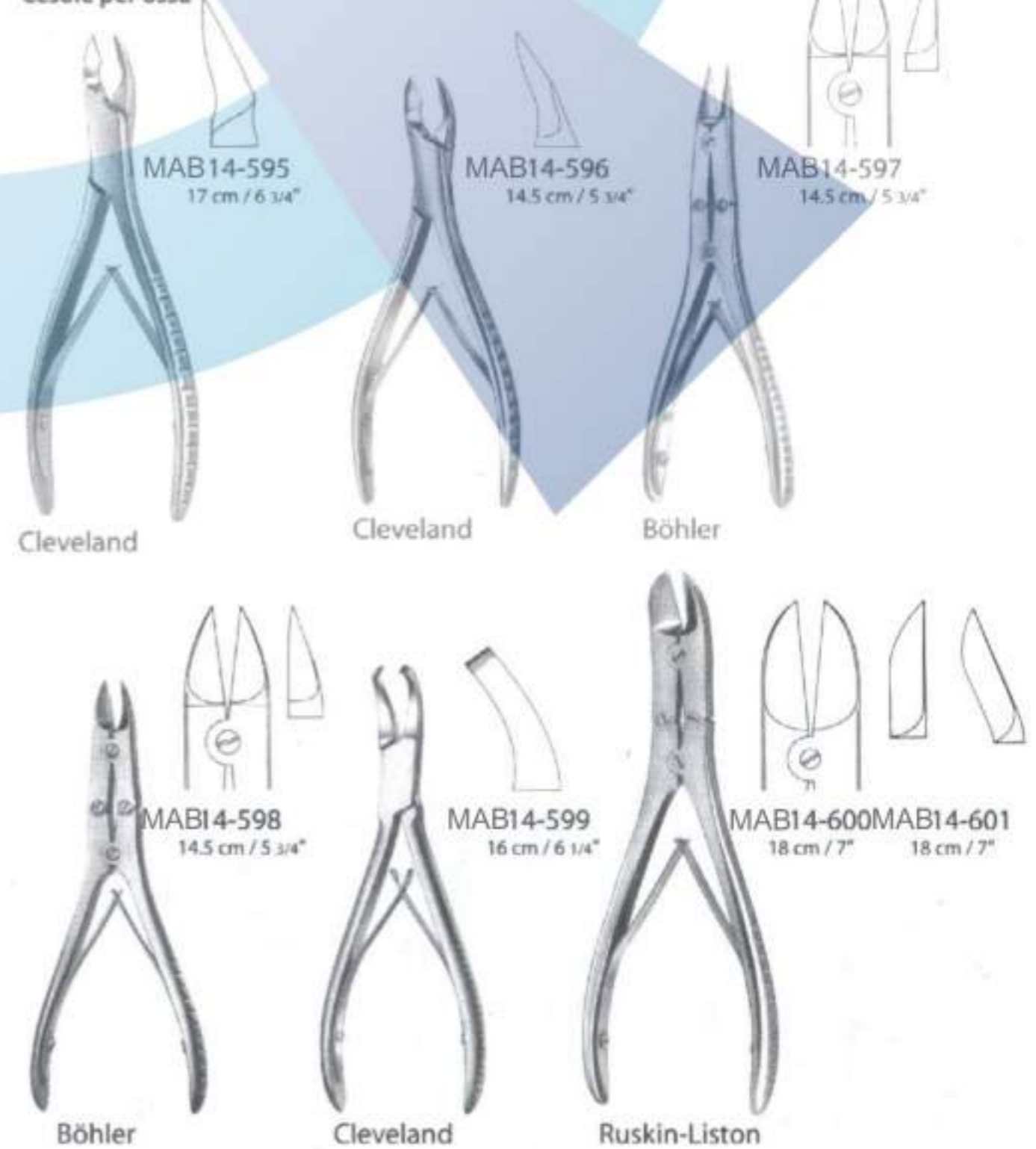



Knochenchirurgie . Chirurgie osseuse . Chirurgia ossea  
 Knochensplitterzangen  
 Bone Cutting Forceps  
 Pinzas cortantes para hueso  
 Pincas coupantes à os  
 Cesioie per ossa

Knochenchirurgie . Bone Surgery . Cirugia ósea  
 Knochensplitterzangen  
 Bone Cutting Forceps  
 Pinzas cortantes para hueso  
 Pincas coupantes à os  
 Cesioie per ossa

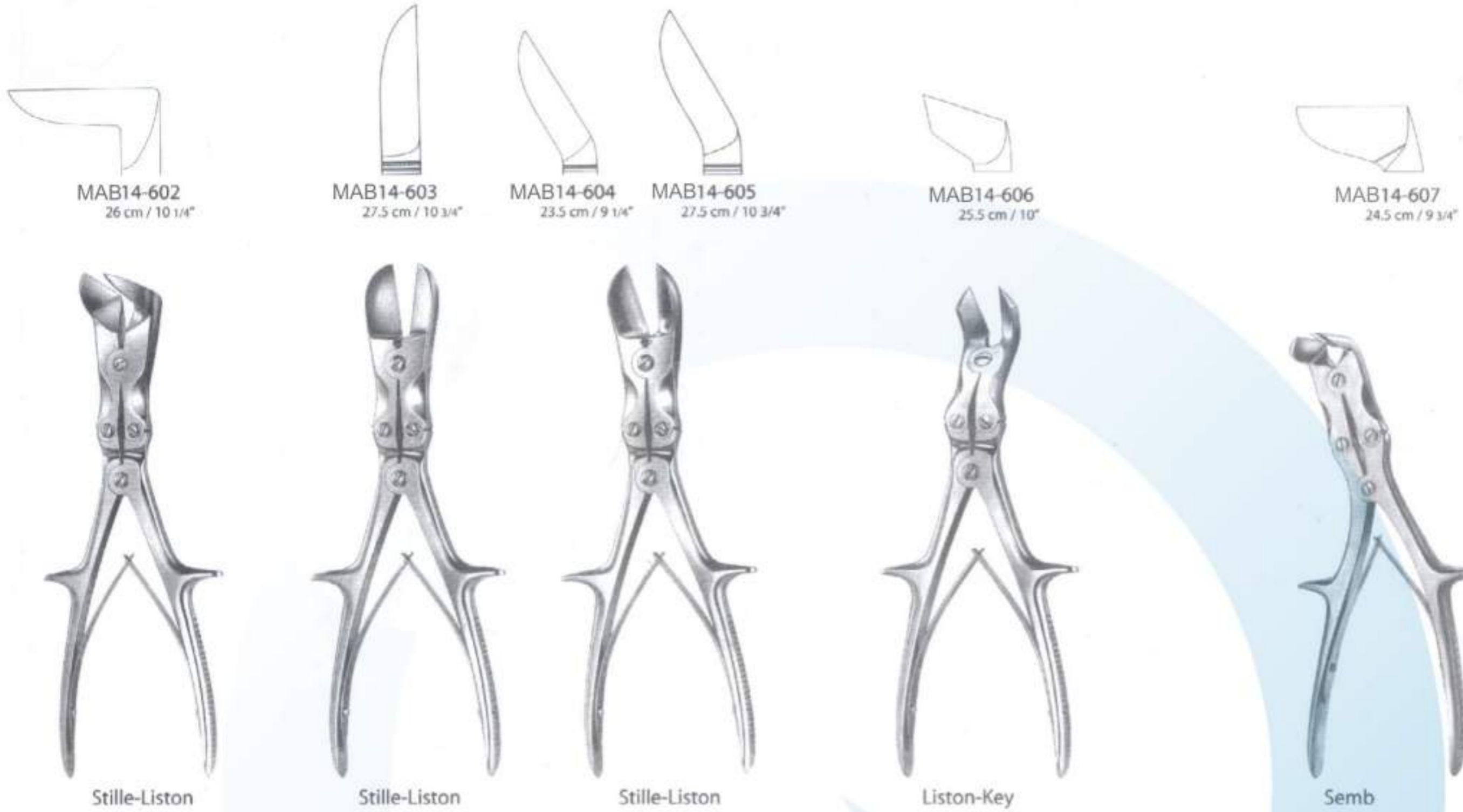

Knochenchirurgie . Bone Surgery . Cirugia ósea  
 Bleihände, Kompressorium, Fingernagelbohrer  
 Lead Hands, Tourniquet, Finger Nail Drill  
 Manoplas de plomo, compresor, Perforador para uñas  
 Manches en plomb, Compresseur, Perforateur à ongles  
 Mani di piombo, compressorio, Perforatore per unghie

Knochenchirurgie . Chirurgie osseuse . Chirurgia ossea  
 Fingerringssägen, Nagelextraktionszangen  
 Finger Ring Saws, Nail Extracting Forceps  
 Sierras para abrir anillos, Pinzas para arancar uñas  
 Scies pour couper les bagues, Pincas pour extraire les ongles  
 Seghe per anelli, Pinze per la lacerazione delle unghie

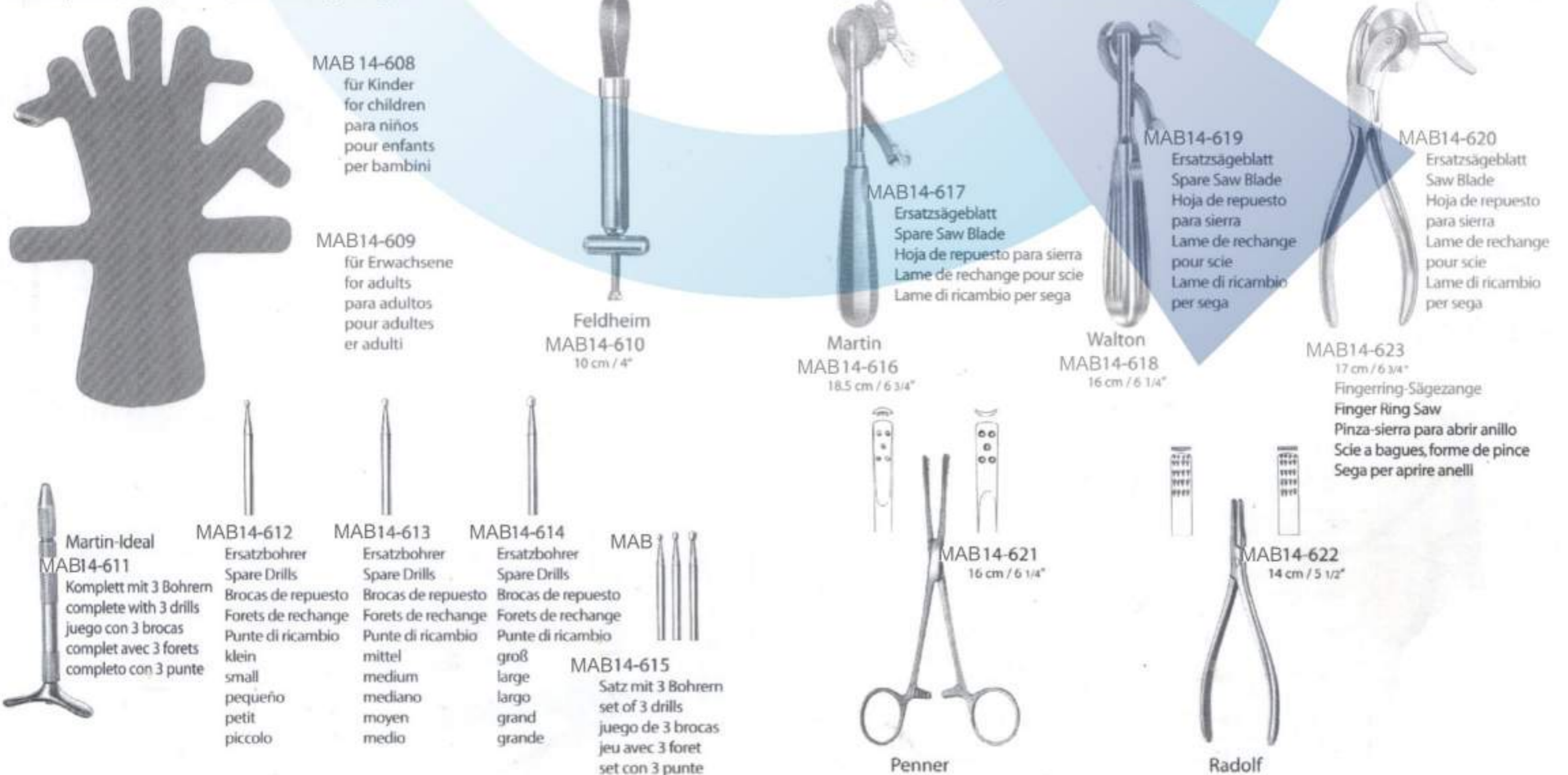



## MAB 15

Herz-u.Gefäßchirurgie  
 Cardiovascular Surgery  
 Cirugia Cardiovascular  
 Chirurgie cardio-vasculaire  
 Chirurgia cardiovascolare



Herz- u. Gefäßchirurgie . Cardiovascular Surgery. Cirugia cardiovascular  
 Rippenscheren  
 Rib Shears  
 Costótomos  
 Costotomes  
 Costotomi



ziehender Schnitt  
 drawing cut  
 corte oblicuo  
 lame glissante  
 lama di retroazione

**MAB15-001**  
 23 cm / 9"  
 Knochenschere  
 Bone Shears  
 Cizallas para hueso  
 Cisaillies à os  
 Cesoaia per ossa

**MAB15-002**  
 23 cm / 9"

Gluck  
**MAB15-003**  
 21 cm / 8 1/4"

Herz- u. Gefäßchirurgie . Chirurgie cardio-vasculaire . Chirurgia cardiovascolare  
 Rippenscheren, Sternummeißel  
 Rib Shears, Sternum Chisel  
 Costótomos, Cinceles  
 Costotomes, Ciseau-burin à sternum  
 Costotomi, Scalpello per sterno



Sauerbruch  
**MAB15-004**  
 26 cm / 10 1/4"



Giertz-Stille  
**MAB15-005**  
 24.5 cm / 9 3/4"

Herz- u. Gefäßchirurgie . Cardiovascular Surgery . Cirugia cardiovascular  
 Rippensperrer  
 Rib Retractors  
 Separadores costales  
 Ecarteurs des côtes  
 Divaricatori costali



Cooley  
 für Säuglinge  
 for babies  
 para recién nacidos  
 pour nourissons  
 per neonati  
**MAB15-009**

Seitenvalven  
 lateral blades  
 hojas laterales  
 valves latérales  
 valve laterali

Spreizweite  
 spreading  
 abertura  
 ouverture  
 apertura

12 x 16 mm

95 mm



Cooley  
 für Kinder  
 for children  
 para niños  
 pour enfants  
 per bambini  
**MAB15-010**  
**MAB15-011**

Seitenvalven  
 lateral blades  
 hojas laterales  
 valves latérales  
 valve laterali

Spreizweite  
 spreading  
 abertura  
 ouverture  
 apertura

15 x 30 mm

140 mm

21 x 44 mm

150 mm



Cooley  
 für Erwachsene  
 for adults  
 para adultos  
 pour adultes  
 per adulti  
**MAB15-012**

Seitenvalven  
 lateral blades  
 hojas laterales  
 valves latérales  
 valve laterali

Spreizweite  
 spreading  
 abertura  
 ouverture  
 apertura

35 x 50 mm

200 mm



Brunner  
**MAB15-006**  
 32 cm / 12 1/2"  
 für die rechte Hand  
 for right hand  
 para la mano derecha  
 pour la main droite  
 per la mano destra

**MAB15-007**  
 32 cm / 12 1/2"  
 für die linke Hand  
 for left hand  
 para la mano izquierda  
 pour la main gauche  
 per la mano sinistra



Lebsche  
**MAB15-008**  
 24.5 cm / 9 3/4"



Herz- u. Gefäßchirurgie . Chirurgie cardio-vasculaire . Chirurgia cardiovascolare  
 Rippensperrer  
 Rib Retractors  
 Separadores costales  
 Ecarteurs des côtes  
 Divaricatori costali



Finochietto, Infant  
 für Säuglinge  
 for babies  
 para recién nacidos  
 pour nourissons  
 per neonati

Seitenvalven lateral blades hojas laterales valves latérales valve laterli	15 x 15 mm	Spreizweite spreading abertura ouverture apertura	75 mm
--	------------	---	-------



Finochietto, Baby  
 für Kinder  
 for children  
 para niños  
 pour enfants  
 per bambini

Seitenvalven lateral blades hojas laterales valves latérales valve laterli	31 x 31 mm	Spreizweite spreading abertura ouverture apertura	100 mm
--	------------	---	--------



Finochietto

Seitenvalven lateral blades hojas laterales valves latérales valve laterli	40 x 45 mm	Spreizweite spreading abertura ouverture apertura	135 mm
	52 x 62 mm		175 mm
	85 x 65 mm		175 mm

Herz- u. Gefäßchirurgie . cardiovascular Surgery . Cirugia cardiovascular  
 Rippensperrer  
 Rib Retractors  
 Separadores costales  
 Ecarteurs des côtes  
 Divaricatori costali

Burford

mit 2 Paar Valven with 2 pairs of blades con 2 pares de valvas avec 2 paies de valves con 2 paia di valve	Spreizweite spreading abertura ouverture apertura	
MAB15-018	47 x 62 mm + 65 x 62 mm	200 mm
MAB15-019	47 x 62 mm + 65 x 62 mm	260 mm
MAB15-020	47 x 62 mm + 65 x 62 mm	300 mm



Herz- u. Gefäßchirurgie . Chirurgie cardio-vasculaire . Chirurgia cardiovascolare  
 Rippensperrer  
 Rib Retractors  
 Separadores costales  
 Ecarteurs des côtes  
 Divaricatori costali



Castañeda  
 für Säuglinge  
 for babies  
 para recién nacidos  
 pour nourissons  
 per neonati

Seitenvalven lateral blades hojas laterales valves latérales valve laterali	10.5 x 32 mm	Spreizweite spreading abertura ouverture apertura	65 mm
---	--------------	---	-------



Castañeda  
 für Kleinkinder  
 for infants  
 para bebés  
 pour petits enfants  
 per bambini piccoli

Seitenvalven lateral blades hojas laterales valves latérales valve laterali	12 x 45 mm	Spreizweite spreading abertura ouverture apertura	70 mm
---	------------	---	-------



Castañeda  
 für Kleinkinder  
 for infants  
 para bebés  
 pour petits enfants  
 per bambini piccoli

Seitenvalven lateral blades hojas laterales valves latérales valve laterali	15 x 60 mm	Spreizweite spreading abertura ouverture apertura	120 mm
---	------------	---	--------

Herz- u. Gefäßchirurgie . cardiovascular Surgery . Cirugia cardiovascular  
 Rippensperrer  
 Rib Retractors  
 Separadores costales  
 Ecarteurs des côtes  
 Divaricatori costali



Finochietto (modif.)

Seitenvalven lateral blades hojas laterales valves latérales valve laterali	14 x 15 mm	Spreizweite spreading abertura ouverture apertura	120 mm
---	------------	---	--------



Haight

Seitenvalven lateral blades hojas laterales valves latérales valve laterali	30 x 30 mm	Spreizweite spreading abertura ouverture apertura	120 mm
---	------------	---	--------



Herz- u. Gefäßchirurgie . Chirurgie cardio-vasculaire . Chirurgia cardiovascolare  
**Sternumspreizer**  
**Sternal Retractors**  
**Separadores esternales**  
**Ecarteurs à sternum**  
**Divaricatori per sterno**



**Morse-Favaloro**  
 für Kinder  
 for children  
 para niños  
 pour enfants  
 per bambini

MAB15-026

4 bewegliche Valven 4 movable blades 4 valvas móviles 4 valves mobiles 4 valve mobili	Spreizweite spreading abertura ouverture apertura
17 x 22 mm	160 mm



**Morse**  
 für Erwachsene  
 for adults  
 para adultos  
 pour adultes  
 per adulti

MAB15-027

4 bewegliche Valven 4 movable blades 4 valvas móviles 4 valves mobiles 4 valve mobili	Spreizweite spreading abertura ouverture apertura
22 x 27 mm	200 mm



Herz- u. Gefäßchirurgie . cardiovascular Surgery . Cirugía cardiovascular  
**Rippensperrer**  
**Rib Retractors**  
**Separadores costales**  
**Ecarteurs des côtes**  
**Divaricatori costali**



**Tuffier**

MAB15-028

Seitenvalven lateral blades hojas laterales valves latérales valve laterali	Spreizweite spreading abertura ouverture apertura
45 x 45 mm	160 mm



**Finochietto, Baby**

MAB15-029

Seitenvalven lateral blades hojas laterales valves latérales valve laterali	Spreizweite spreading abertura ouverture apertura
14 x 15 mm	75 mm



**Finochietto**

MAB15-030  
 MAB15-031  
 MAB15-032

Seitenvalven lateral blades hojas laterales valves latérales valve laterali	Spreizweite spreading abertura ouverture apertura
30 x 45 mm	150 mm
46 x 62 mm	190 mm
80 x 65 mm	190 mm

Herz- u. Gefäßchirurgie . Cardiovascular Surgery . Cirugía cardiovascular  
**Rippensperrer**  
**Rib Retractors**  
**Separadores costales**  
**Ecarteurs des côtes**  
**Divaricatori costali**



**DeBakey**

MAB15-033

mit 3 Paar Valven with 3 pairs of blades con 3 pares de valvas avec 3 paires de valves con 3 paia di valve	Spreizweite spreading abertura ouverture apertura
	150 mm



**Sperrer allein**  
 Retractor only  
 Separador suelto  
 Ecarteur seul  
 Divaricatore solo

MAB15-034

MAB15-035 = Fig.1	30 x 30 mm
MAB15-036 = Fig.2	40 x 40 mm
MAB15-037 = Fig.3	50 x 50 mm

Herz- u. Gefäßchirurgie . Chirurgie cardio-vasculaire . Chirurgia cardiovascolare  
**Rippensperrer**  
**Rib Retractors**  
**Separadores costales**  
**Ecarteurs des côtes**  
**Divaricatori costali**



**DeBakey**

MAB15-038

mit 3 Paar Valven with 3 pairs of blades con 3 pares de valvas avec 3 paires de valves con 3 paia di valve	Spreizweite spreading abertura ouverture apertura
	200 mm



**Sperrer allein**  
 Retractor only  
 Separador suelto  
 Ecarteur seul  
 Divaricatore solo

MAB15-039

MAB15-040 = Fig.1	60 x 60 mm
MAB15-041 = Fig.2	50 x 80 mm
MAB15-042 = Fig.3	40 x 100 mm
MAB15-043 = Fig.4	80 x 60 mm
MAB15-044 = Fig.5	50 x 66 mm



Herz- u. Gefäßchirurgie . Cardiovascular Surgery . Cirugía cardiovascular  
 Thoraxsperrer  
 Thoracic Retractor  
 Separador torácico  
 Ecarteur thoracique  
 Divaricatore per il torace

Herz- u. Gefäßchirurgie . Chirurgie cardio-vasculaire . Chirurgia cardiovascolare  
 I.M.A.-Thoraxsperrer  
 Thoracic and I.M.A. Retractor  
 Separador Torácico e I.M.A.  
 Ecarteur thoracique et I.M.A.  
 Divaricatore per il torace ed I.M.A.



(Mercedes-Sperrer)  
 (Mercedes Retractor)  
 (Retractor Mercedes)  
 (Ecarteur Mercedes)  
 (Divaricatore Mercedes)  
 MAB15-045

mit je 1 Paar Valven  
 with 1 pair of blades each  
 con 1 par de valvas de c.u.  
 avec chacun 1 paire de valves  
 con un paio di valve ognuno

Sperrer allein  
 Retractor only  
 Separador suelto  
 Valve latérales  
 Divaricatore solo  
 MAB15-046



MAB15-049 24-191 65 + 24-191-75

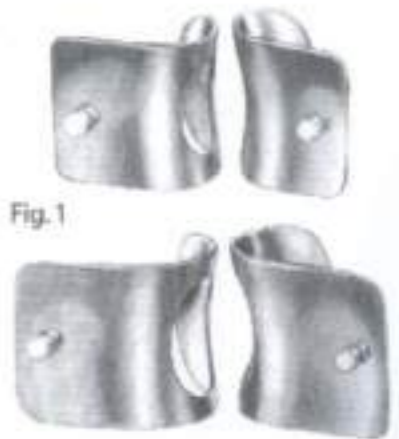

Fig.1  
 Fig.2

Seitenvalven  
 Lateral Blades  
 Valvas laterales -  
 Valves latérales  
 Valve laterali

Paar  
 pair  
 par  
 paire  
 Paio

MAB15-047 = Fig.1 48 x 68 mm  
 MAB15-048 = Fig.2 70 x 75 mm



Stielvalve für I.M.A. Sperrer  
 Lateral Blade for I.M.A. Retractor  
 Valva para separador I.M.A.  
 Valve pour écarteur I.M.A.  
 Valve per divaricatore I.M.A.

links left  
 izquierda  
 gauche  
 sinistra

rechts right  
 derecha  
 droite  
 destra

MAB15-050 40 x 50 x 80 mm  
 MAB15-051 40 x 50 x 80 mm

Herz- u. Gefäßchirurgie . Chirurgie cardio-vasculaire . Chirurgia cardiovascolare  
 Rippenkontraktoren  
 Rib Contractos  
 Aproximadores para costillas  
 Rapprocheurs des côtes  
 Approssimatori costali

Herz- u. Gefäßchirurgie . Chirurgie cardio-vasculaire . Chirurgia cardiovascolare  
 Bronchusklemmen  
 Bronchus Clamps  
 Pinzas bronquiales  
 Pince-clamps à bronches  
 Pinze per bronchi



Herz- u. Gefäßchirurgie . Cardiovascular Surgery . Cirugía cardiovascular  
 Lungenspatel  
 Lung Spatulas  
 Espátulas pulmonares  
 Spatules pulmonaires  
 Spatole per pulmone

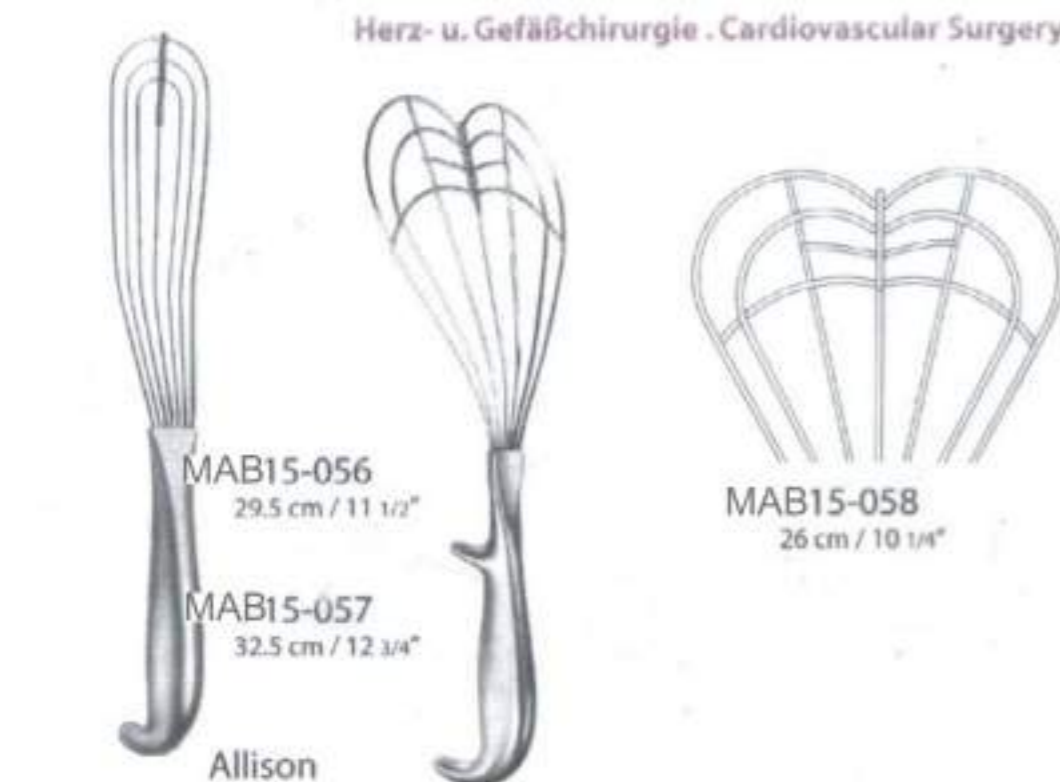



Herz- u. Gefäßchirurgie . Cardiovascular Surgery . Cirugía cardiovascular  
 Lungenfasszangen  
 Lung Grasping Forceps  
 Pinzas para coger el pulmón  
 Pince-clamps au poumon  
 Pinze per afferrare polmone

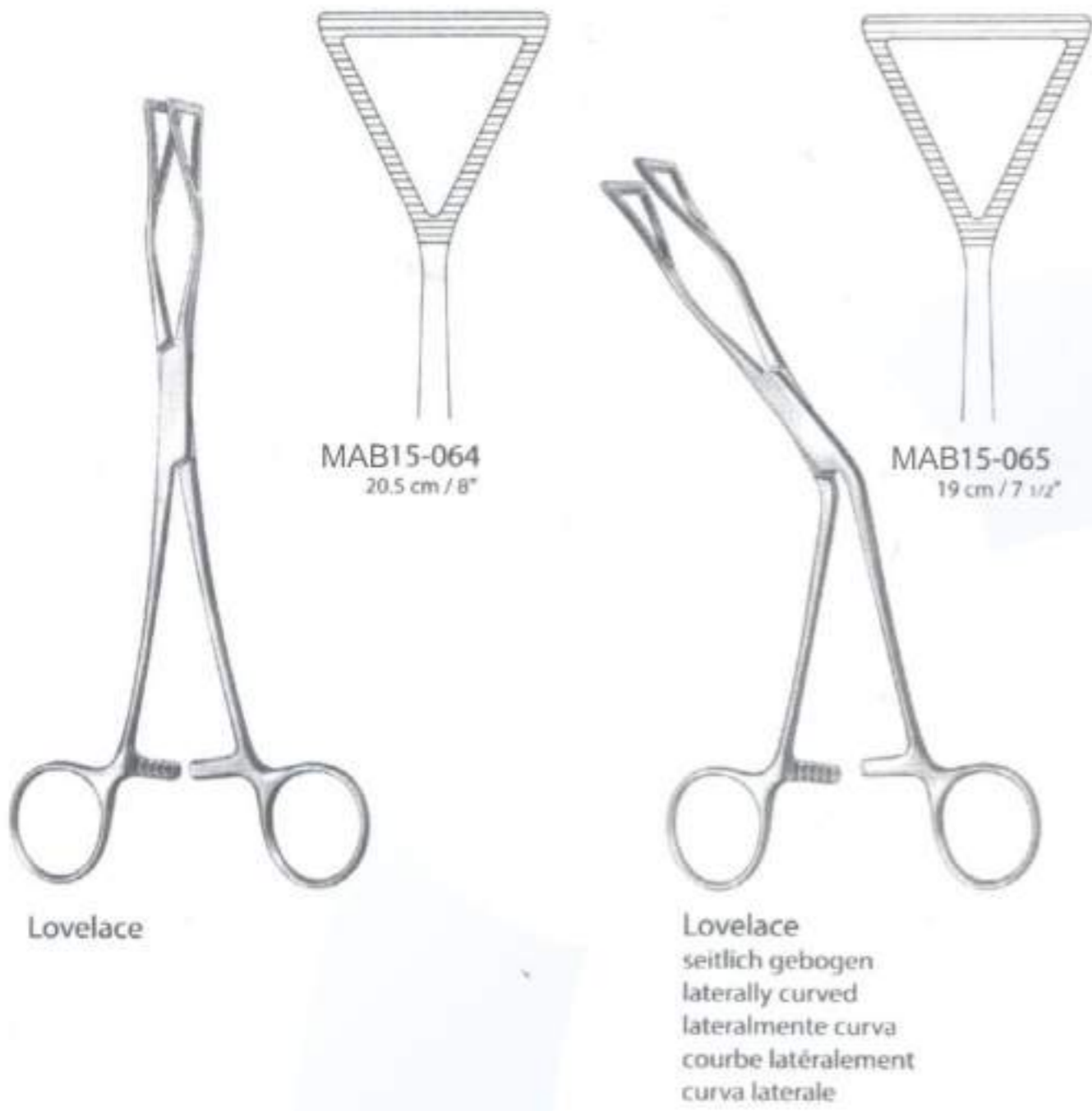

Herz- u. Gefäßchirurgie . Chirurgie cardio-vasculaire . Chirurgia cardiovascolare  
 Bulldogklemmen  
 Bulldog Clamps  
 Clamps Bulldog  
 Clamps Bulldog  
 Clamps Bulldog



Herz- u. Gefäßchirurgie . Cardiovascular Surgery . Cirugía cardiovascular  
 Bulldogklemmen  
 Bulldog Clamps  
 Clamps Bulldog  
 Clamps Bulldog  
 Clamps Bulldog



Herz- u. Gefäßchirurgie . Chirurgie cardio-vasculaire . Chirurgia cardiovascolare  
 Arterienklemmen  
 Haemostatic Forceps  
 Pinzas hemostáticas  
 Pincas hemostatiques  
 Pinze emostatiche

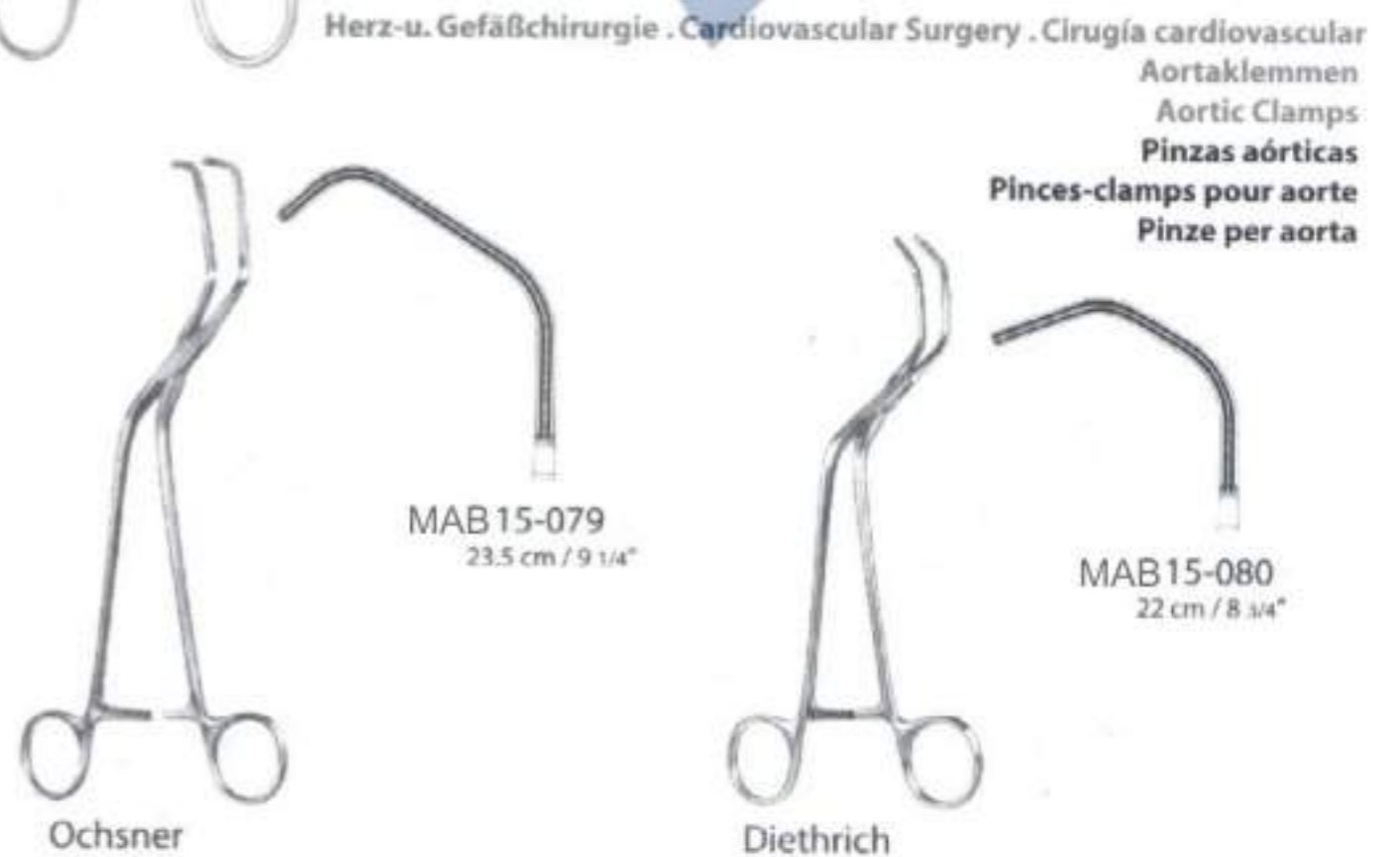



Herz- u. Gefäßchirurgie . Chirurgie cardio-vasculaire . Chirurgia cardiovascolare  
**Mehrzweck-Gefäßklemmen**  
 Multi purpose Vascular Clamps  
 Pinzas vasculares de usos múltiples  
 Pincas vasculaires universelles  
 Pinze vascolari universali

Herz- u. Gefäßchirurgie . Cardiovascular Surgery . Cirugia cardiovascular  
**Peripheral-Gefäßklemmen**  
 Peripheral Vascular Clamps  
 Pinzas para vasos periféricos  
 Pincas-clamps vasculaires périphériques  
 Pinze vascolari periferali



Dardik

Gregory

Shunt bypass

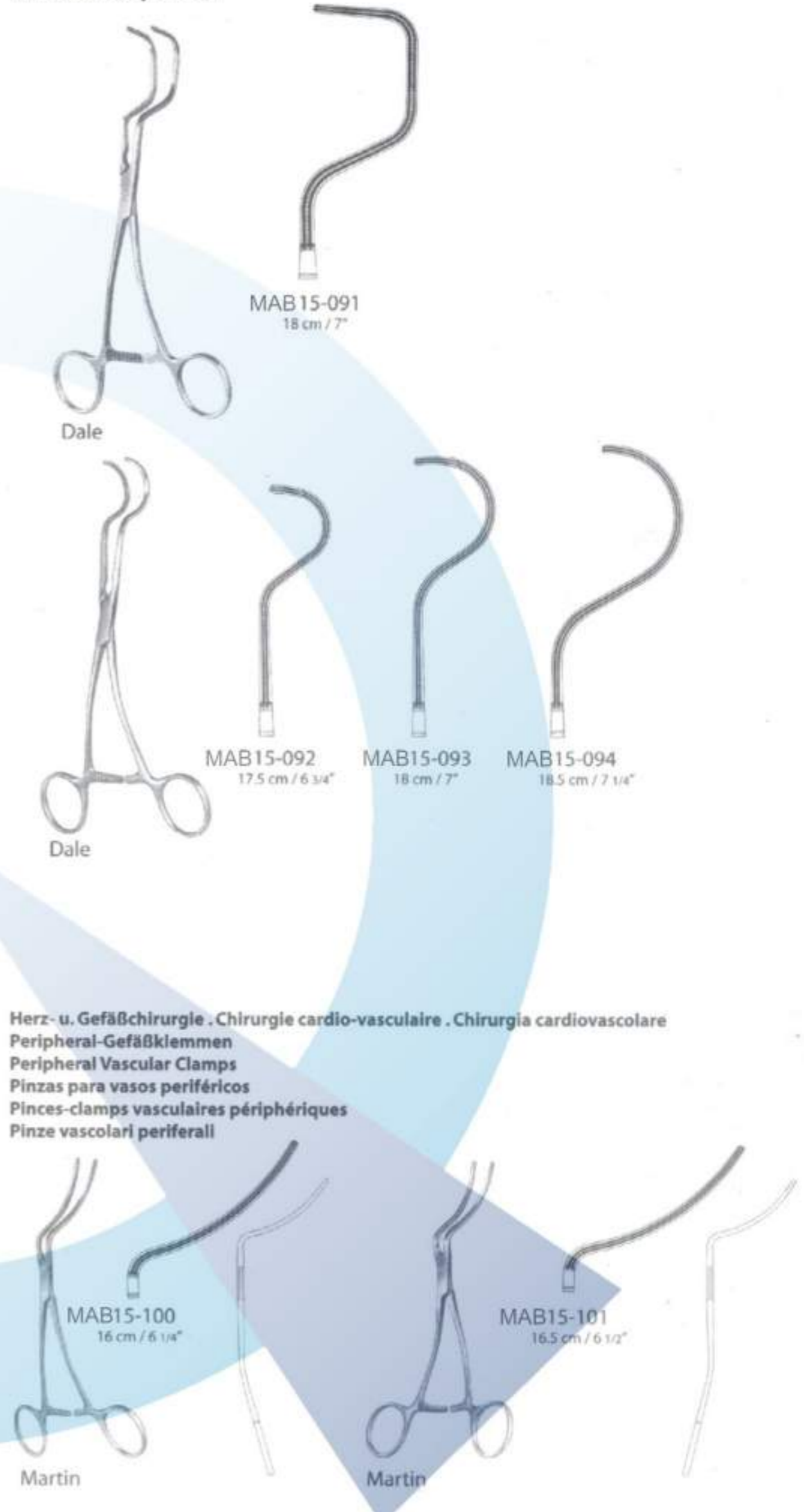

Dale

Dale

Martin

Martin

Herz- u. Gefäßchirurgie . Chirurgie cardio-vasculaire . Chirurgia cardiovascolare  
**Profundaklemmen**  
 Profunda Clamps  
 Pinzas para la profunda  
 Pincas fémorale  
 Pinze profunda

Herz- u. Gefäßchirurgie . Chirurgie cardio-vasculaire . Chirurgia cardiovascolare  
**Peripheral-Gefäßklemmen**  
 Peripheral Vascular Clamps  
 Pinzas para vasos periféricos  
 Pincas-clamps vasculaires périphériques  
 Pinze vascolari periferali

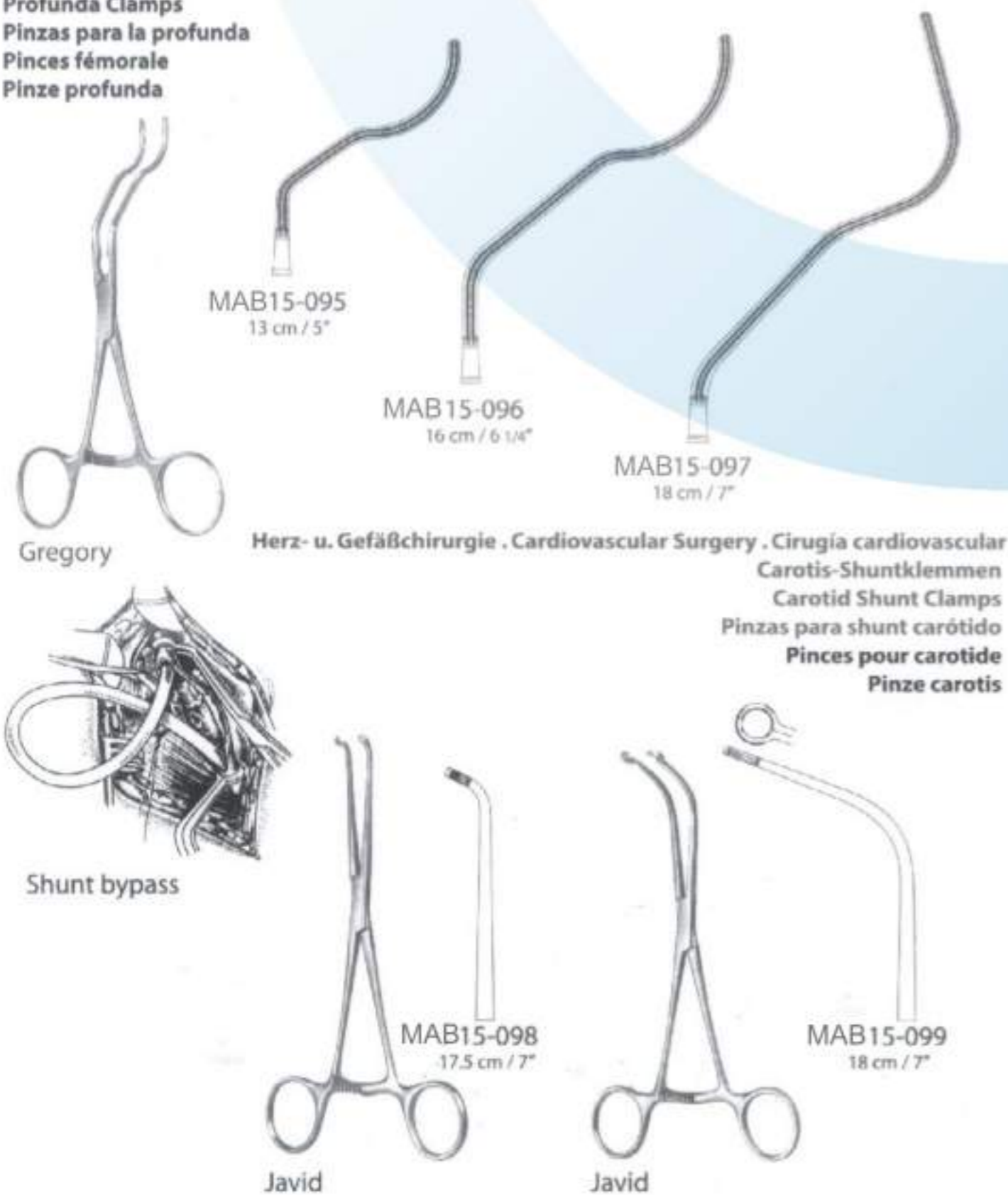

Herz- u. Gefäßchirurgie . Cardiovascular Surgery . Cirugia cardiovascular  
**Carotis-Shuntklemmen**  
 Carotid Shunt Clamps  
 Pinzas para shunt carótido  
 Pincas pour carotide  
 Pinze carotis

Javid

Javid

Martin

Martin



Herz- u. Gefäßchirurgie . Cardiovascular Surgery . Cirugia cardiovascular  
 Peripheral-Gefäßklemmen  
 Peripheral Vascular Clamps  
 Pinzas para vasos periféricos  
 Pinces-clamps vasculaires périphériques  
 Pinze vascolari periferali

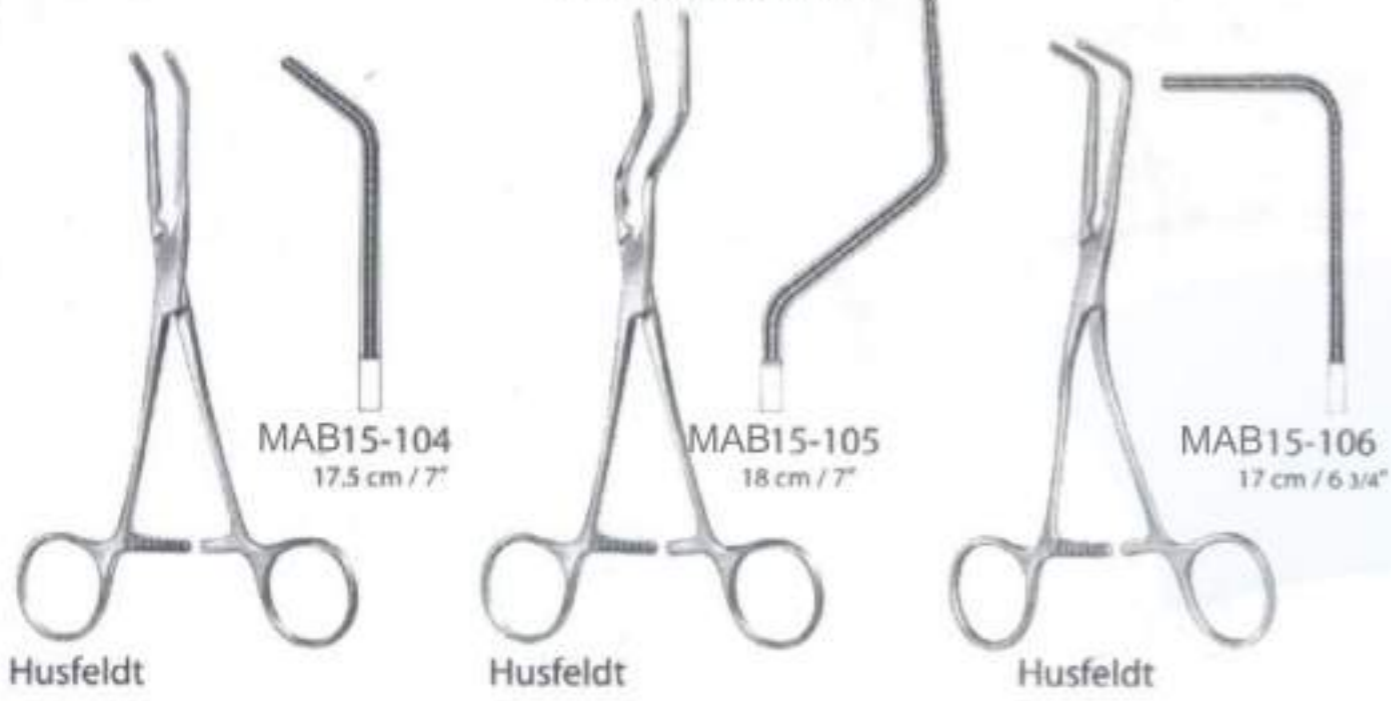
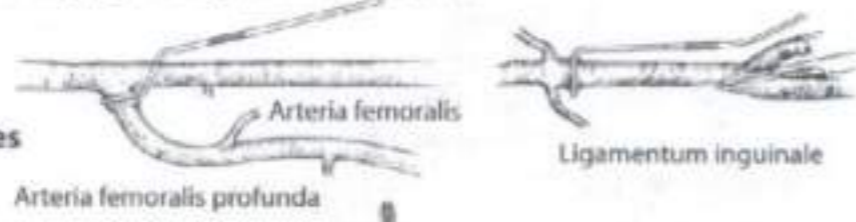

Herz- u. Gefäßchirurgie . Cardiovascular Surgery . Cirugia cardiovascular  
 Katheterklemmen  
 Catheter Clamps  
 Pinzas para catéteres  
 Pinces pour sondes  
 Pinze per cateteri



Herz- u. Gefäßchirurgie . Chirurgie cardio-vasculaire . Chirurgia cardiovascolare  
 Gefäßpinzetten  
 Vascular Forceps  
 Pinzas de disección vascular  
 Pinces à dissection vasculaires  
 Pinze per dissezione vascolari



Herz- u. Gefäßchirurgie . Chirurgie cardio-vasculaire . Chirurgia cardiovascolare  
 Gefäßpinzetten  
 Vascular Forceps  
 Pinzas de disección vascular  
 Pinces à dissection vasculaires  
 Pinze per dissezione vascolari



Herz- u. Gefäßchirurgie . Cardiovascular Surgery . Cirugia cardiovascular  
 Bulldogklemmen  
 Bulldog Clamps  
 Clamps Bulldog  
 Clamps Bulldog  
 Clamps Bulldog

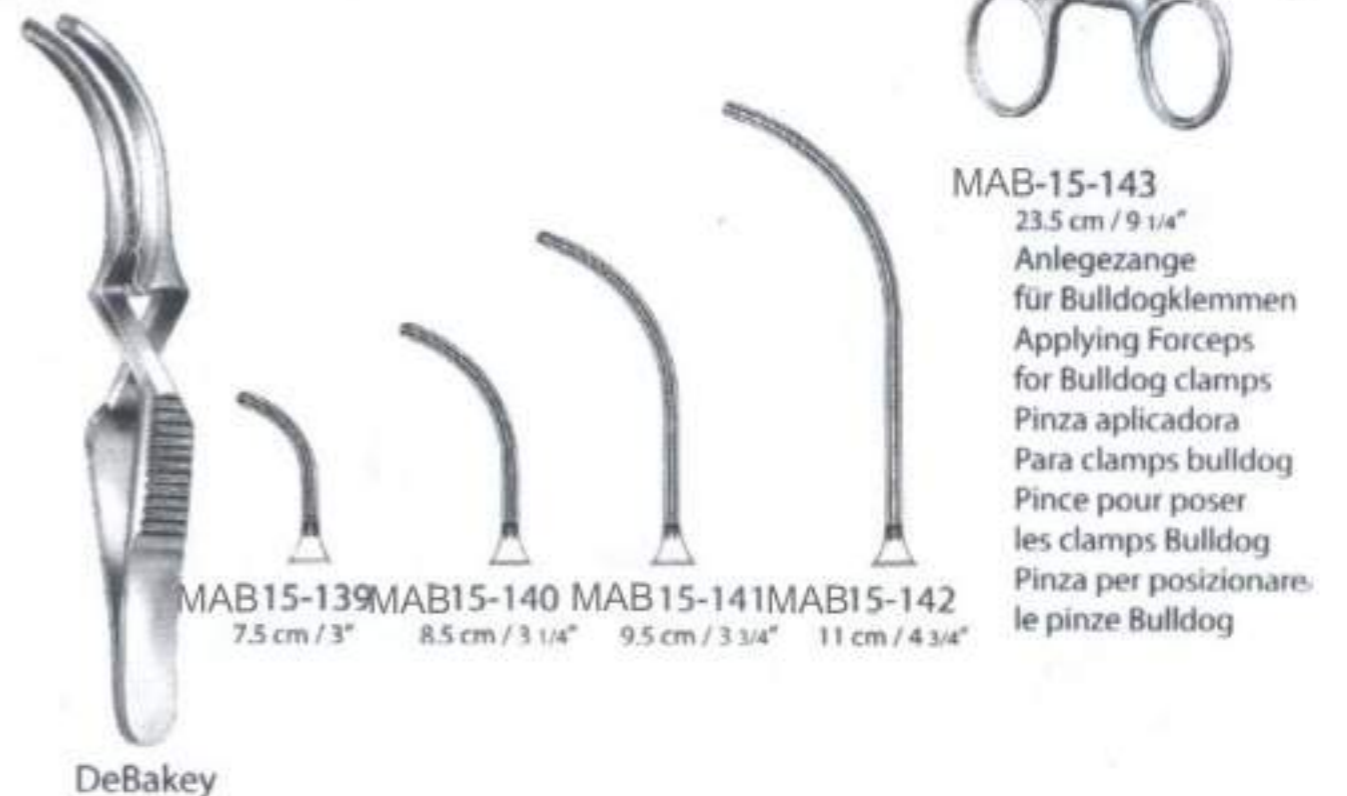
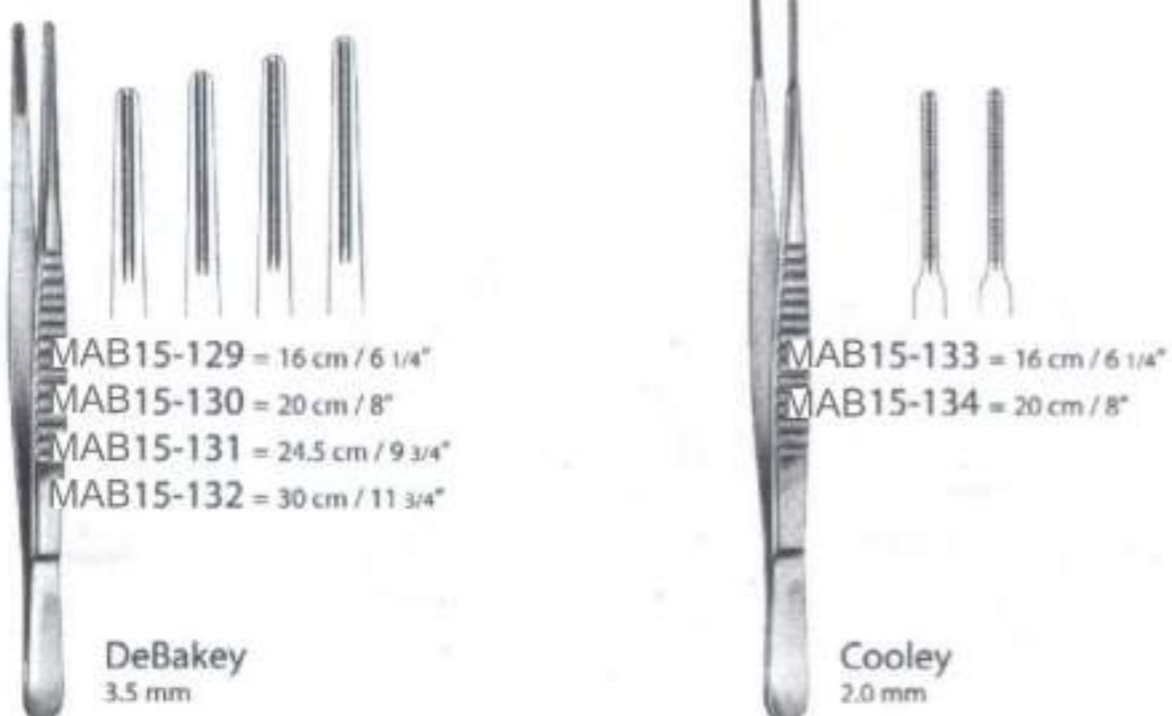



Herz- u. Gefäßchirurgie . Chirurgie cardio-vasculaire . Chirurgia cardiovascolare  
**Bulldogklemmen**  
 Bulldog Clamps  
 Clamps Bulldog  
 Clamps Bulldog  
 Clamps Bulldog

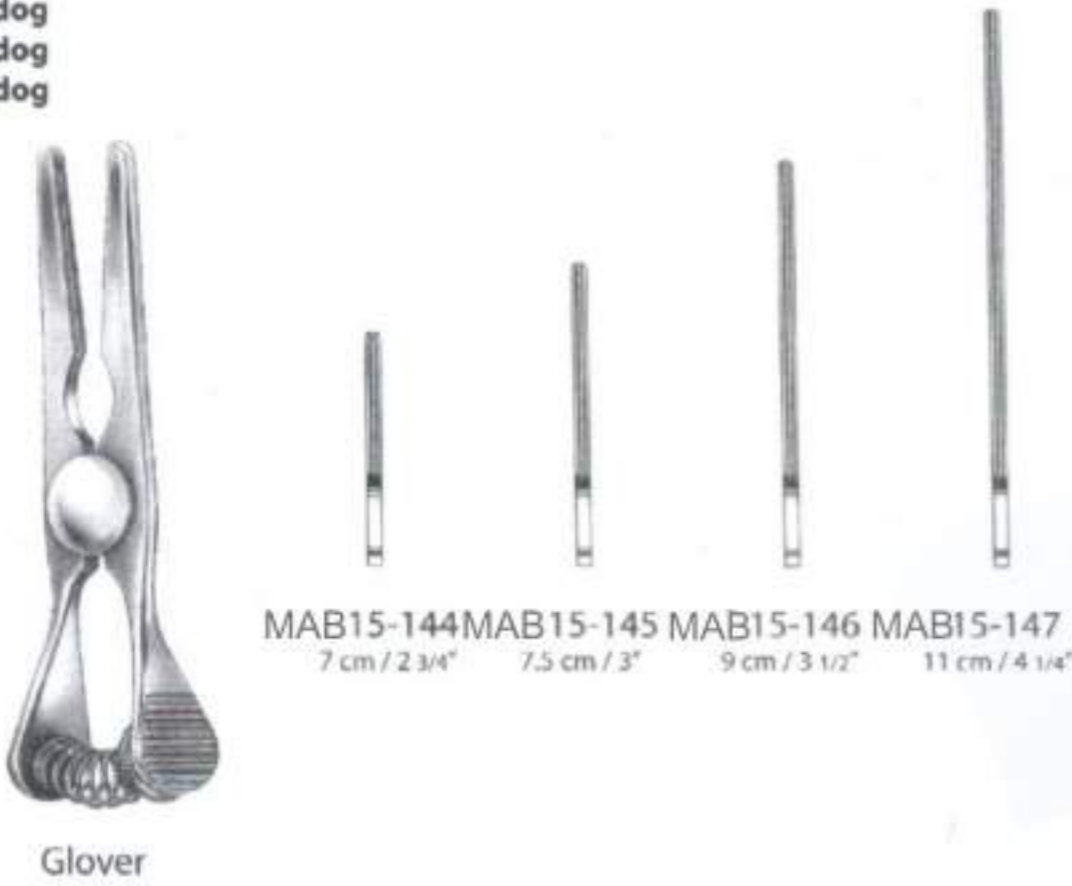

Herz- u. Gefäßchirurgie . Cardiovascular Surgery . Cirugia cardiovascular  
**Coarctationsklemmen**  
 Coarctation Clamps  
 Pinzas para Coarctación  
 Pincas-clamps pour Coarctation  
 Pinze per Coartazione

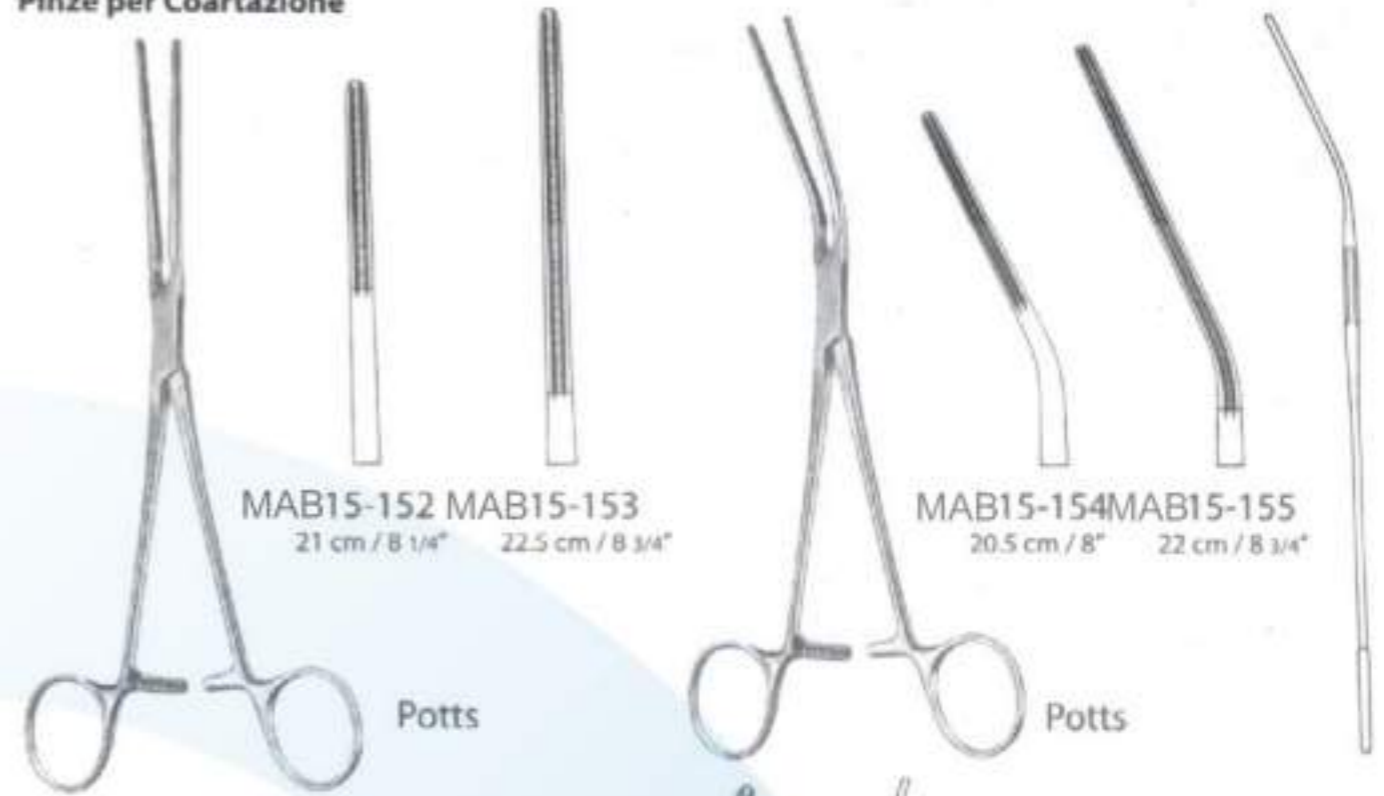

Herz- u. Gefäßchirurgie . Chirurgie cardio-vasculaire . Chirurgia cardiovascolare  
**Anastomosenklemmen, Ligaturklemmen**  
 Anastomosis Clamps, Ligature Forceps  
 Pinzas para anastomosis, Pinzas para ligaduras  
 Pincas-clamps à anastomose, Pincas à ligatures  
 Pinze per anastomosi, Pinze per legature

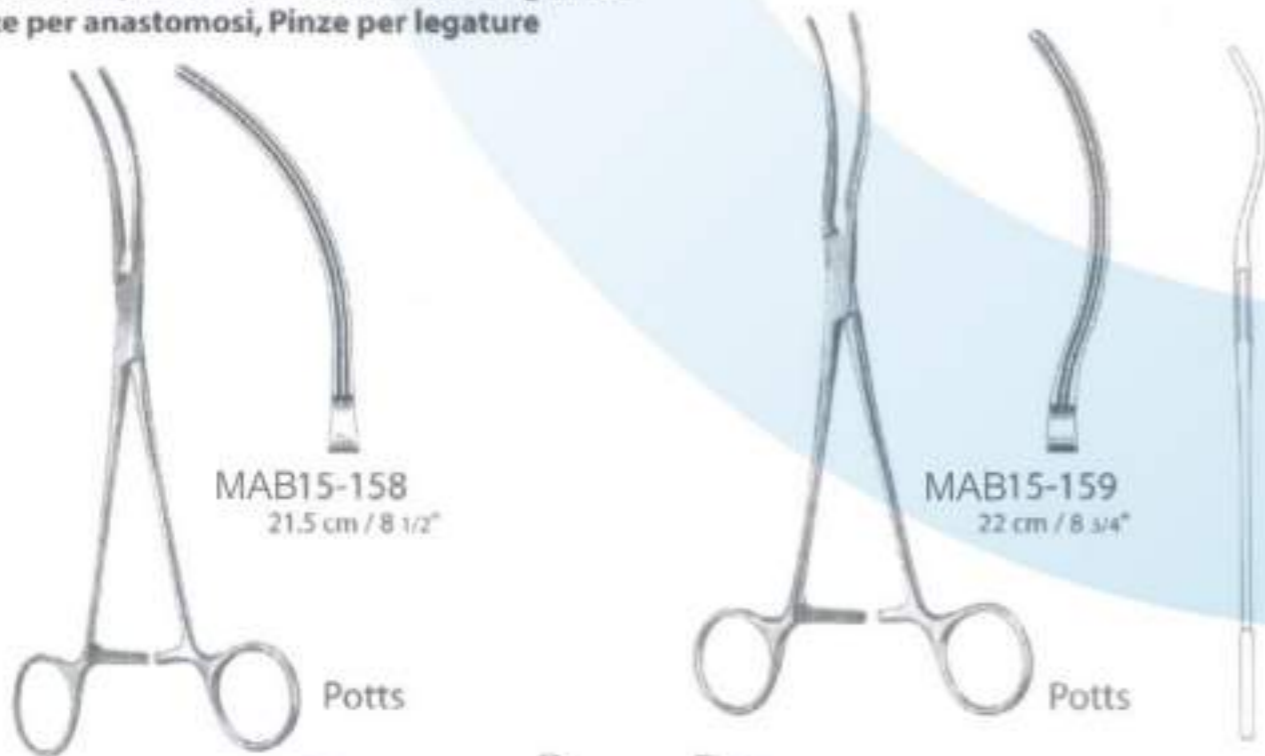

Herz- u. Gefäßchirurgie . Cardiovascular Surgery . Cirugia cardiovascular  
**Peripheral-Gefäßklemmen**  
 Peripheral Vascular Clamps  
 Pinzas para vasos periféricos  
 Pincas-clamps vasculaires périphériques  
 pinze vascolari periferali

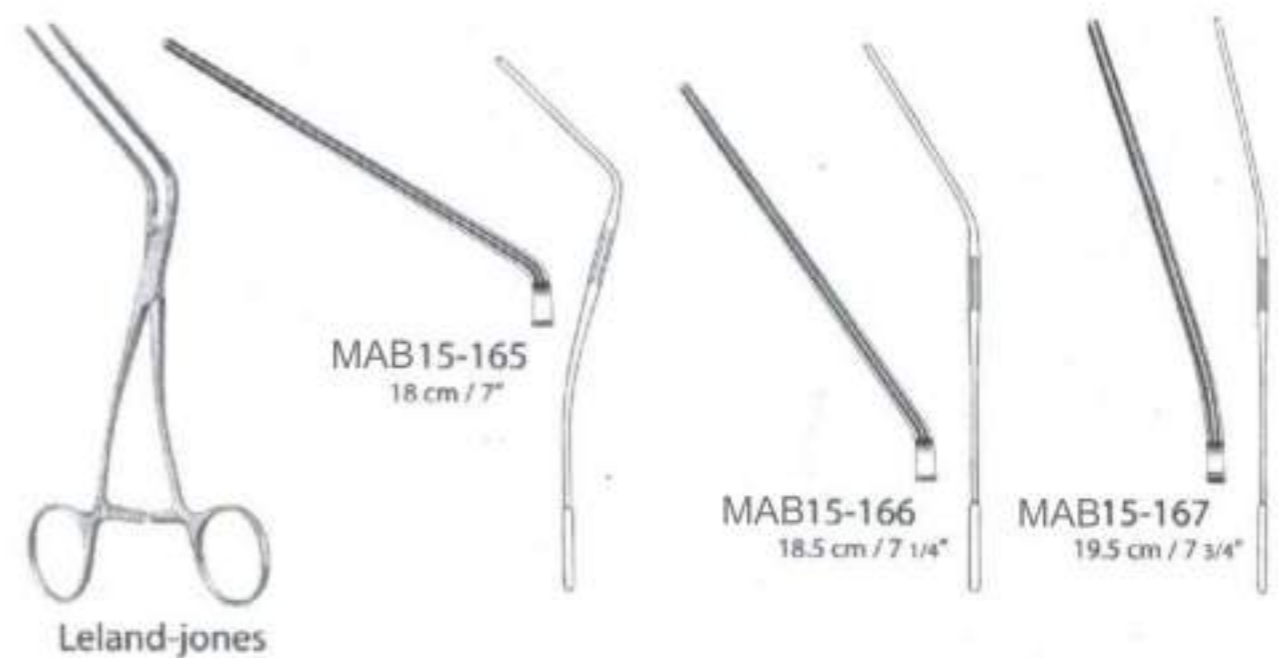
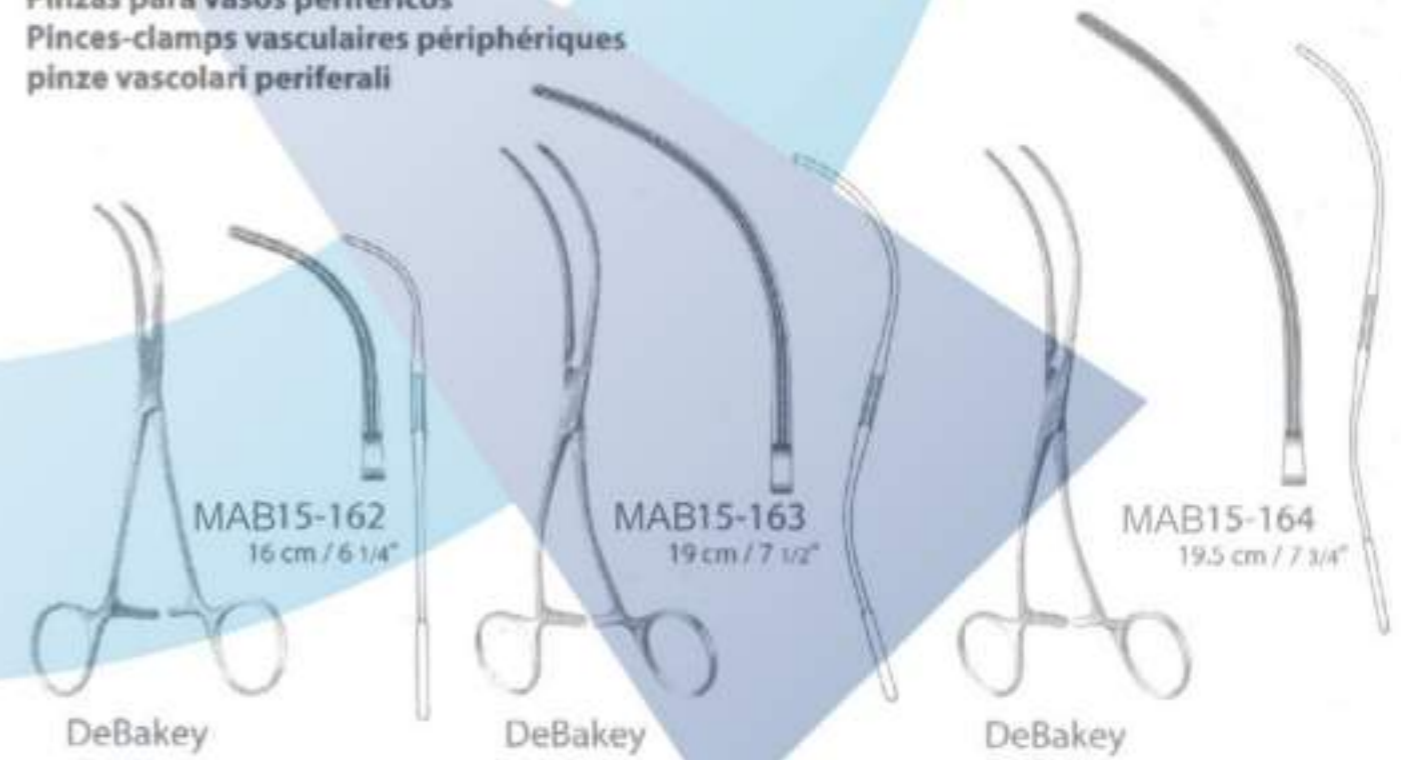



Herz- u. Gefäßchirurgie . Chirurgie cardio-vasculaire . Chirurgia cardiovascolare  
 Mehrzweck-Gefäßklemmen  
 Multi purpose Vascular Clamps  
 Pinzas vasculares de usos múltiples  
 Pinces vasculaires universelles  
 Pinze vascolari universali

Herz- u. Gefäßchirurgie . Cardiovascular Surgery . Cirugía cardiovascular  
 Aorta-Aneurysmaklemmen  
 Aortic Aneurysm Clamps  
 Pinzas para aneurisma de aórtica  
 Pince-clamps pour anévrisme de l'aorte  
 Pinze per aneurisma della aorta

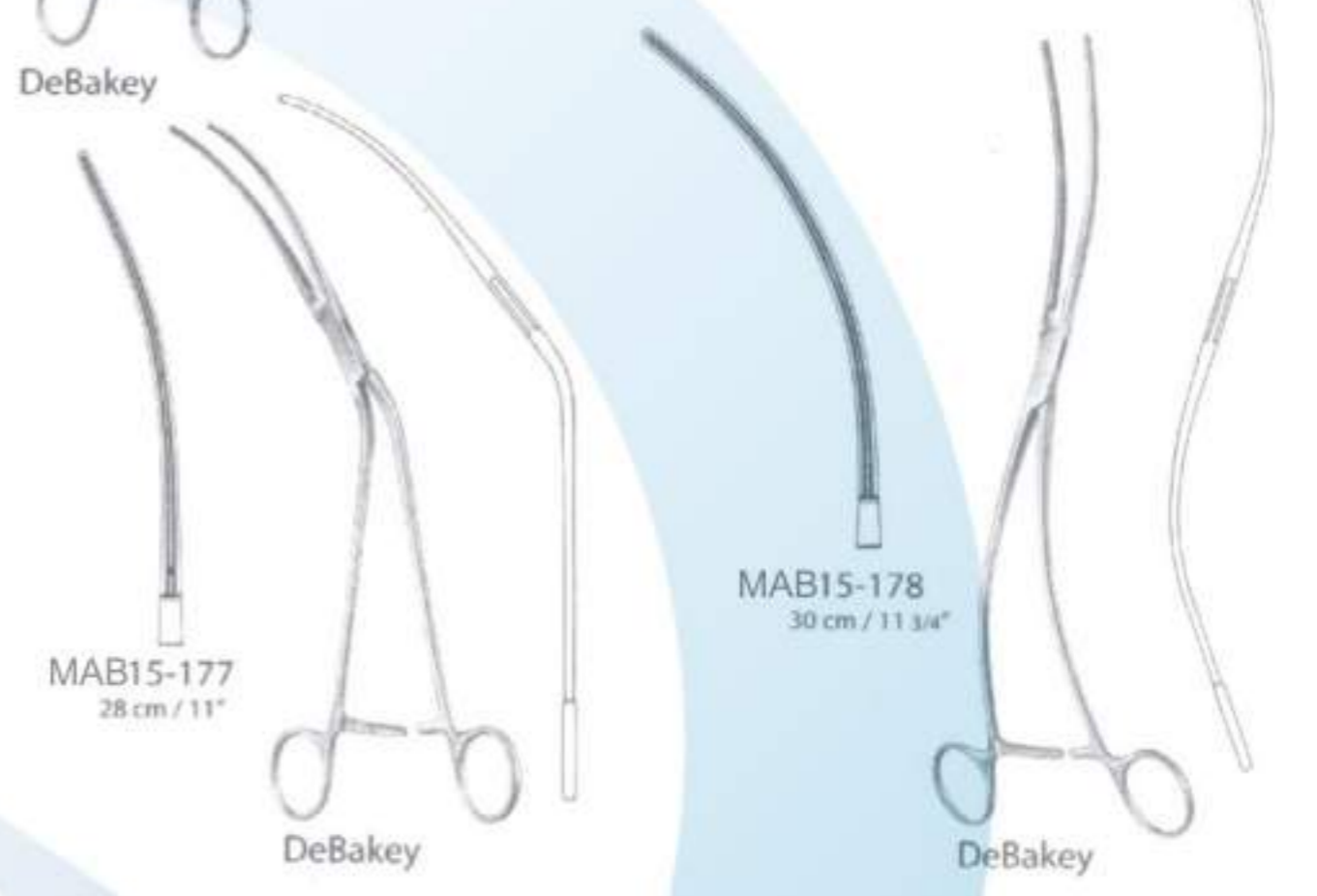
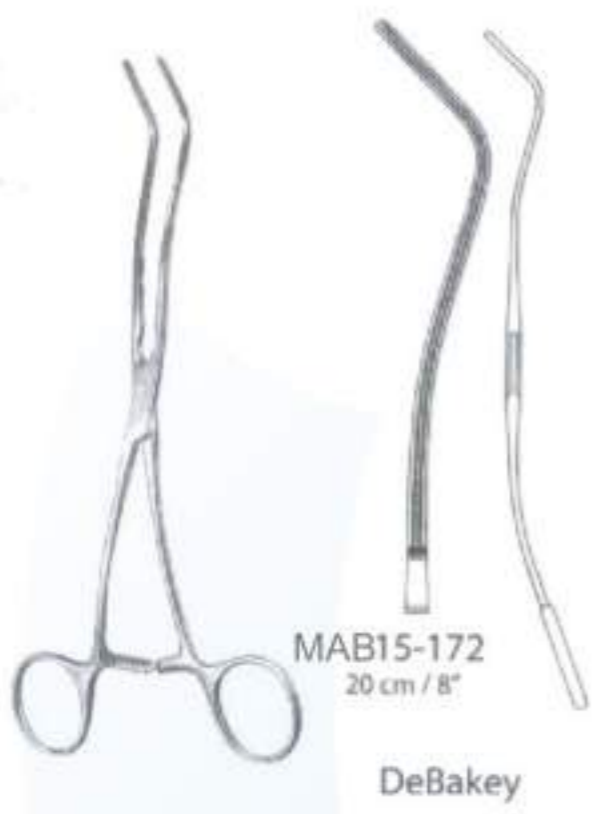
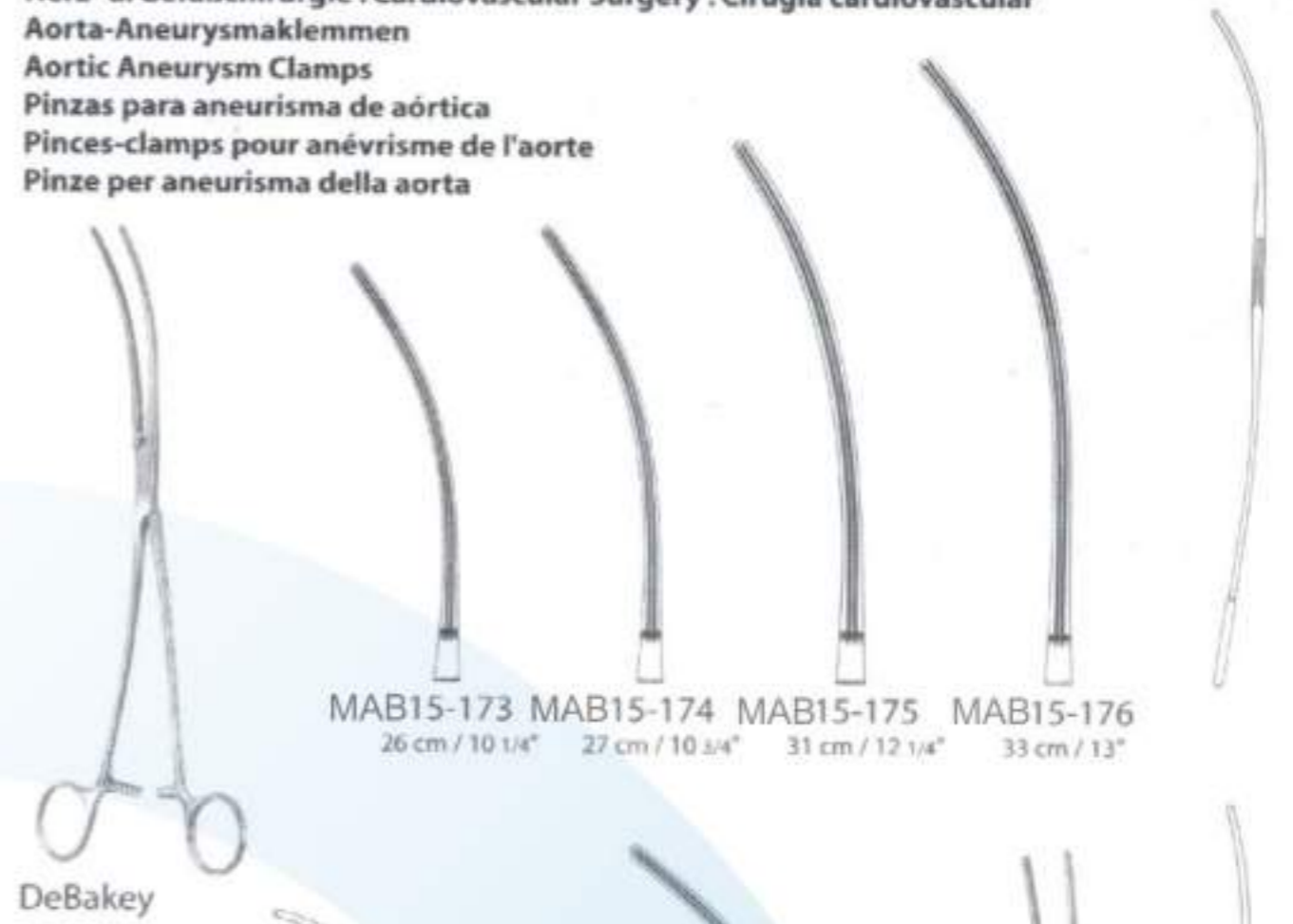
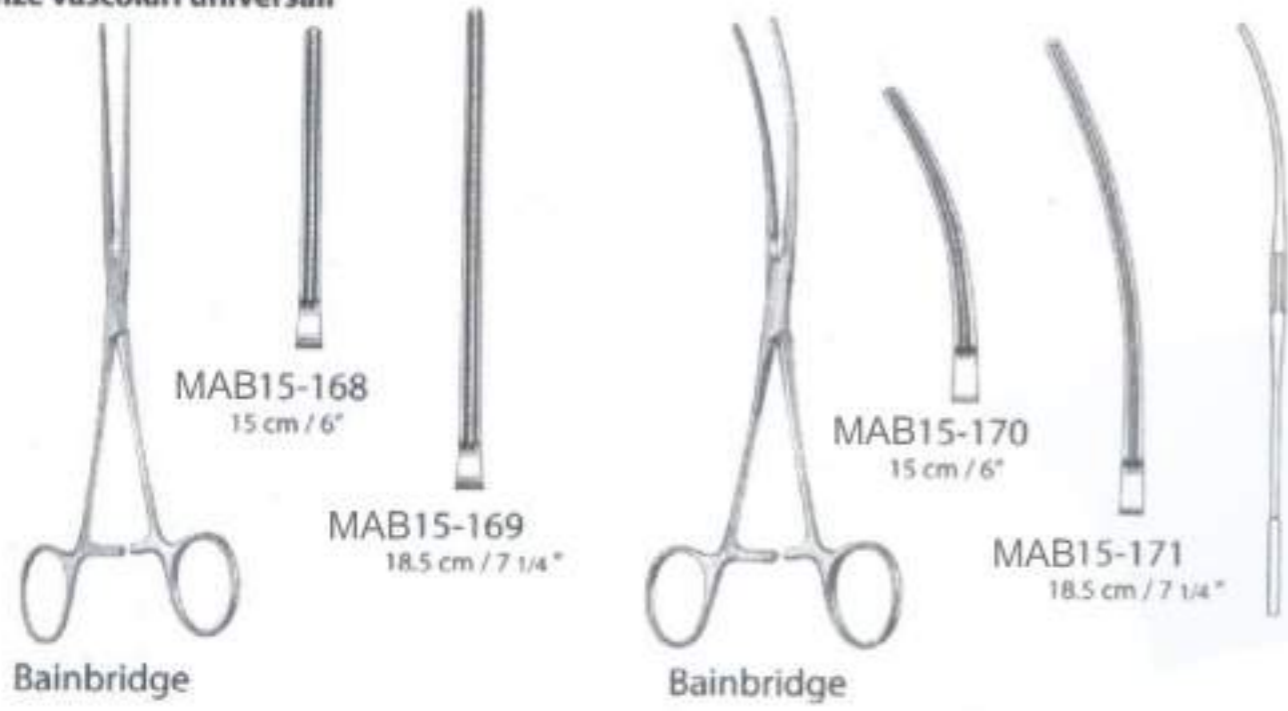

Herz- u. Gefäßchirurgie . Cardiovascular Surgery . Cirugía cardiovascular  
 Aortaklemmen, Ligaturklemmen  
 Aortic Clamps, Ligature Forceps  
 Pinzas aórticas, Pinzas para ligaduras  
 Pince-clamps pour aorte, Pince-clamps pour ligatures  
 Pinze per aorta, Pinze per legature

Herz- u. Gefäßchirurgie . Chirurgie cardio-vasculaire . Chirurgia cardiovascolare  
 Ligaturklemmen, Aortaklemmen  
 Ligature Forceps, Aortic Clamps  
 Pinzas para ligaduras, Pinzas aórticas  
 Pince-clamps pour aorte, Pince-clamps pour ligatures  
 Pinze per legature, Pinze per aorta

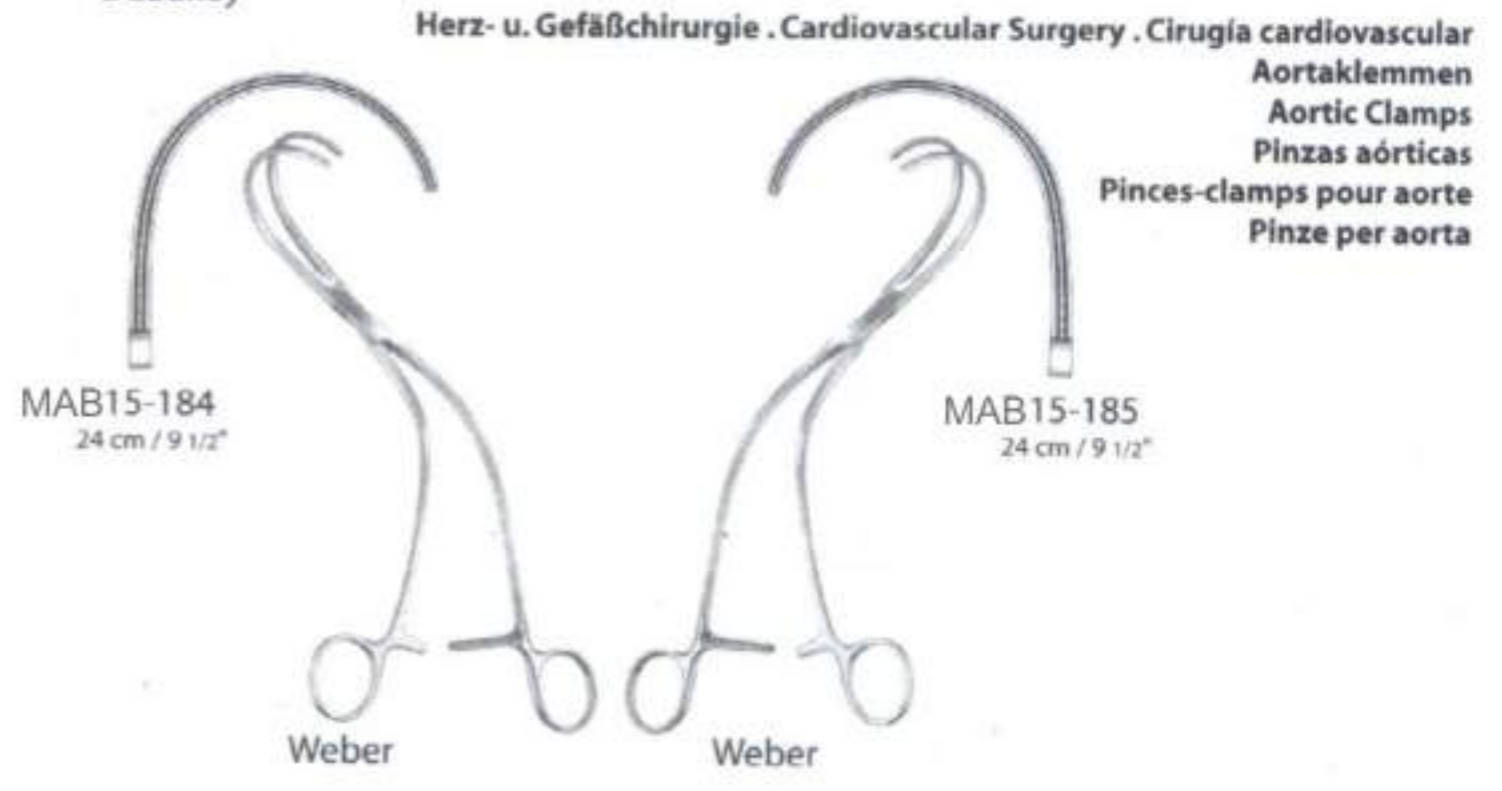
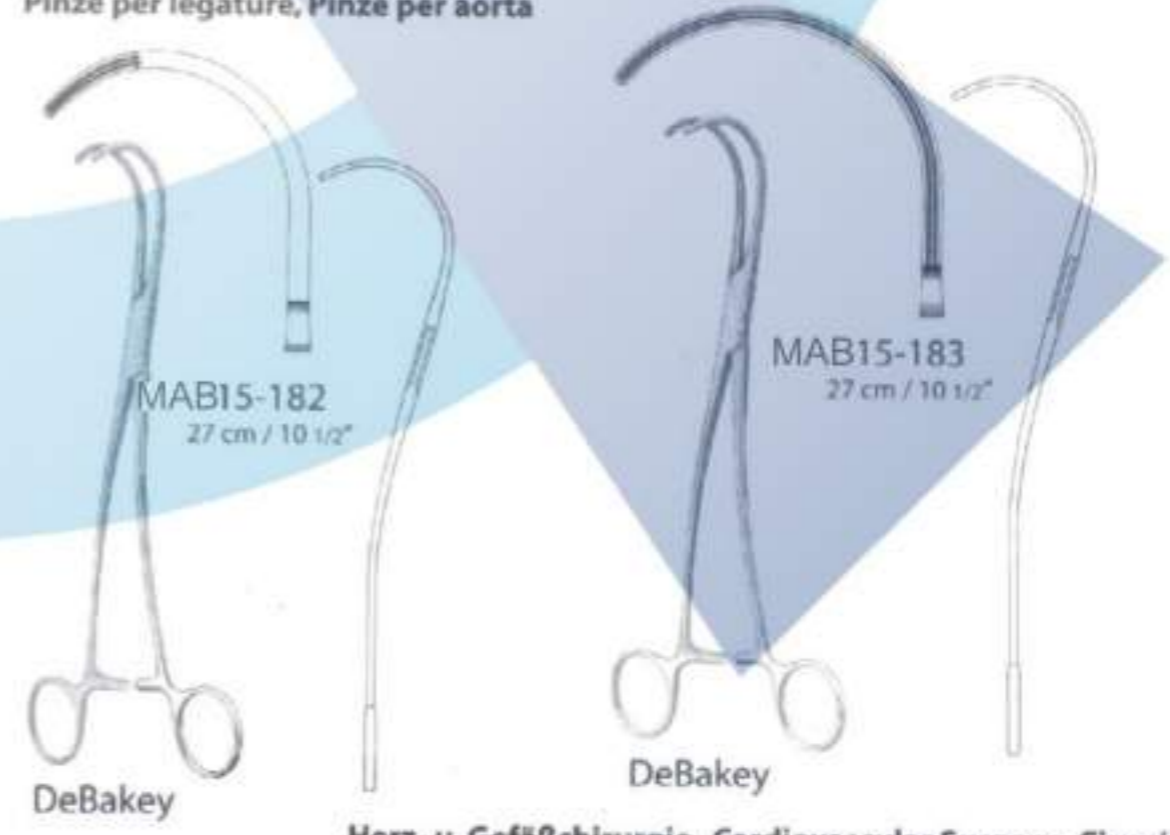



Herz- u. Gefäßchirurgie . Chirurgie cardio-vasculaire . Chirurgia cardiovascolare  
**Tangentialklammern**  
**Tangential Occlusion Clamps**  
**Pinzas para oclusión tangencial**  
**Pinces-clamps pour occlusion tangentielle**  
**Pinze per occlusione tangenziale**

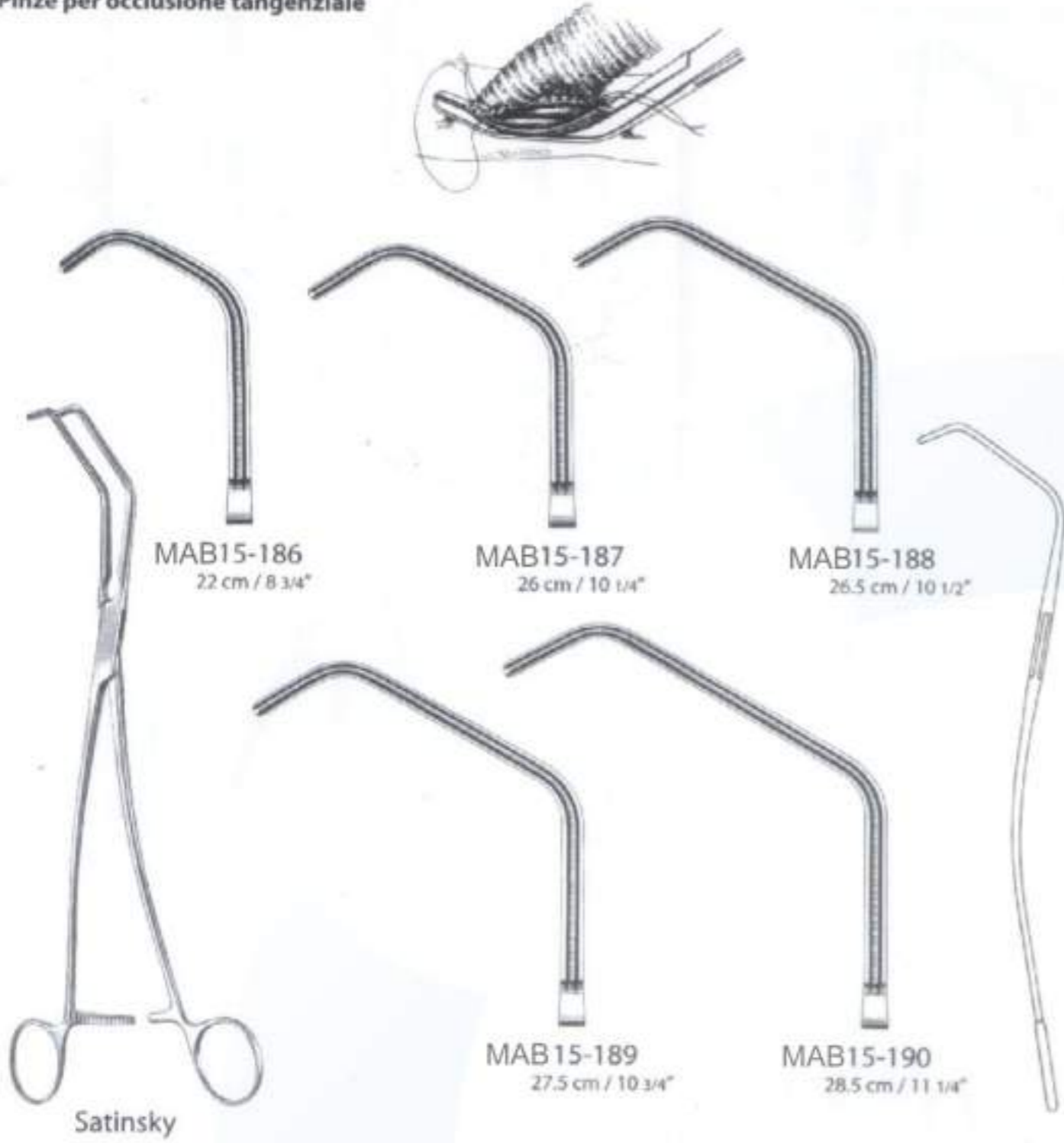

Herz- u. Gefäßchirurgie . Cardiovascular Surgery . Cirugia cardiovascular  
**Aurikelklammern**  
**Auricle Clamps**  
**Pinzas para aurícula**  
**Pinces auriculaires**  
**Pinze ventricolari**

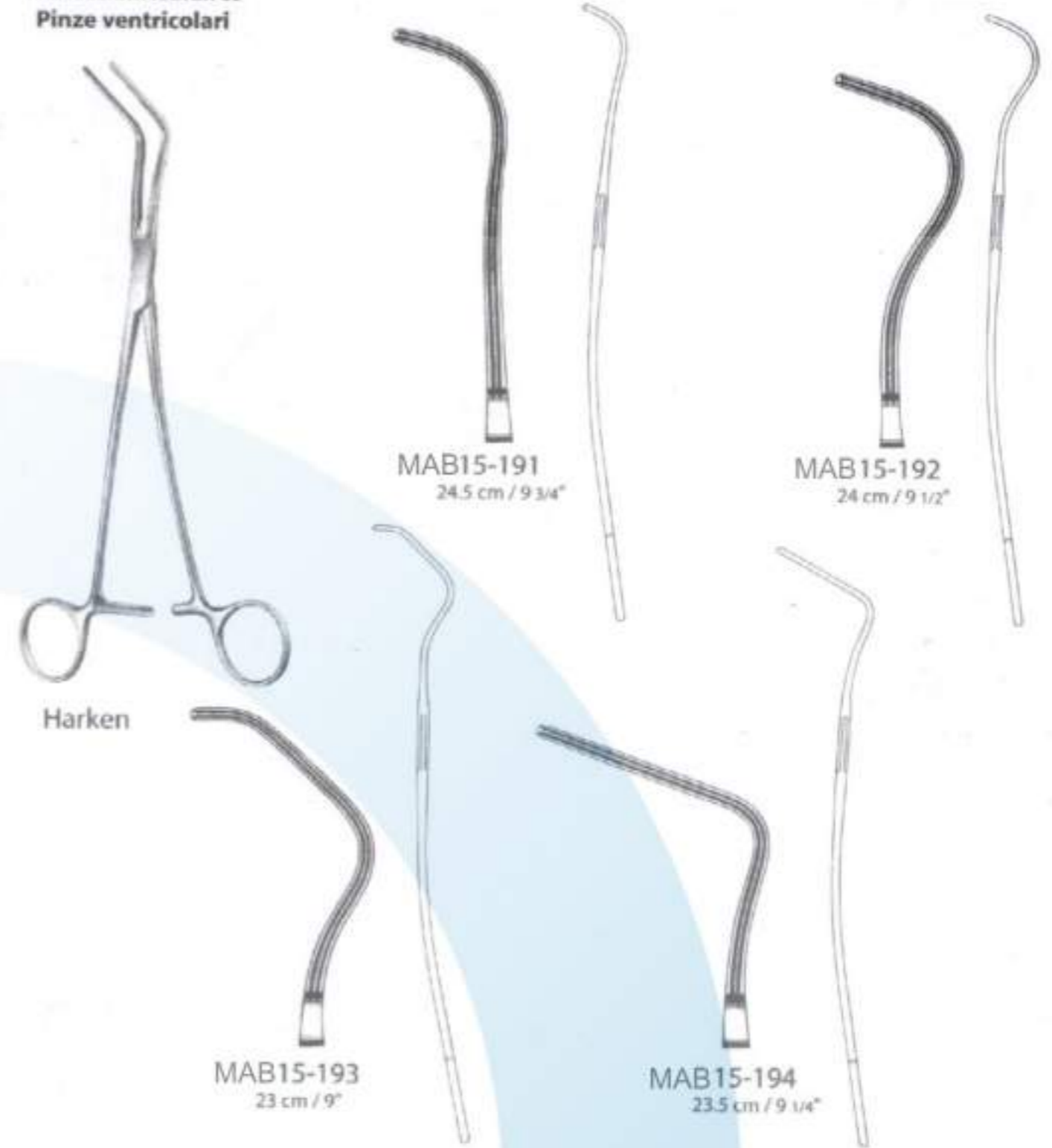

Herz- u. Gefäßchirurgie . Chirurgie cardio-vasculaire . Chirurgia cardiovascolare  
**Bronchusklammern**  
**Bronchus Clamps**  
**Pinzas bronquiales**  
**Pinces-clamps à bronches**  
**Pinze per bronchi**

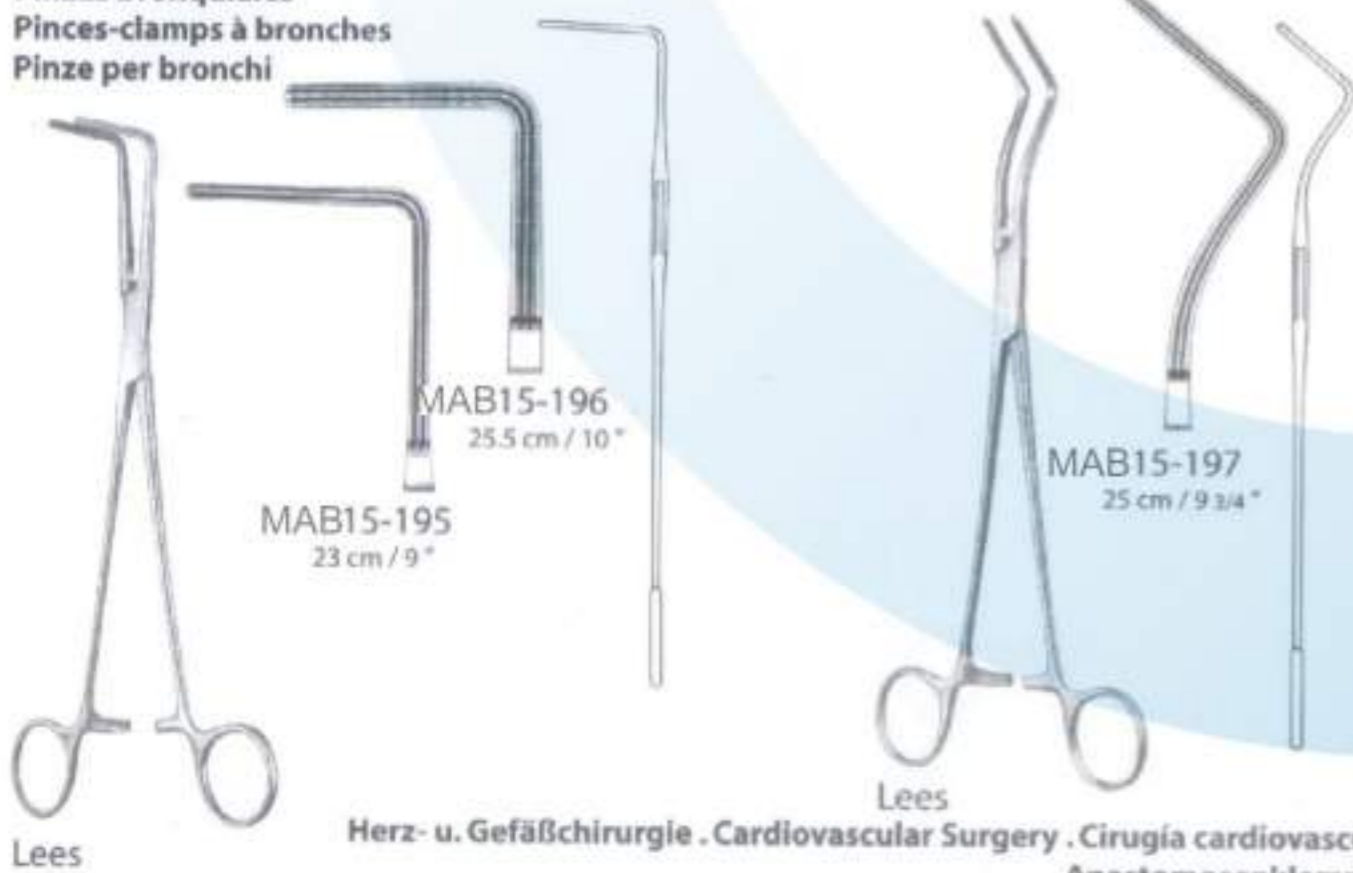

Herz- u. Gefäßchirurgie . Chirurgie cardio-vasculaire . Chirurgia cardiovascolare  
**Aortaklammern**  
**Aortic Clamps**  
**Pinzas aórticas**  
**Pinces-clamps pour aorte**  
**Pinze per aorta**

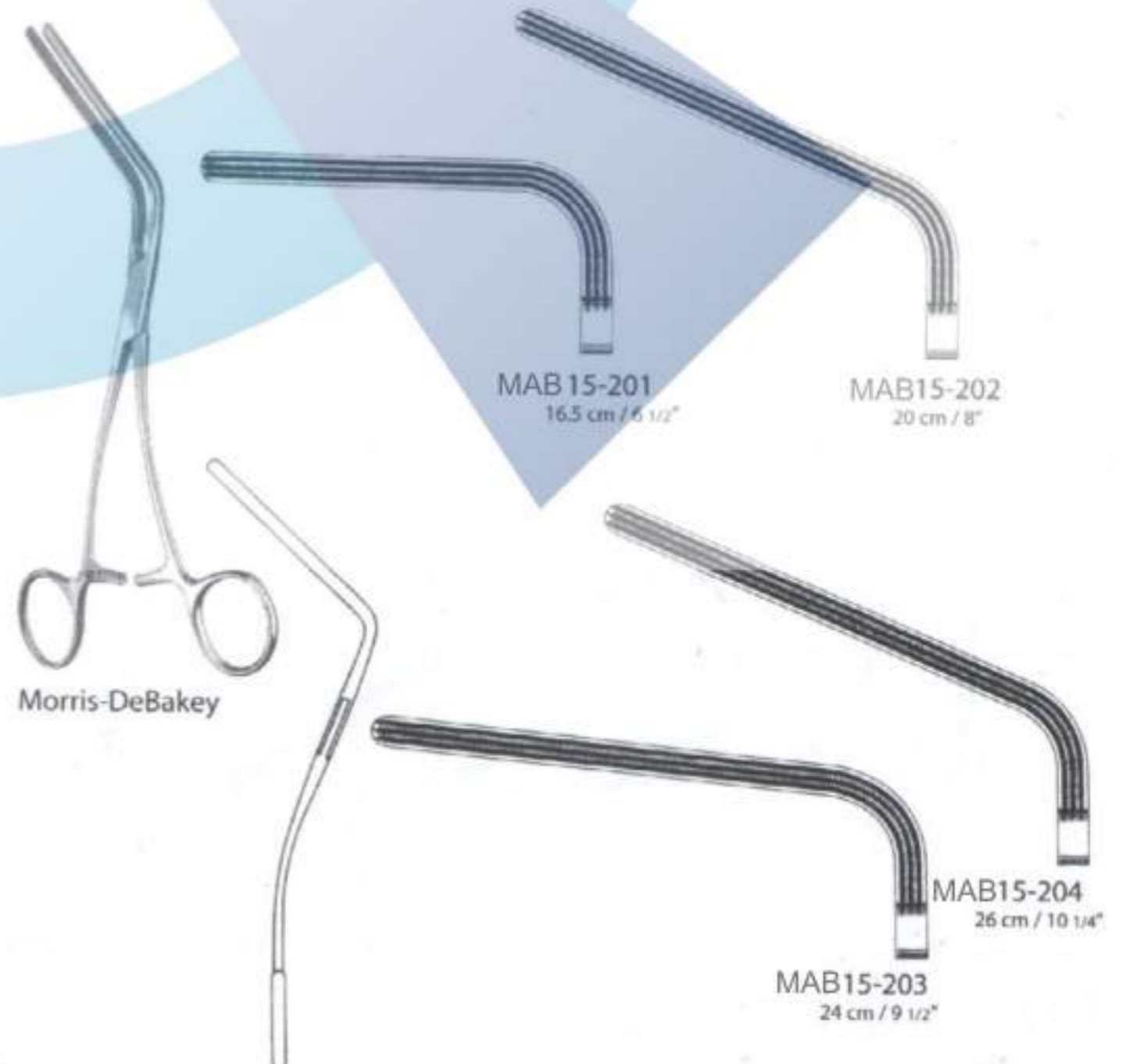

Herz- u. Gefäßchirurgie . Cardiovascular Surgery . Cirugia cardiovascular  
**Anastomosenklammern**  
**Anastomosis Clamps**  
**Pinzas para anastomosis**  
**Pinces-clamps pour anastomose**  
**Pinze per anastomosi**

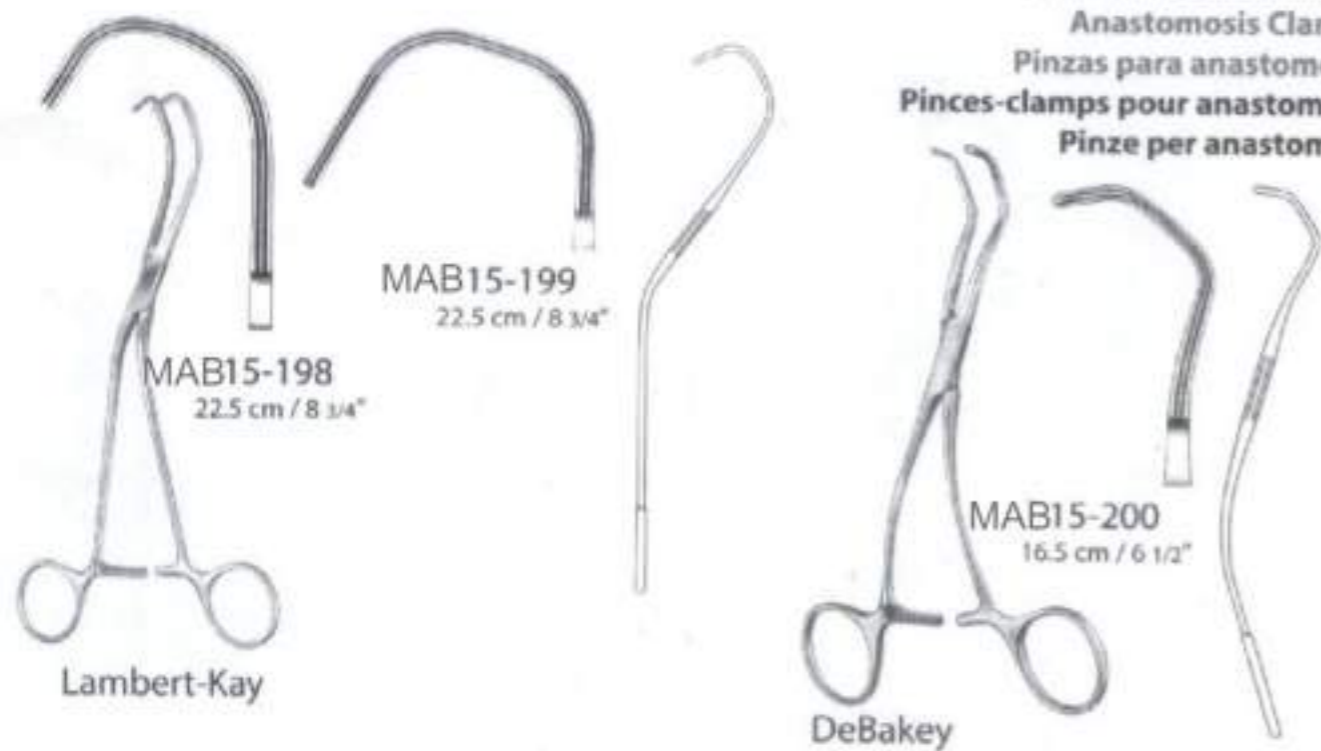



Herz- u. Gefäßchirurgie . Cardiovascular Surgery . Cirugia cardiovascular  
**Aneurysmklemmen**  
**Aneurysm Clamps**  
**Pinzas para aneurisma**  
**Pinces-clamps pour anévrisme**  
**Pinze per aneurisma**



MAB15-205  
23.5 cm / 9 1/4"

MAB15-206  
24.5 cm / 9 3/4"

MAB15-207  
25.5 cm / 10"

DeBakey-Bahnson

Herz-u. Gefäßchirurgie . Chirurgie cardio-vasculaire . Chirurgia cardiovascolare  
**Mehrzweck-Gefäßklemmen**  
**Multi purpose Vascular Clamps**  
**Pinzas vasculares de usos múltiples**  
**Pinces vasculaires universelles**  
**Pinze vascolari universali**

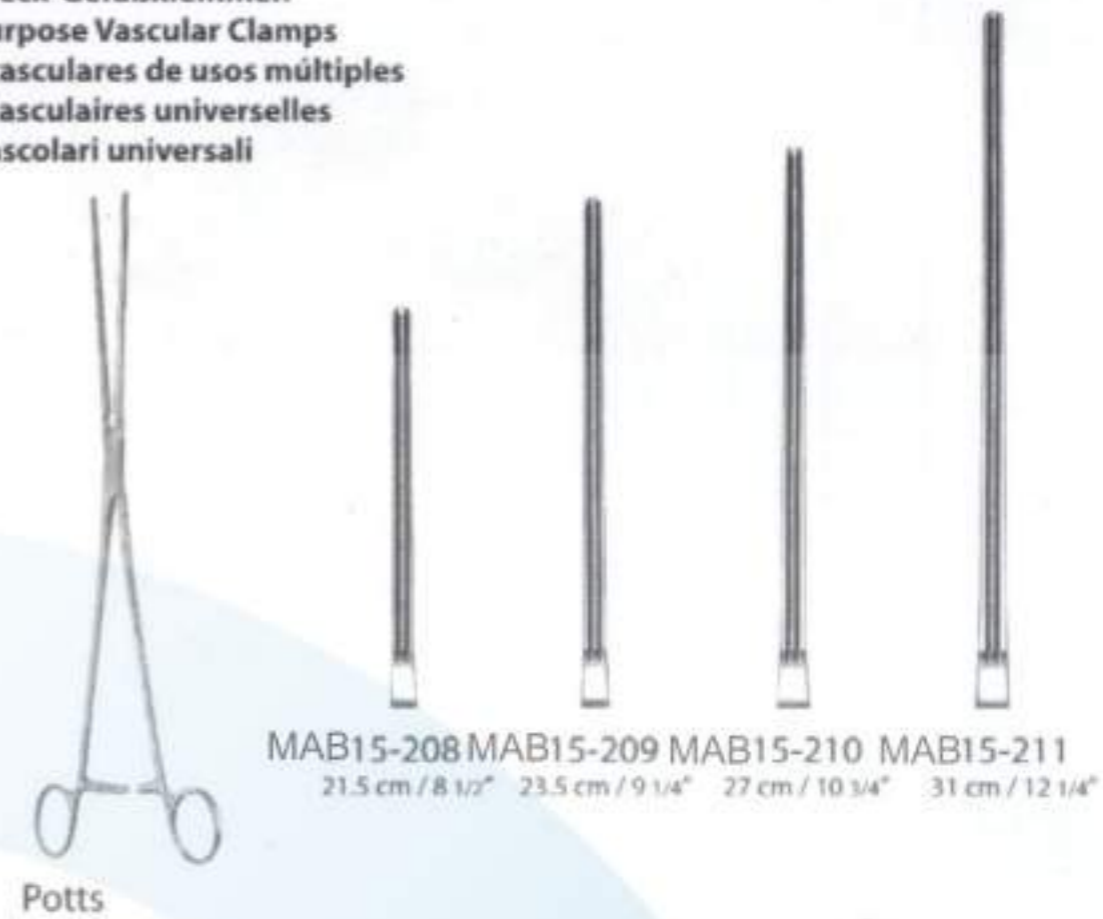

MAB15-208 MAB15-209 MAB15-210 MAB15-211  
 21.5 cm / 8 1/2" 23.5 cm / 9 1/4" 27 cm / 10 3/4" 31 cm / 12 1/4"

Potts



MAB15-212 MAB15-213 MAB15-214 MAB15-215  
 21 cm / 8 1/4" 23 cm / 9" 26 cm / 10 1/4" 30.5 cm / 12"

Potts

Herz- u. Gefäßchirurgie . Cardiovascular Surgery . Cirugia cardiovascular  
**Mehrzweck-Gefäßklemmen**  
**Multi purpose Vascular Clamps**  
**Pinzas vasculares de usos múltiples**  
**Pinces vasculaires universelles**  
**Pinze vascolari universali**

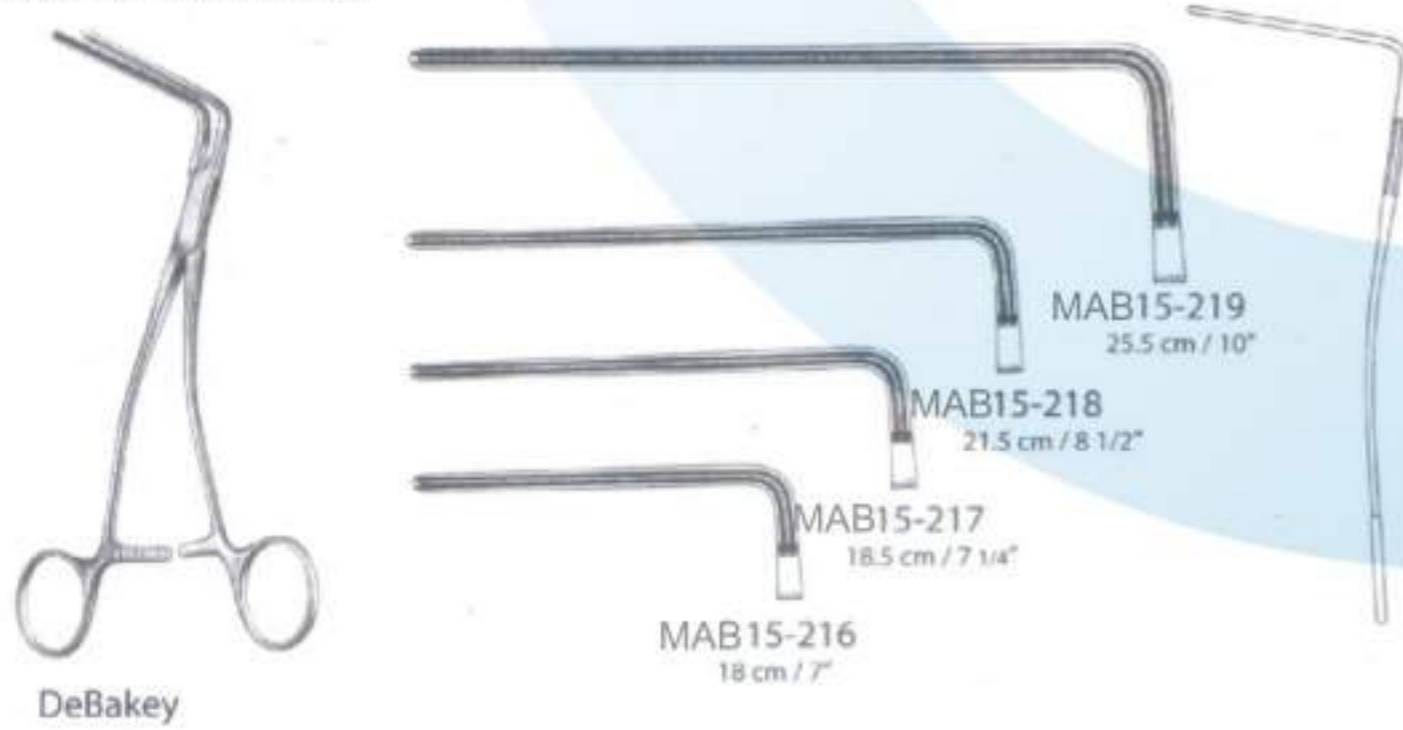

MAB15-219  
25.5 cm / 10"

MAB15-218  
21.5 cm / 8 1/2"

MAB15-217  
18.5 cm / 7 1/4"

MAB15-216  
18 cm / 7"

DeBakey

Herz-u. Gefäßchirurgie . Chirurgie cardio-vasculaire . Chirurgia cardiovascolare  
**Arterienklemmen**  
**Haemostatic Forceps**  
**Pinzas hemostáticas**  
**Pinces hémostatiques**  
**Pinze emostatiche**



MAB15-224 MAB15-225  
12.5 cm / 5" 12.5 cm / 5"

MAB15-226 MAB15-227 MAB15-228 MAB15-229  
 14.5 cm / 5 3/4" 16.5 cm / 6 1/2" 18.5 cm / 7 1/4" 20.5 cm / 8"

DeBakey-Mosquito

DeBakey-Pean



MAB15-220 MAB15-221 MAB15-222 MAB15-223  
 21 cm / 8 1/4" 22 cm / 8 3/4" 26 cm / 10 1/4" 31 cm / 12 1/4"

DeBakey



MAB15-230 MAB15-231 MAB15-232 MAB15-233  
 14.5 cm / 5 3/4" 16.5 cm / 6 1/2" 18.5 cm / 7 1/4" 20.5 cm / 8"

DeBakey-Pean



Herz- u. Gefäßchirurgie . Cardiovascular Surgery . Cirugía cardiovascular  
 Mehrzweck-Gefäßklemmen  
 Multi purpose Vascular Clamps  
 Pinzas vasculares de usos múltiples  
 Pincas vasculaires universelles  
 Pinze vascolari universali



Herz- u. Gefäßchirurgie . Chirurgie cardio-vasculaire . Chirurgia cardiovascolare  
 Mehrzweck-Gefäßklemmen, Anastomosenklemmen  
 Multi purpose Vascular Clamps, Anastomosis Clamps  
 Pinzas vasculares de usos múltiples, Pinzas para anastomosis  
 Pincas vasculaires universelles, Pincas pour anastomose  
 Pinze vascolari universali, Pinze per anastomosi



Herz- u. Gefäßchirurgie . Cardiovascular Surgery . Cirugía cardiovascular  
 Kinder-Gefäßklemmen  
 Pediatric Vascular Clamps  
 Pinzas vasculares pediátricas  
 Pincas vasculaires pédiatriques  
 Pinze vascolari pediatriche



Herz- u. Gefäßchirurgie . Chirurgie cardio-vasculaire . Chirurgia cardiovascolare  
 Kinder-Gefäßklemmen  
 Pediatric Vascular Clamps  
 Pinzas vasculares pediátricas  
 Pincas vasculaires pédiatriques  
 Pinze vascolari pediatriche

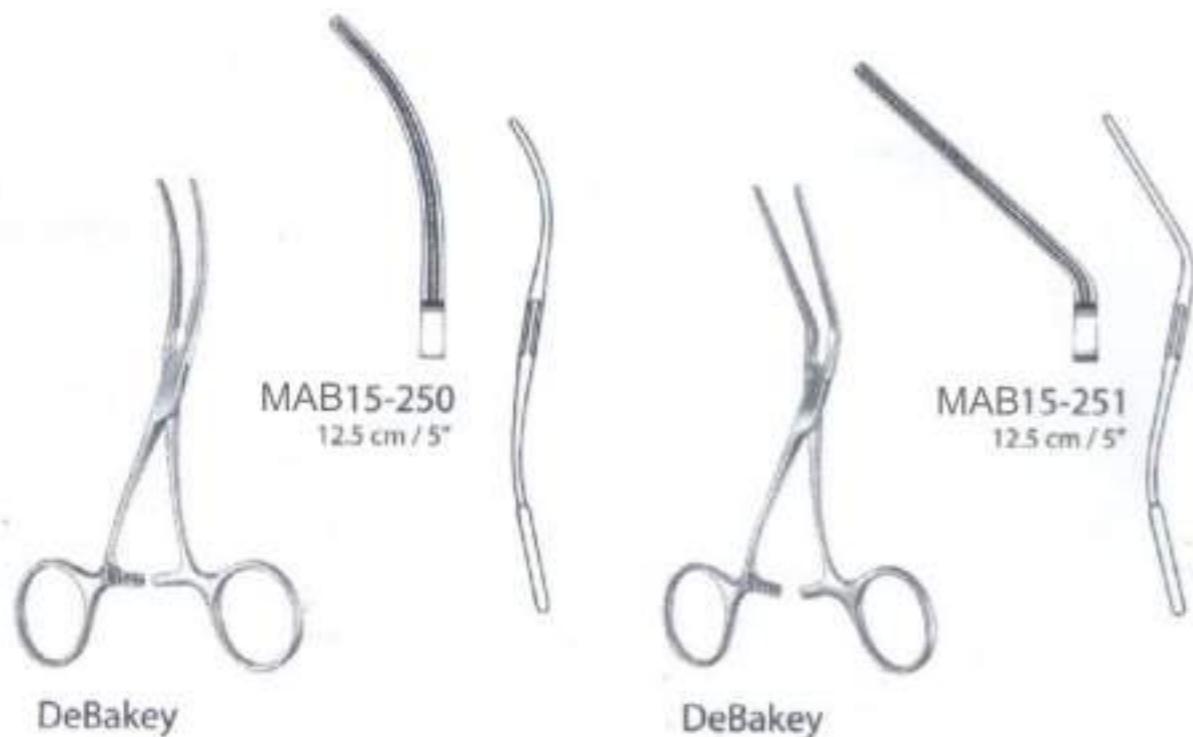



Cardiovascular Surgery . Cirugia cardiovascular

Chirurgie cardio-vasculaire . Chirurgia cardiovascolare

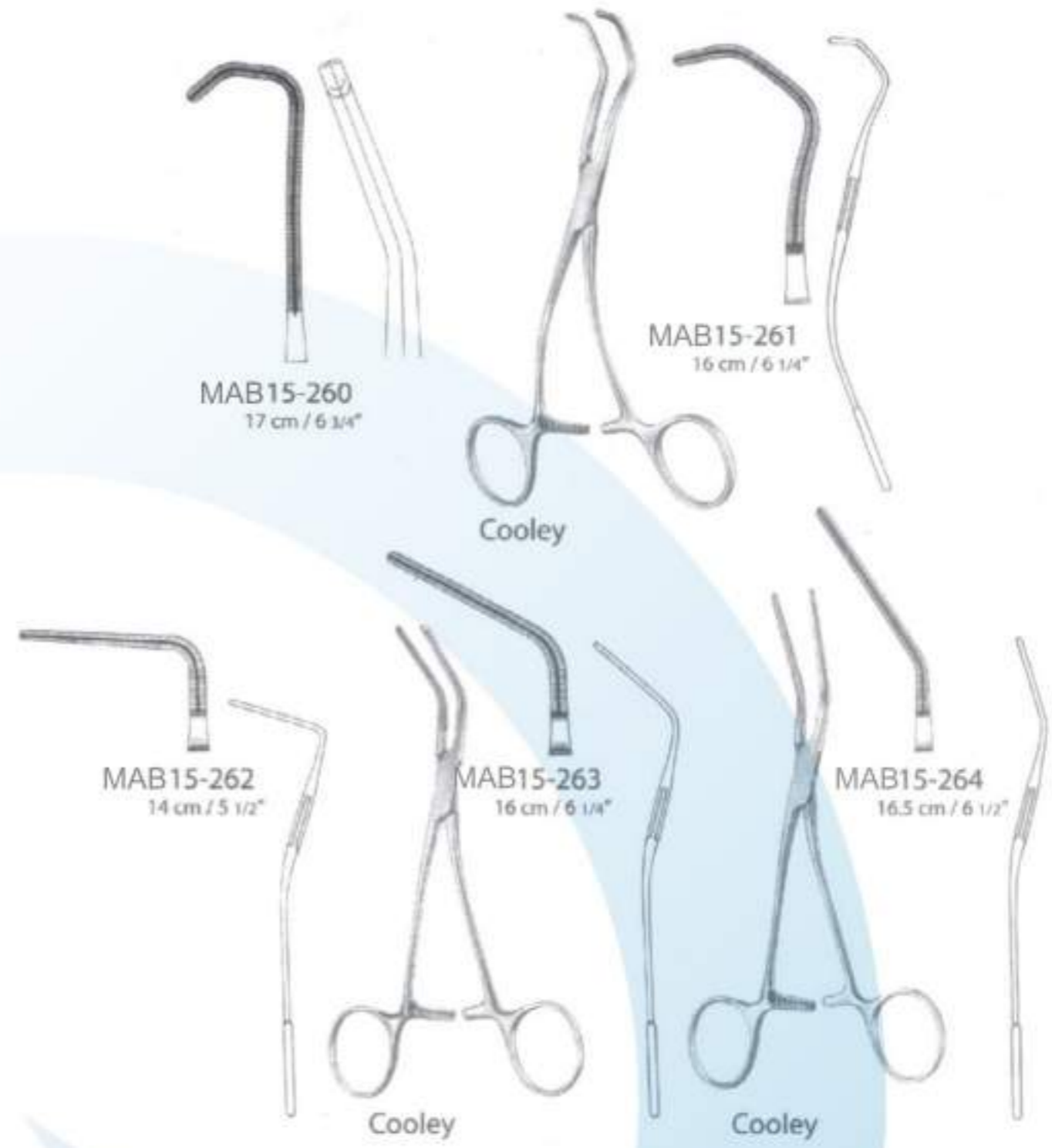
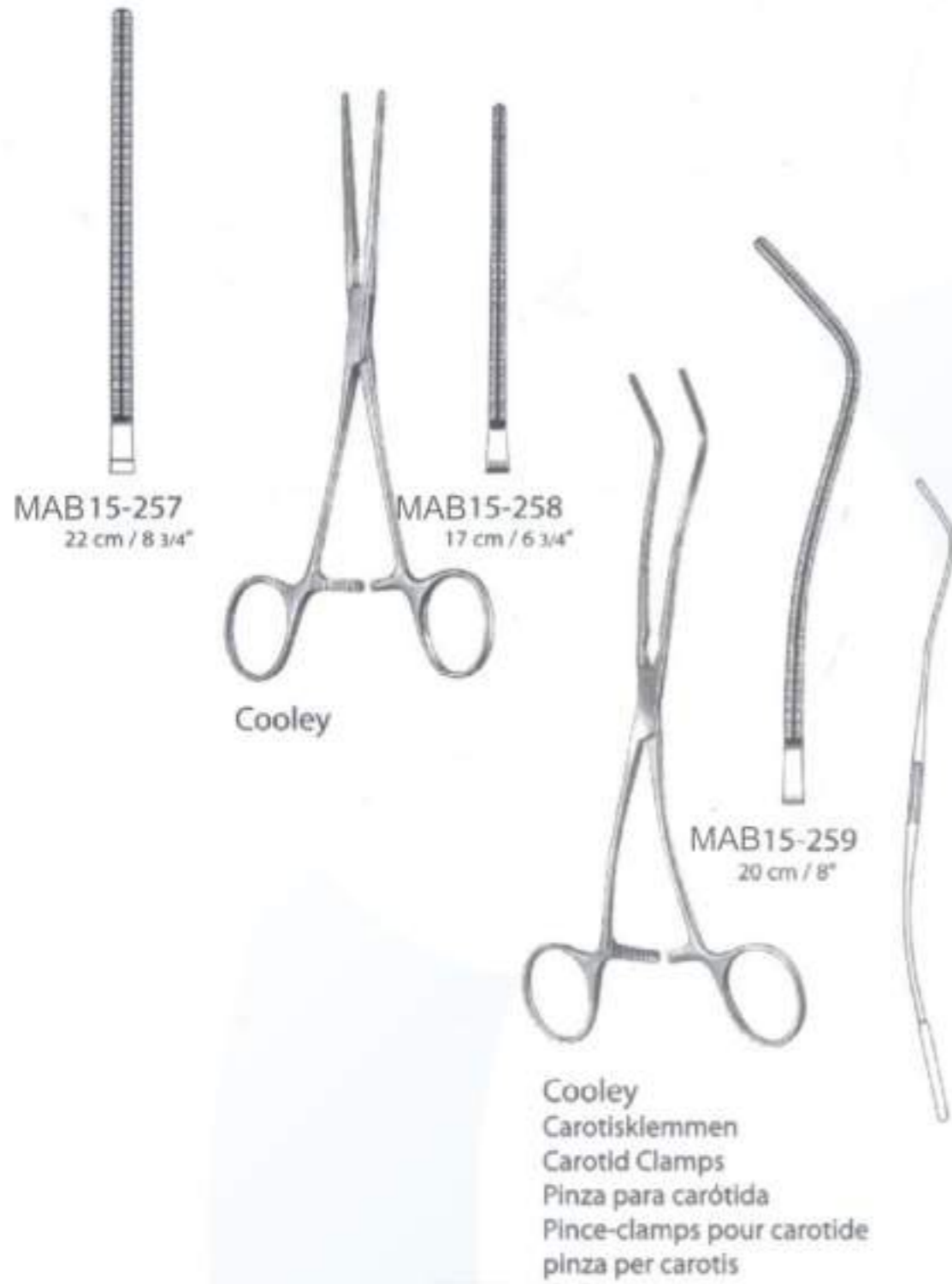

Cardiovascular Surgery . Cirugia cardiovascular

Chirurgie cardio-vasculaire . Chirurgia cardiovascolare





Herz- u. Gefäßchirurgie . Cardiovascular Surgery . Cirugía cardiovascular  
**Aorta-Dilatatoren**  
**Aortic Dilators**  
**Dilatadores aórticos**  
**Dilatateurs pour aorte**  
**Dilatatori per aorta**



**Tubbs**  
**MAB15-274**  
 Spreizweite 8 -42 mm, mit Feststellschraube  
 Spreading 8 -42 mm, with fixation screw  
 abertura 8 -42 mm, con tornillo de ajuste  
 ouverture 8 -42 mm, avec vis de fixation  
 apertura totale 8 -42 mm, con vite di fissazione

für Mitralstenosen  
 for mitral stenosis  
 para estenosis mitral  
 pour sténoses mitrales  
 per stenosi mitrali



**Cooley**  
**MAB15-275**  
 Spreizweite 8 - 15 mm, mit Gewindesperre  
 Spreading 8 - 15 mm, with thread fixation  
 abertura 8 - 15 mm, con fijación de rosca  
 ouverture 8 - 15 mm, avec fixation filetée  
 apertura totale 8 - 15 mm, con fissazione a filettatura

für Mitralstenosen  
 for mitral stenosis  
 para estenosis mitral  
 pour sténoses mitrales  
 per stenosi mitrali

Herz- u. Gefäßchirurgie . Chirurgie cardio-vasculaire . Chirurgia cardiovascolare  
**Gefäßdilatoren**  
**Vascular Dilators**  
**Dilatadores vasculares**  
**Dilatateurs vasculaires**  
**Dilatatori vascolari**

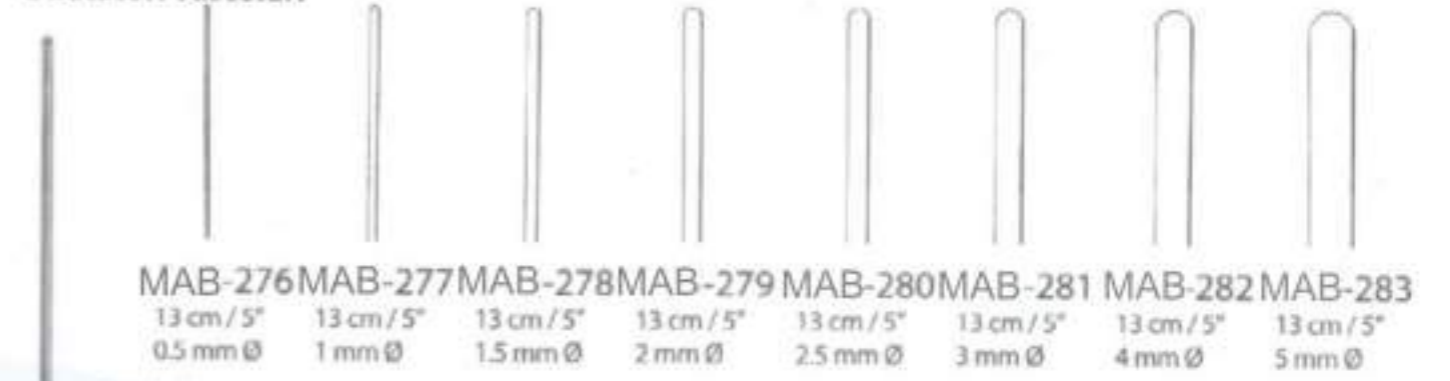

**Cooley**  
 biegsam, Silber  
 malleable, silver  
 maleable, silver  
 malléable, argente  
 flessibile, argento



**DeBakey**  
 biegsam  
 malleable  
 maleable  
 malléable  
 flessibile



Herz- u. Gefäßchirurgie . Cardiovascular Surgery . Cirugía cardiovascular  
**Tunnelier-Set**  
**Tunneling Set**  
**Juego para tunelar**  
**Jeu pour tunneliser**  
**Set per tunnelare**

**MAB-296**  
 Schraubaufsatz für Venen  
 Vein Tip  
 Cabeza para venas  
 Embout pour veines  
 Tata adattatore veni  
 mit Knopf, Luer-Lock Ansatz  
 with button, Luer-Lock cone  
 con botón, cono Luer-Lock  
 avec bouton, cône Luer-Lock  
 con bottone, cono Luer-Lock

**MAB-297**  
 Luer-Schraubadapter  
 Luer Adaptor  
 Adaptador Luer  
 Adaptateur Luer  
 Adattatore Luer  
 Adattatore Luer  
 Luer-Lock Ansatz  
 Luer-Lock cone  
 cono Luer-Lock  
 cône Luer-Lock  
 cono Luer-Lock

**MAB-298**  
 Halteplatte für Aufsätze  
 Plate for Tips  
 Soporte para cabezas  
 Support pour embouts  
 Supporto per punte

**S 15-299**  
 Metallbehälter  
 Metal Case  
 Caja metálica  
 Boîte métal  
 contenitore metallico  
 55 x 11.5 x 3.5 cm

Herz- u. Gefäßchirurgie . Cardiovascular Surgery . Cirugía cardiovascular  
**Intimaspatel, Gefäßdissektoren**  
**Intima Spatulas, Vascular Dissectors**  
**Espátulas para la íntima, Disecadores vasculares**  
**Spatules pour la tunique interne, Dissecteurs vasculaires**  
**Spatole per intima, Dissettori vascolari**



**Intimaspatel**  
**Intima Spatula**  
 Espátula para la íntima  
 Spatule pour la tunique interne  
 Spatola per intima

stumpf  
 blunt  
 romo  
 mousse  
 smusso

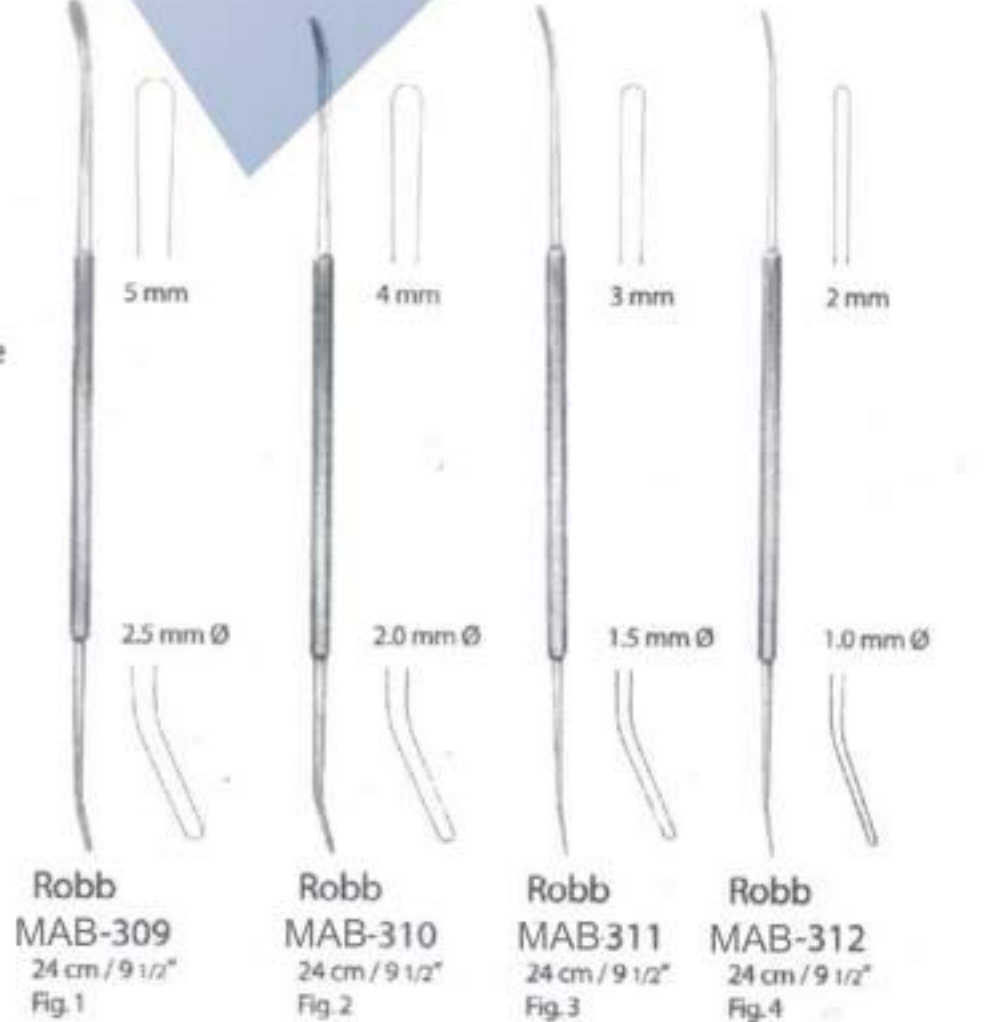

Herz- u. Gefäßchirurgie . Chirurgie cardio-vasculaire . Chirurgia cardiovascolare  
**Fasziotomiemesser, Fasziotomiespatel**  
**Fasciotomy Knife, Fasciotomy Spatulas**  
**Cuchillo para fasciotomía, Espátulas para fasciotomía**  
**Couteau pour fasciotomie, Spatule pour fasciotomie**  
**Bisturi per fasziotomia, Spatole per fasciotomia**

**Hach**  
**MAB-300**  
 30 cm / 11 3/4"  
 mit Kunststoffgriff  
 with plastic handle  
 con mango plástico  
 avec manche en matière plastique  
 con manico in plastica

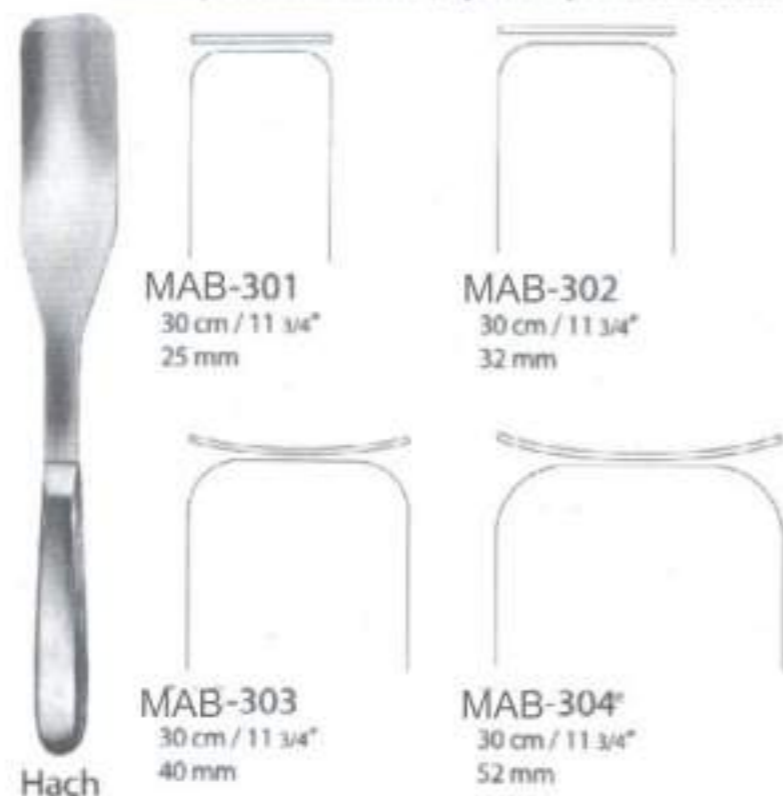



Herz-u. Gefäßchirurgie . Chirurgie cardio-vasculaire . Chirurgia cardiovascolare  
 Nervhäkchen, Tourniquets  
 Nerve Hooklets, Tourniquets  
 Ganchitos para nervios, Tourniquets  
 Crochets pour les nerfs, Tourniquets  
 Uncini per nervi, Tornichetti

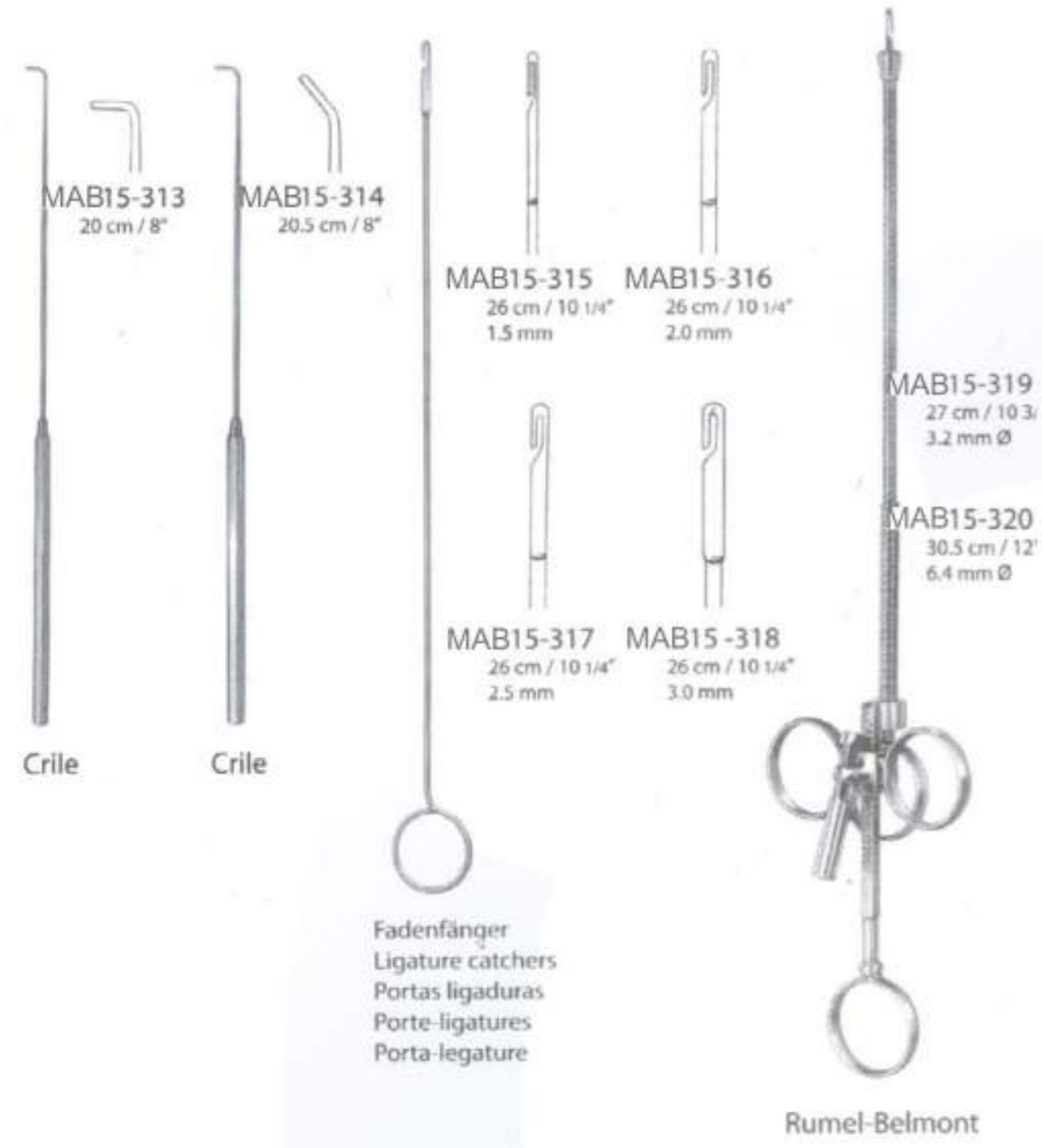

Herz-u. Gefäßchirurgie . Cardiovascular Surgery . Cirugía cardiovascular  
 Aortaklemmen  
 Aortic Clamps  
 Pinzas aórticas  
 Pincas-clamps pour aorte  
 Pinze per aorta



Herz-u. Gefäßchirurgie . Chirurgie cardio-vasculaire . Chirurgia cardiovascolare  
 Kinder-Gefäßklemmen  
 Pediatric Vascular Clamps  
 Pinzas vasculares pediátricas  
 Pincas vasculaires pédiatriques  
 Pinze vascolari pediatriche

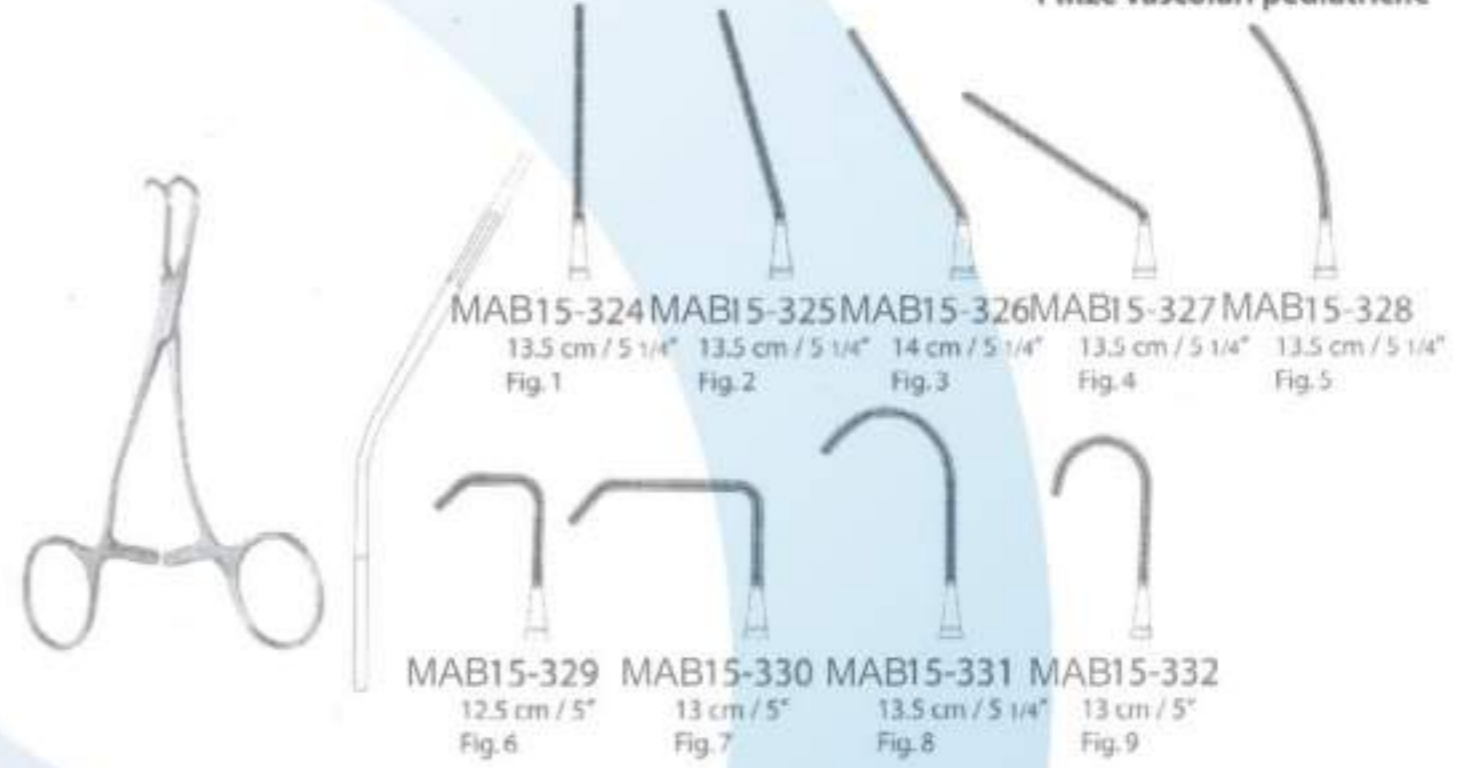

Herz-u. Gefäßchirurgie . Cardiovascular Surgery . Cirugía cardiovascular  
 Kinder-Gefäßklemmen  
 Pediatric Vascular Clamps  
 Pinzas vasculares pediátricas  
 Pincas vasculaires pédiatriques  
 Pinze vascolari pediatriche

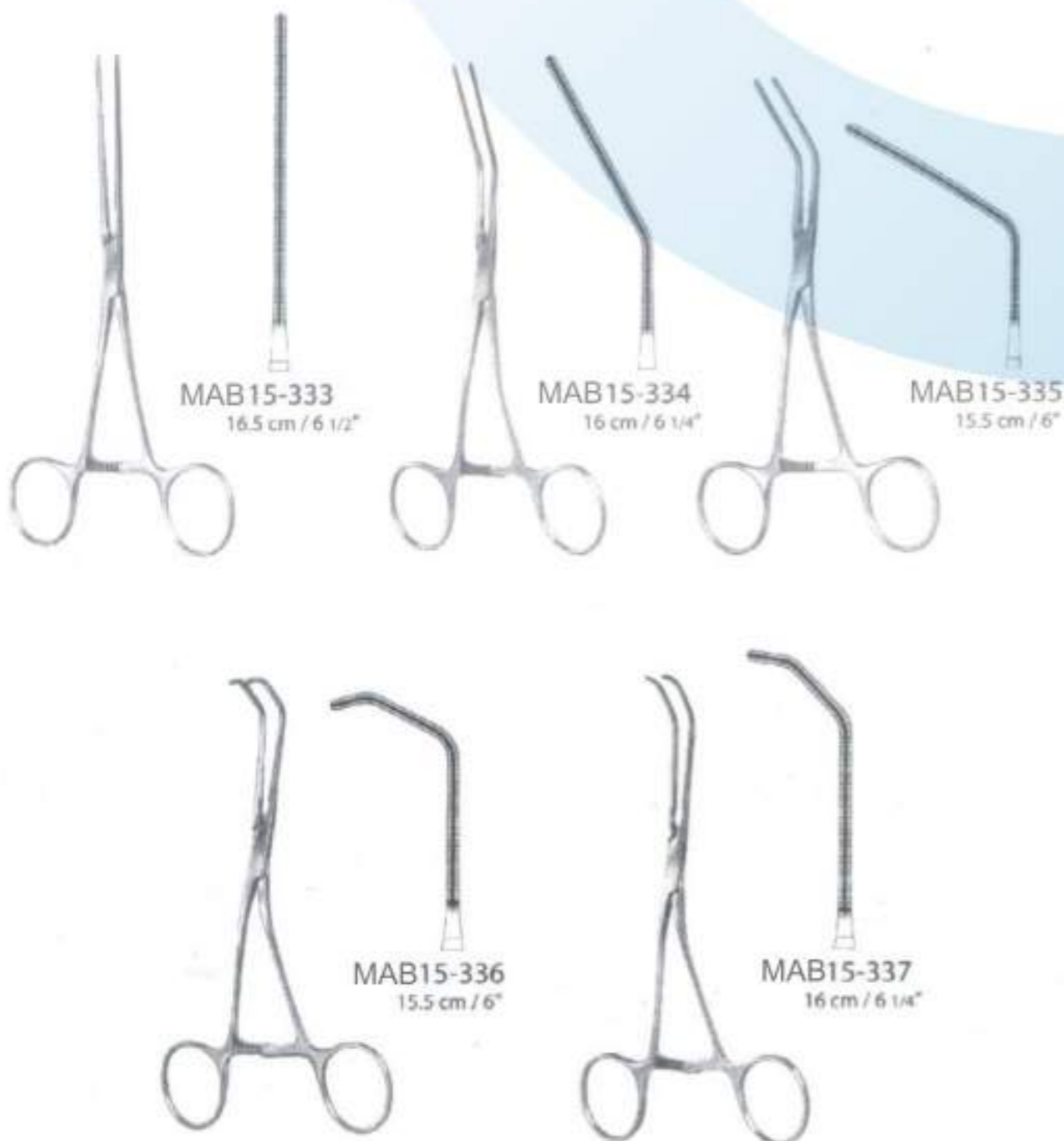

Herz-u. Gefäßchirurgie . Chirurgie cardio-vasculaire . Chirurgia cardiovascolare  
 Neonatal-Gefäßklemmen  
 Neonatal Vascular Clamps  
 Pinzas vasculares para recién nacidos  
 Pincas vasculaires pour nouveaux nés  
 Pinze vascolari per neonati





## MAB 16



Neurochirurgie, Laminektomie  
 Neurosurgery, Laminectomy  
 Neurocirugia, Laminectomia  
 Neurochirurgie, Laminectomie  
 Neurochirurgia, Laminectomia

Neurochirurgie, Laminektomie . Neurosurgery, Laminectomy . Neurocirugia, Laminectomia  
**Drahtsägen**  
**Wire Saws**  
**Sierras de hilo**  
**Fils-scies**  
**Fili sega**



Neurochirurgie, Laminektomie . Neurochirurgie, Laminectomy . Neurochirurgia, Laminectomia

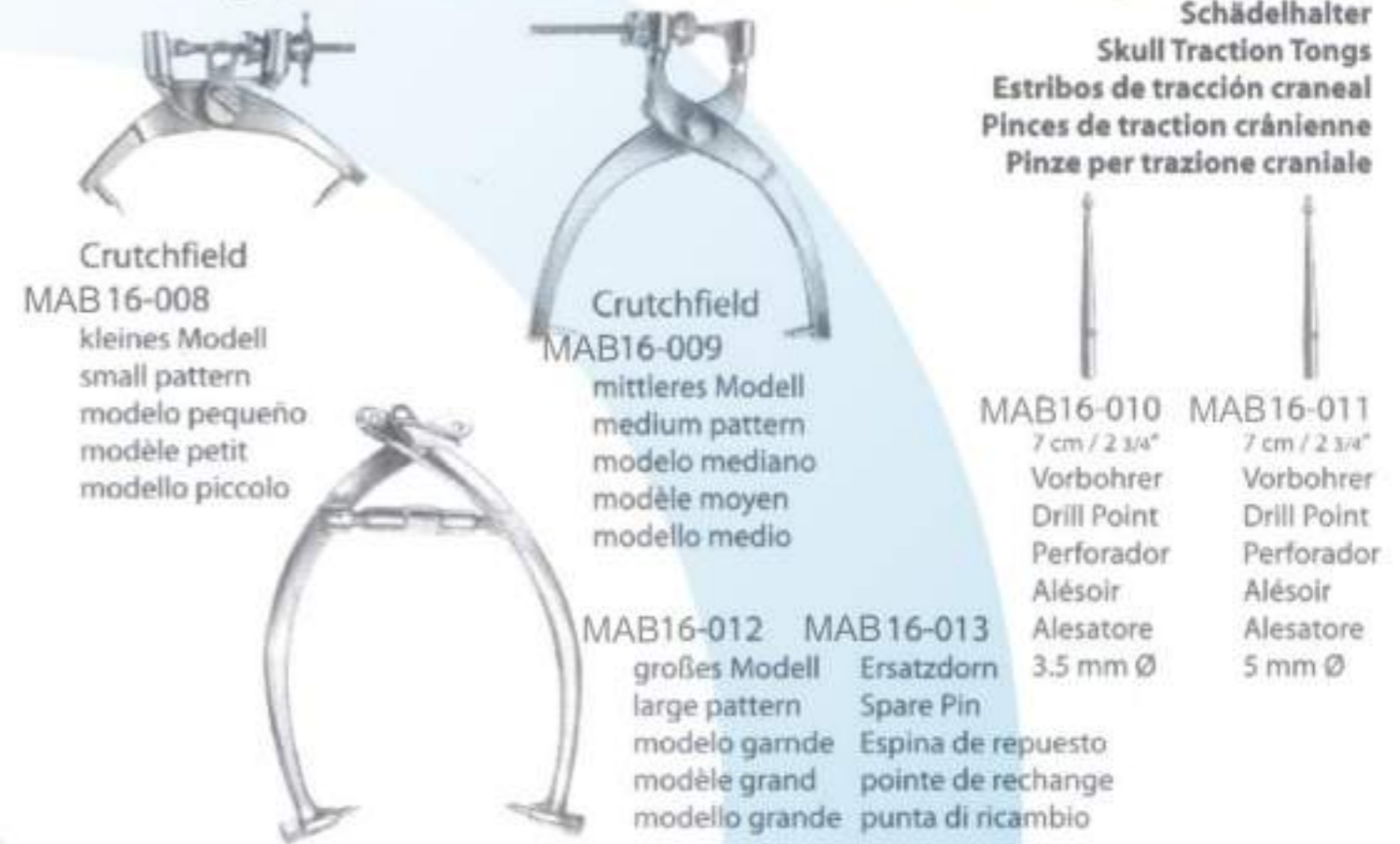

Neurochirurgie, Laminektomie . Neurosurgery, Laminectomy . Neurocirugia, Laminectomia  
**schädelzangen**  
**Cranial Rongeurs**  
**Pinzas sacabocados craneales**  
**Pinces emporte-pièces crâniennes**  
**Pinze per craniectomia**

Neurochirurgie, Laminektomie . Neurochirurgie, Laminectomy . Neurochirurgia, Laminectomia  
**Clips und Anlegezangen**  
**Clips and Applying Forceps**  
**Grapas y pinzas aplicadoras**  
**Clips et pinces pour appliquer**  
**Agrafes e pinze per applicare**

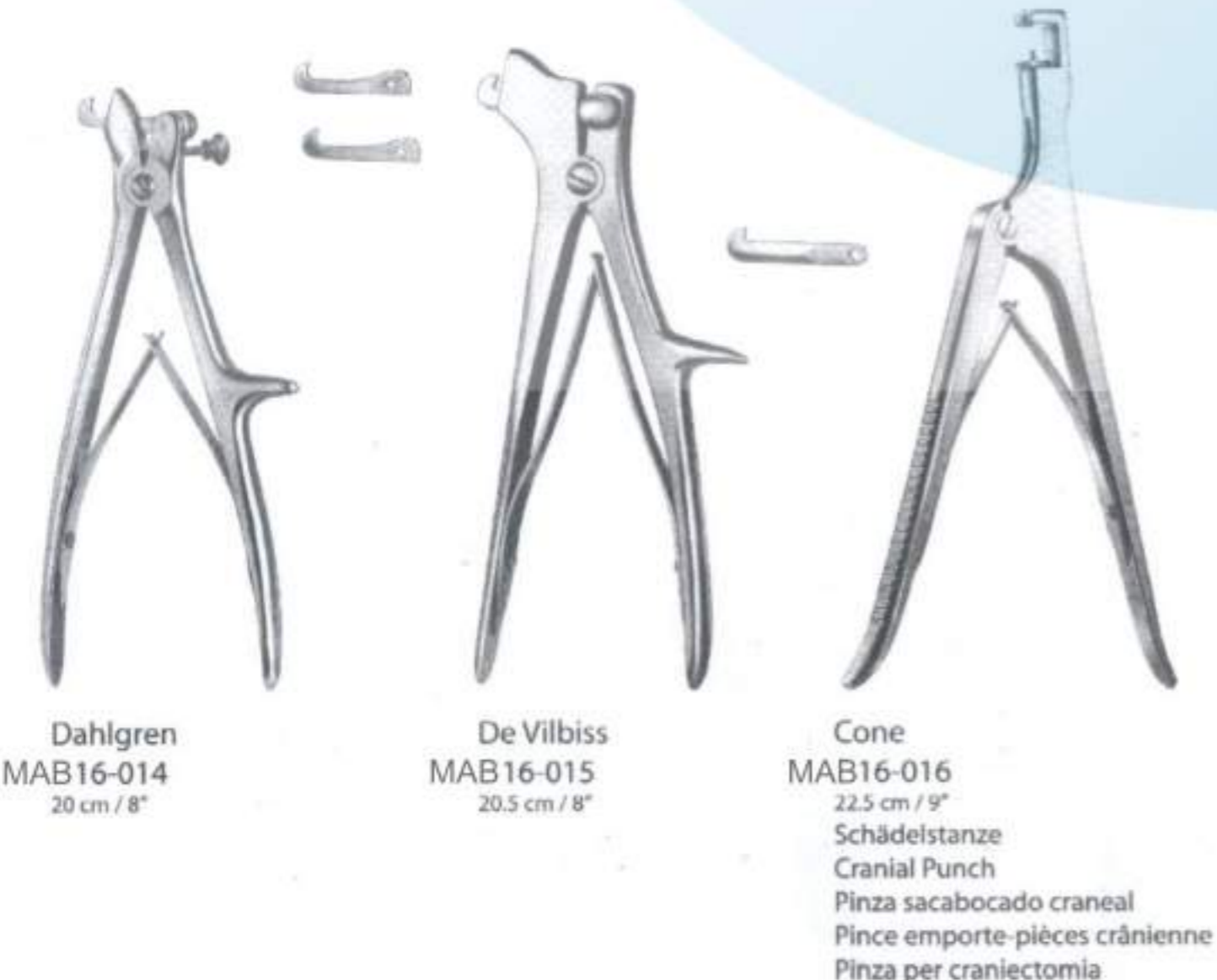

Dahlgren  
MAB16-014  
20 cm / 8"

De Vilbiss  
MAB16-015  
20.5 cm / 8"

Cone  
MAB16-016  
22.5 cm / 9"  
Schädelstanze  
Cranial Punch  
Pinza sacabocado craneal  
Pince emporte-pièces crânienne  
Pinza per craniectomia

MAB16-017  
Olivecrona-Toennis  
Klammerzange  
Clip Applying Forceps  
Pinza para colocar grapas  
Pince pour poser les agrafes argent  
Pinza per applicare le agrafe di argento

McKenzie  
MAB16-018  
18.5 cm / 7 1/4"  
Klammerzange  
Clip Applying Forceps  
Pinza clipadora  
Pince pour poser les agrafes  
Pinza per applicare le agrafe

Raney  
MAB16-019  
15.5 cm / 6"  
Anlege- und Abnehmzange  
Applying/Removal Forceps  
Pinza para aplicar y quitar agrafes  
Pince pour appliquer et enlever les clips  
hémostatiques du cuir  
Pinza per applicare e togliere le agrafe  
emostatiche al cuoio capelluto



Neurochirurgie, Laminektomie . Neurosurgery, Laminectomy . Neurocirugia, Laminectomia  
 Duradissektoren  
 Dura Dissectors  
 Discadores para duramadre  
 Dissecteurs à dure-mère  
 Dissettori per la dura-madre

Neurochirurgie, Laminektomie . Neurosurgery, Laminectomy . Neurocirugia, Laminectomia  
 Duradissektoren  
 Dura Dissectors  
 Discadores para duramadre  
 Dissecteurs à dure-mère  
 Dissettori per la dura-madre

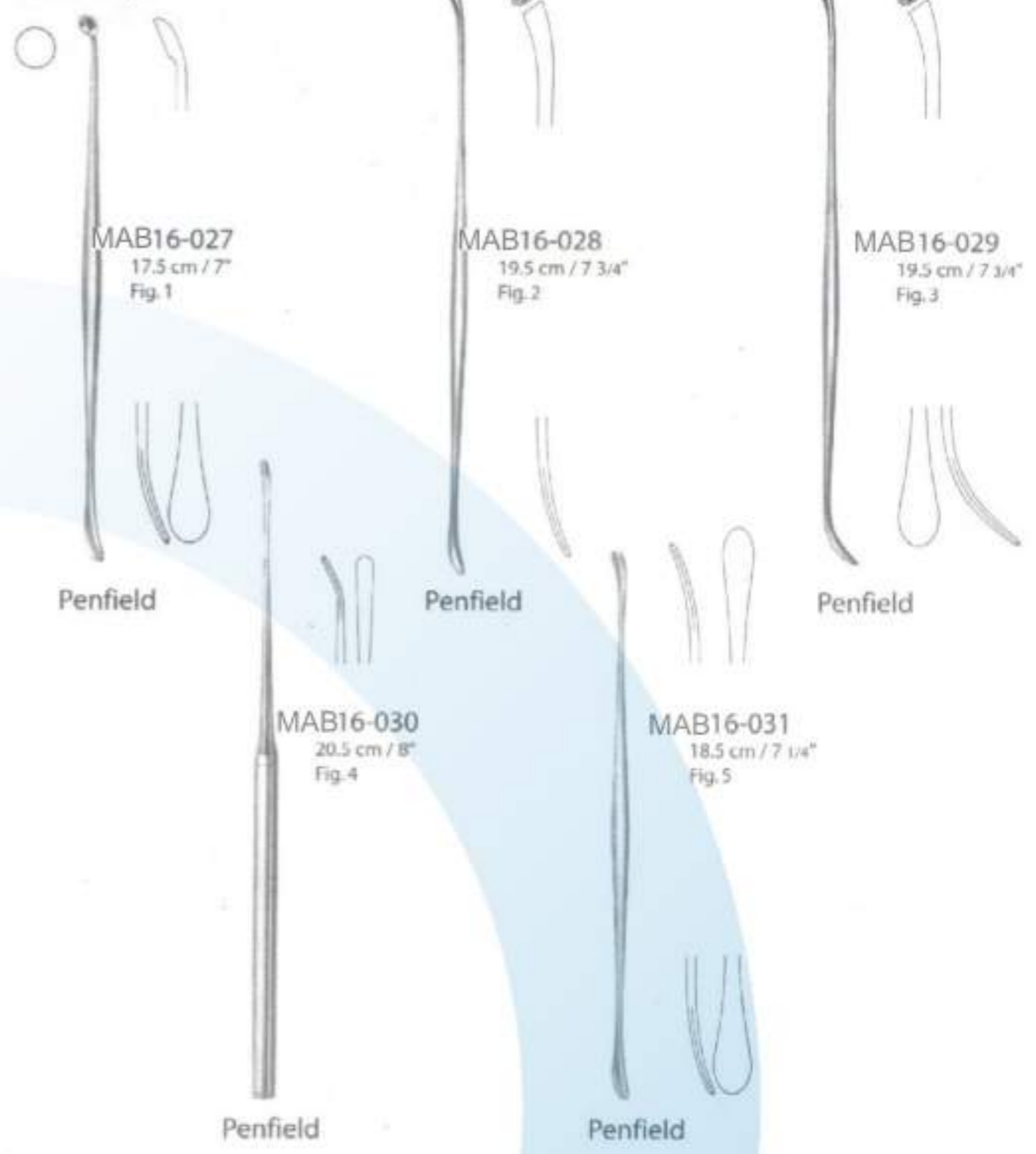
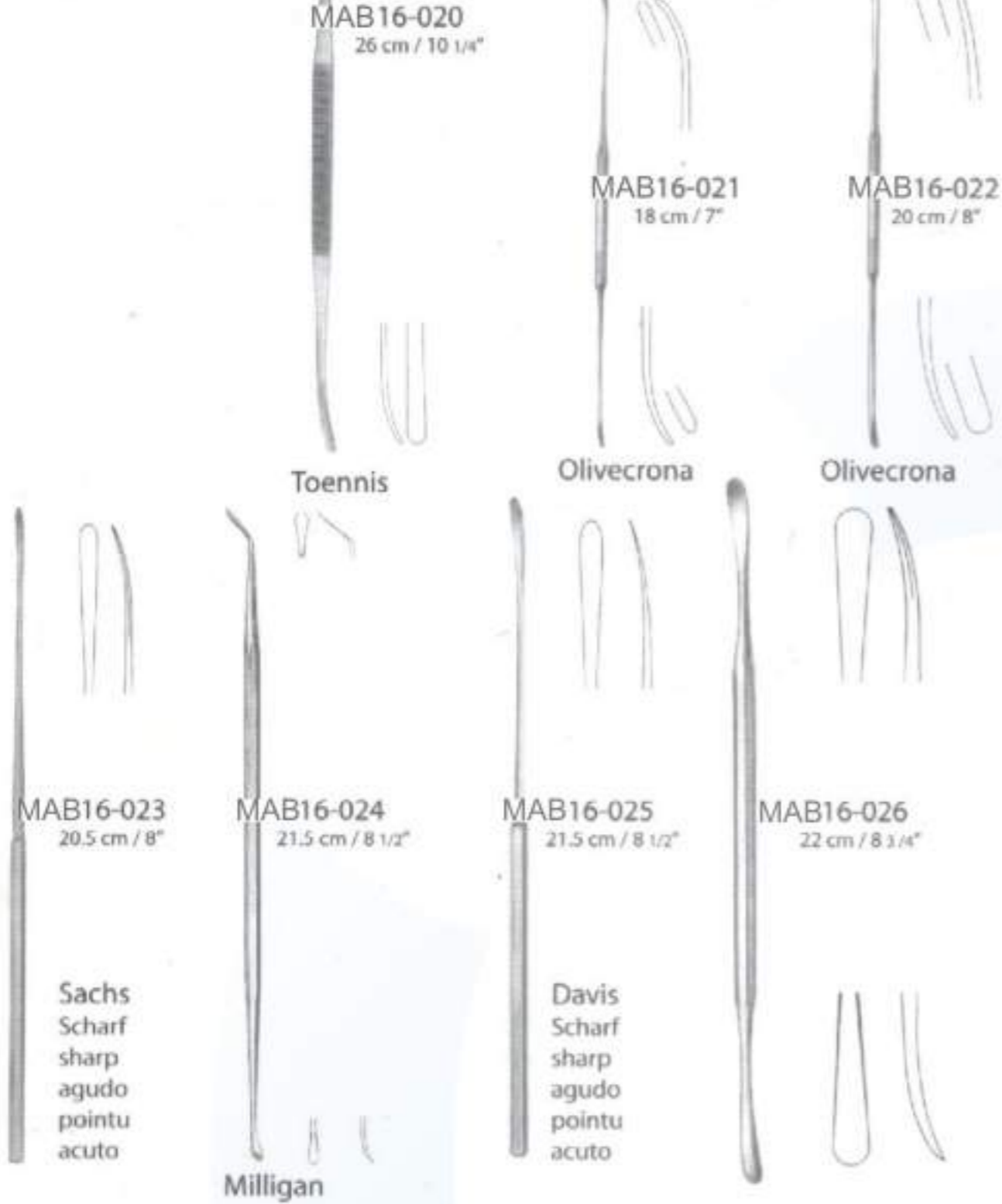

Neurochirurgie, Laminektomie . Neurochirurgie, Laminektomie . Neurochirurgia, Laminectomia  
 Duradissektoren, Nervwurzelhaken  
 Dura Dissectors, Nerve Root Retractors  
 Discadores para duramadre, Separadores para la raíz de nervio  
 Dissecteurs à dure-mère, Retracteurs pour racines nerveuses  
 Dissettori per la dura-madre, Uncini per le radici die nervi

Neurochirurgie, Laminektomie . Neurosurgery, Laminectomy . Neurocirugia, Laminectomia  
 Hirnspatel  
 Brins Spatulas  
 Espátulas cerebrales  
 Spatules cérébrales  
 Spatole cerebrali

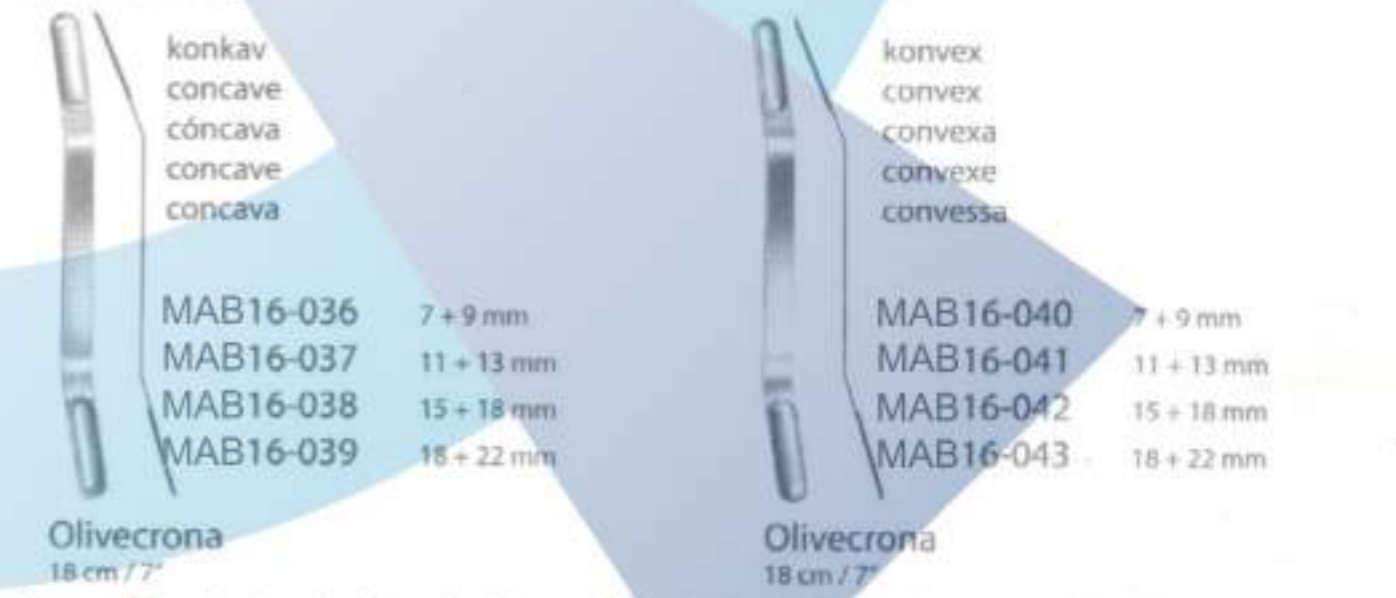
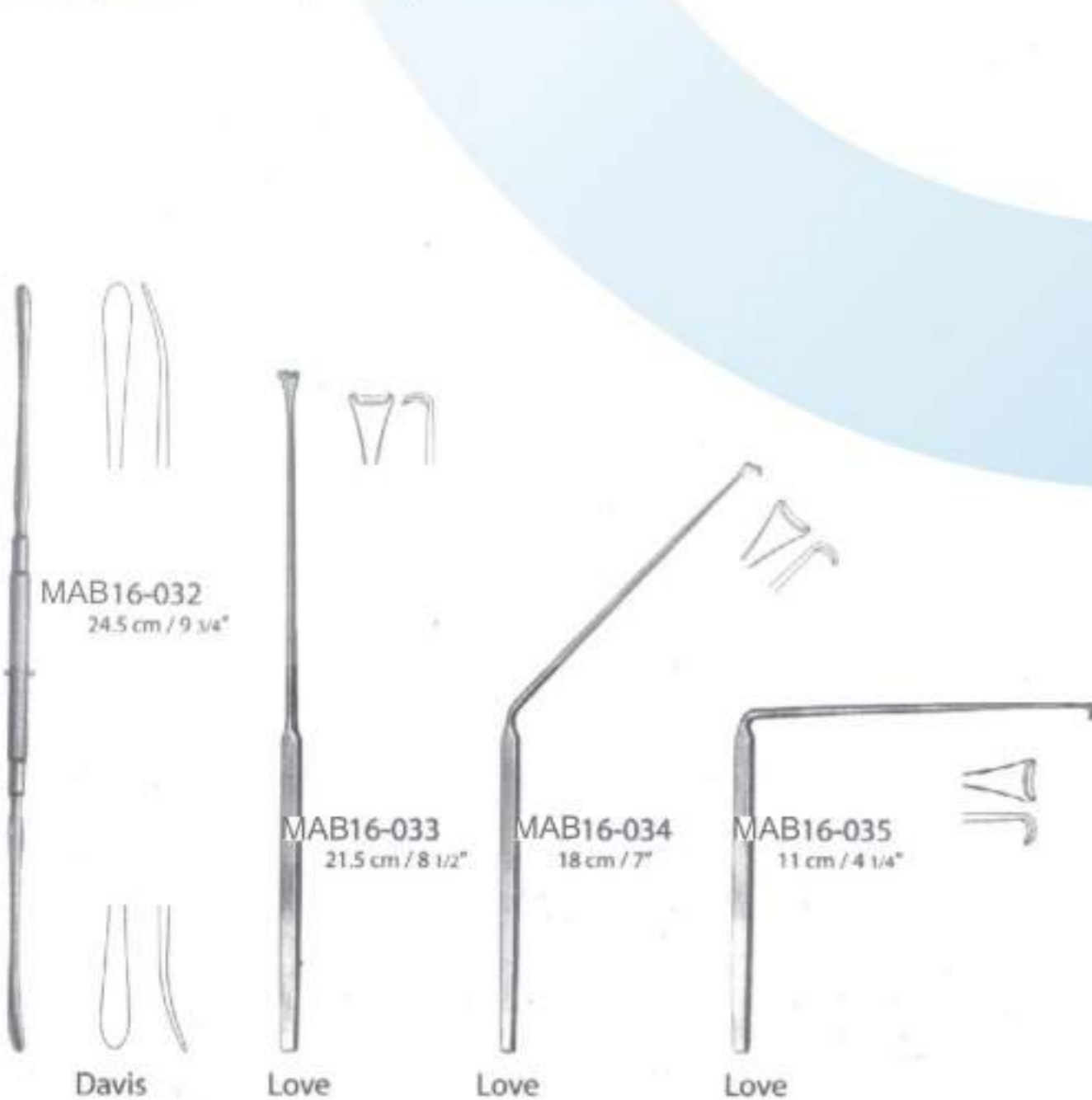

Neurochirurgie, Laminektomie . Neurochirurgie, Laminektomie . Neurochirurgia, Laminectomia  
 Nervwurzelhaken  
 Nerve Root Retractors  
 Separadores para la raíz de nervio  
 Retracteurs pour racines nerveuses  
 Uncini per le radici die nervi





Neurochirurgie, Laminektomie . Neurosurgery, Laminectomy . Neurocirugía, Laminectomía  
 Nervhaken  
 Nerve Hooks  
 Ganchos para nervios  
 Crochets à nerfs  
 Uncini per nervi

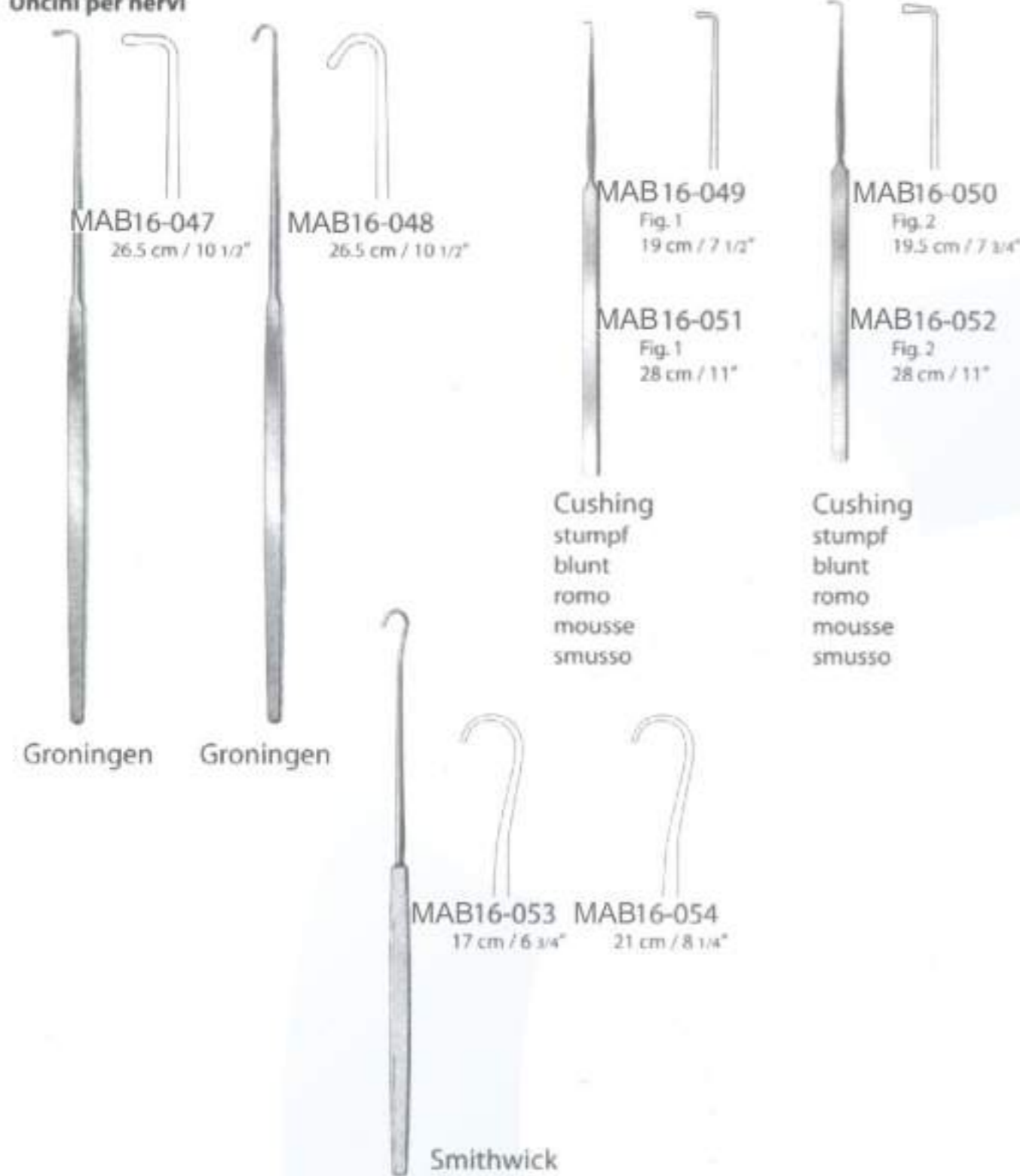

Neurochirurgie, Laminektomie . Neurochirurgie, Laminectomy . Neurocirurgia, Laminectomia  
 Duramesser, Durahaken  
 Dura Knives, Dura Hooks  
 Cuchillos para duramadre, Ganchos para duramadre  
 Couteaux pour dure-mère, Crochets pour dure-mère  
 Bisturi per dura-madre, Uncini per dura-madre



Neurochirurgie, Laminektomie . Neurosurgery, Laminectomy . Neurocirugía, Laminectomia  
 Durahaken, Nerv- und Gefäßhaken  
 Dura Hooks, Nerve and Vessel Hooklets  
 Ganchos para duramadre, Ganchitos para nervios y vasos  
 Crochets pour dure-mère, Crochets à nerfs et à vaisseaux  
 Uncini per dura-madre, Uncini per nervi e vasi



Neurochirurgie, Laminektomie . Neurochirurgie, Laminectomy . Neurocirurgia, Laminectomia  
 Wirbelkörperspreizer  
 Lamina Spreaders  
 Separadores para cuerpos vertebrales  
 Ecarteurs pour corps vertébraux  
 Separatori per vertebre

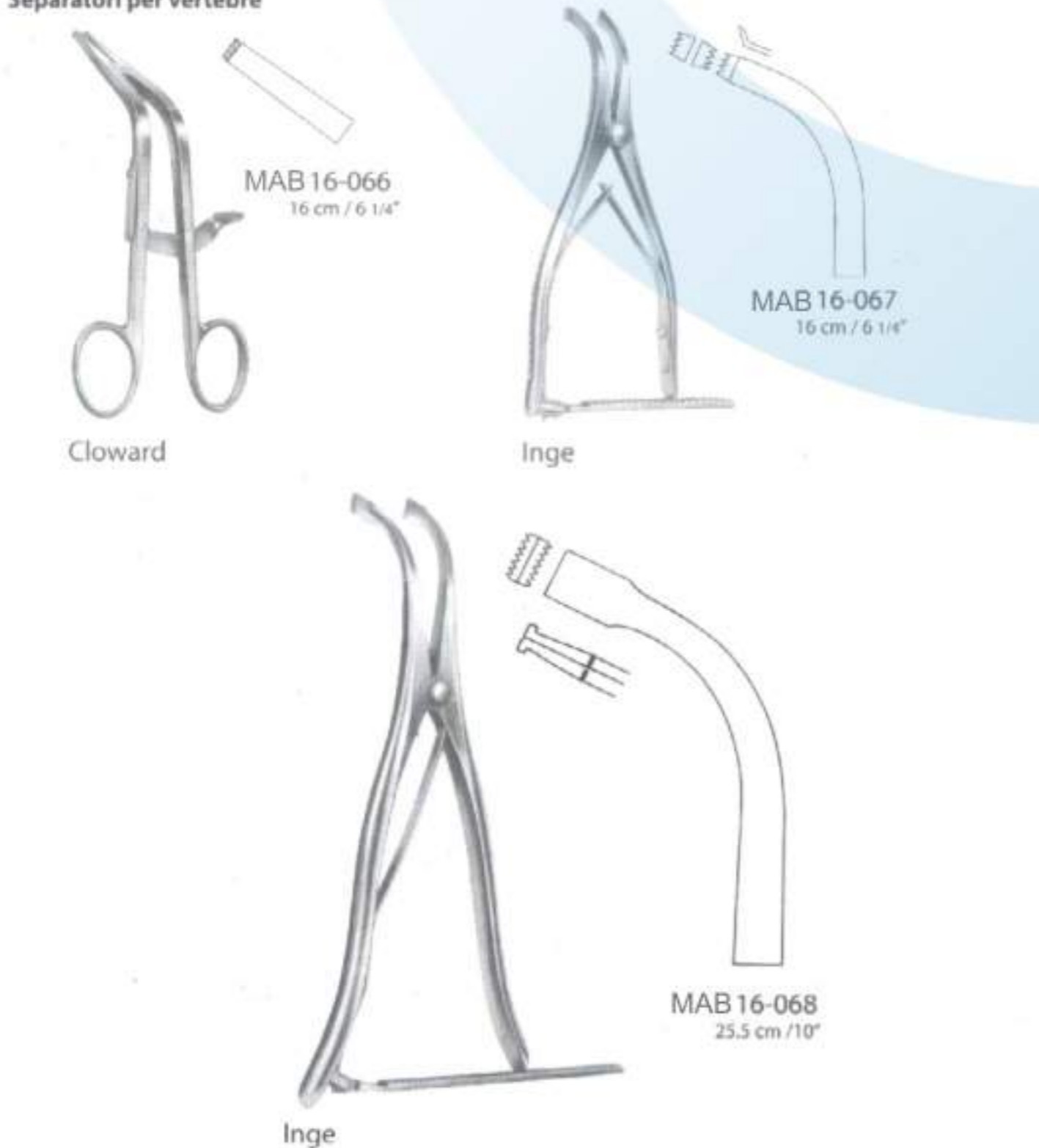

Neurochirurgie, Laminektomie . Neurosurgery, Laminectomy . Neurocirurgia, Laminectomia  
 Laminektomiestanzen  
 Laminectomy Punches  
 Pinzas cortantes para laminectomía  
 Pinces emporte-pièces à laminectomie  
 Pinze taglianti per laminectomia

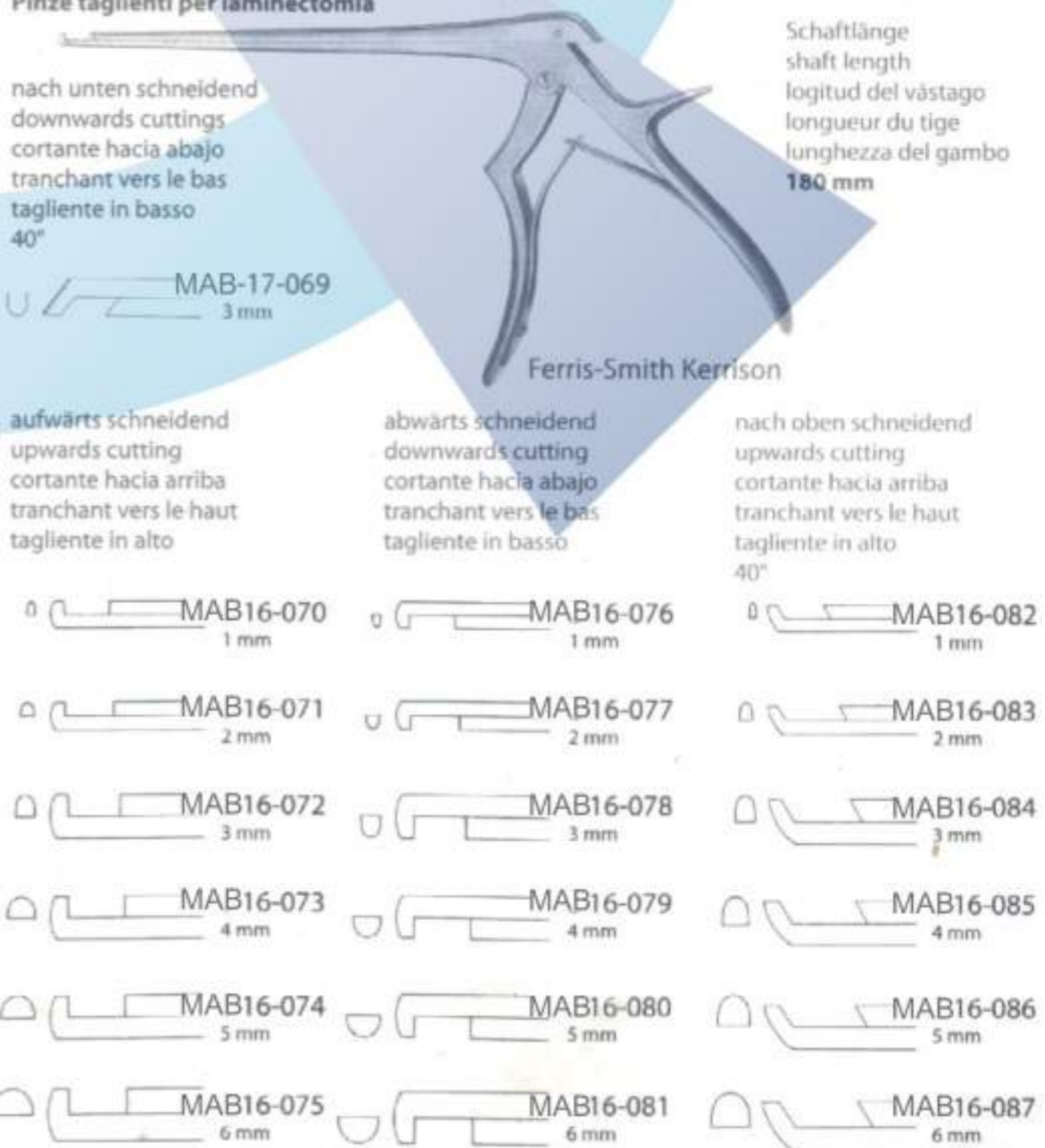



Neurochirurgie, Laminektomie . Neurochirurgie, Laminektomie . Neurochirurgia, Laminectomia  
 Laminektomie zangen  
 Laminectomy Rongeurs  
 Pinzas para laminectomia  
 Pincas pour laminectomie  
 Pinze per laminectomia

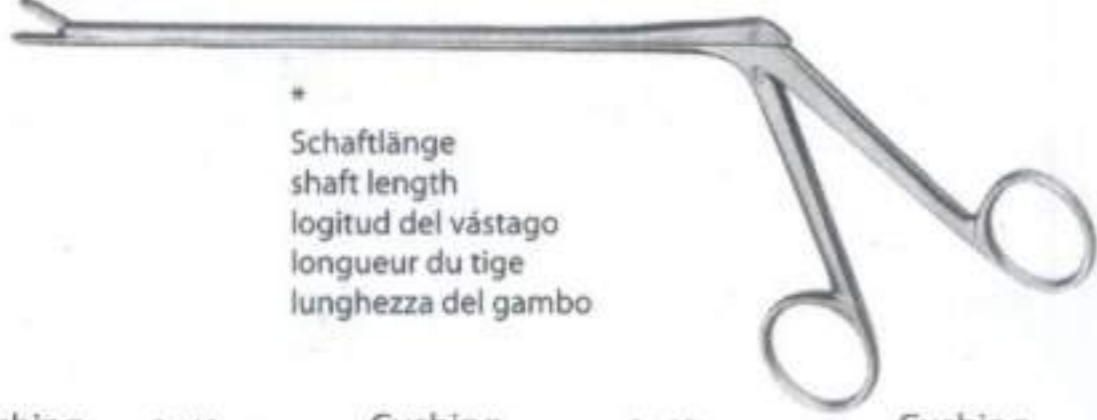

\*  
 Schaftlänge  
 shaft length  
 logitud del vástago  
 longueur du tige  
 lunghezza del gambo

Cushing	2 x 10 mm	Cushing	2 x 10 mm	Cushing	2 x 10 mm
gerade	*	nach oben	*	nach unten	*
straight		upwards		downward	
recta		hacia arriba		hacia abajo	
droite		verse le haut		verse le bas	
diritta		in alto		in basso	
MAB16-088 = 120 mm		MAB16-091 = 120 mm		MAB16-094 = 120 mm	
MAB16-089 = 150 mm		MAB16-092 = 150 mm		MAB16-095 = 150 mm	
MAB16-090 = 180 mm		MAB16-093 = 180 mm		MAB16-096 = 180 mm	
Love-Gruenwald	3 x 10 mm	Love-Gruenwald	3 x 10 mm	Love-Gruenwald	3 x 10 mm
gerade	*	nach oben	*	nach unten	*
straight		upwards		downward	
recta		hacia arriba		hacia abajo	
droite		verse le haut		verse le bas	
diritta		in alto		in basso	
MAB16-097 = 120 mm		MAB16-100 = 120 mm		MAB16-103 = 120 mm	
MAB16-098 = 150 mm		MAB16-101 = 150 mm		MAB16-104 = 150 mm	
MAB16-099 = 180 mm		MAB16-102 = 180 mm		MAB16-105 = 180 mm	
Spurling	4 x 10 mm	Spurling	4 x 10 mm	Spurling	4 x 10 mm
gerade	*	nach oben	*	nach unten	*
straight		upwards		downward	
recta		hacia arriba		hacia abajo	
droite		verse le haut		verse le bas	
diritta		in alto		in basso	
MAB16-106 = 120 mm		MAB16-109 = 120 mm		MAB16-112 = 120 mm	
MAB16-107 = 150 mm		MAB16-110 = 150 mm		MAB16-113 = 150 mm	
MAB16-108 = 180 mm		MAB16-111 = 180 mm		MAB16-114 = 180 mm	

Neurochirurgie, Laminektomie . Neurosurgery, Laminectomy . Neurocirugía, Laminectomia  
 Laminektomie zangen  
 Laminectomy Rongeurs  
 Pinzas para laminectomia  
 Pincas pour laminectomie  
 Pinze per laminectomia



MAB16-115  
 25 cm / 9 3/4"

Schaftlänge  
 shaft length  
 logitud del vástago  
 longueur du tige  
 lunghezza del gambo  
**180 mm**

Oldberg



MAB16-116  
 25.5 cm / 10"

Schaftlänge  
 shaft length  
 logitud del vástago  
 longueur du tige  
 lunghezza del gambo  
**200 mm**

Yasargil



MAB16-117  
 27 cm / 10 3/4"

Schaftlänge  
 shaft length  
 logitud del vástago  
 longueur du tige  
 lunghezza del gambo  
**185 mm**

Landolt

## MAB 17



Tracheotomie  
 Tracheotomy  
 Traqueotomia  
 Tracheotomie  
 Tracheotomia

Tracheotomie . Tracheotomy . Traqueotomia  
 Trachealtrocar, Trachealdilatatore  
 Tracheotomy Trocar, Tracheal Dilators  
 Traqueótomo, Dilatadores traqueales  
 Trocart pour la trachéotomie, Dilatateurs pour la trachéotomie  
 Trequarto per trachiotomia, Dilatatori per tracheotomia



Ueckermann  
 mit Hohlheft  
 with hollow handle  
 con mango hueco  
 avec manche creux  
 con manico vuoto



MAB17-001  
 11.5 cm / 4 1/2"  
 7.5 mm Ø



MAB17-002  
 11.5 cm / 4 1/2"  
 10 mm Ø



Laborde  
 MAB17-003  
 14 cm / 5 1/2"



Trousseau



MAB17-004  
 14.5 cm / 5 3/4"



**Tracheotomie . Trachéotomie . Tracheotomia**  
**Trachealhaken**  
**Tracheal Hooks**  
**Ganchos traqueales**  
**Ecarteurs pour trachéotomie**  
**Uncini tracheali**

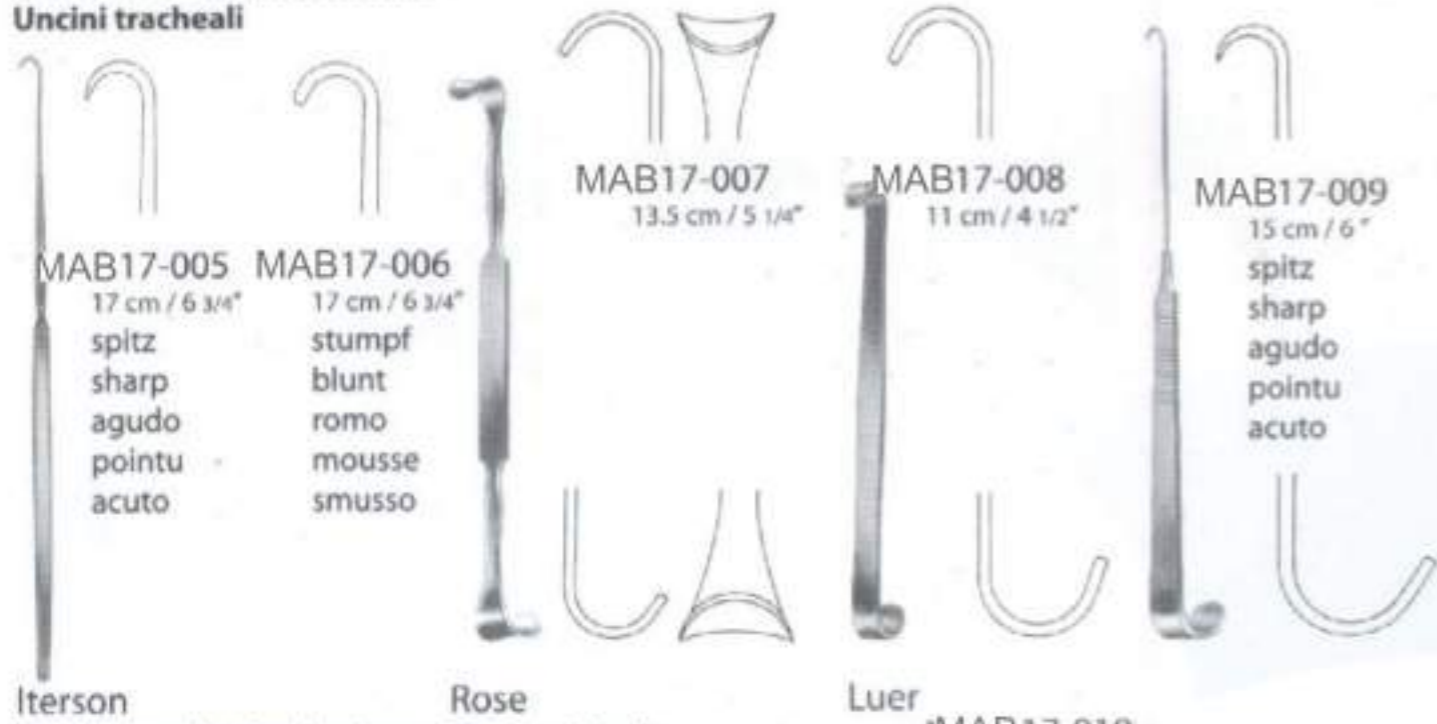

Iterson

Rose

Luer

**Tracheotomie . Tracheotomy . Traqueotomia**  
**Thymushaken, Trachealhaken**  
**Thymus Retractor, Tracheal Hooks**  
**Separador para timo, Ganchos traqueales**  
**Ecarteur pour le thymus, Ecarteurs pour trachéotomie**  
**Divaricatore per il timo, Uncini tracheali**

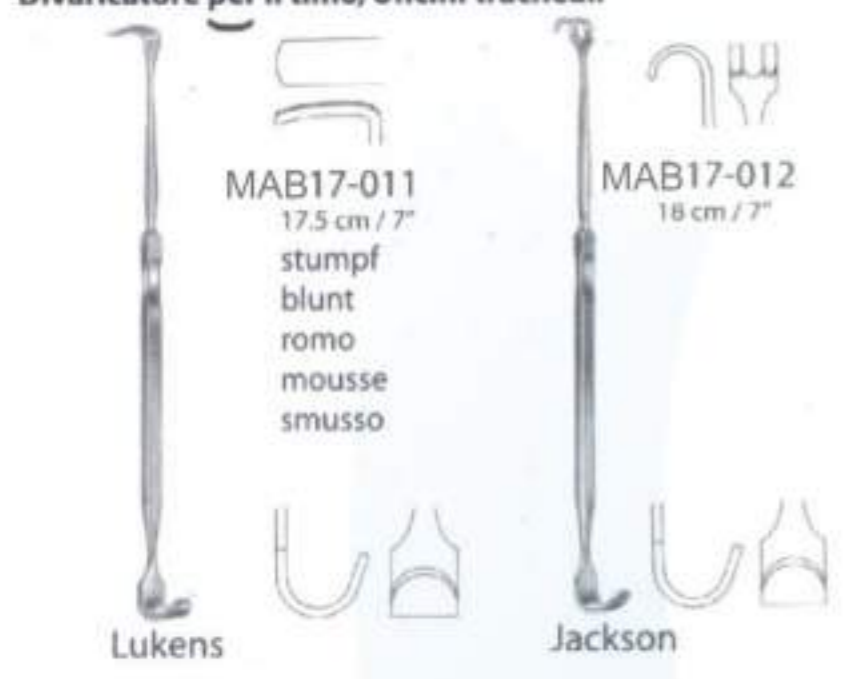

Lukens

Jackson

MAB17-010  
 26 cm / 10 1/4"  
 für Trachealkanülen  
 Bürstenkopf 12 mm Ø  
 for tracheal tubes  
 head of brush 12 mm Ø  
 para cánulas traqueales  
 cabeza del cepillo 12 mm Ø  
 pour canules trachéales  
 tête du brosse 12 mm Ø  
 per cannule tracheali  
 testa di spazzolino 12 mm Ø

Reinigungsbürste  
 Cleaning Brush  
 Cepillo de limpieza  
 Brosse à nettoyer  
 Spazzolino per pulire

**Tracheotomie . Trachéotomie . Tracheotomia**  
**Kropfsonden**  
**Goitre Enucleator**  
**Sondas para bocio**  
**Spatules à goiter**  
**Sonde per gozzo**

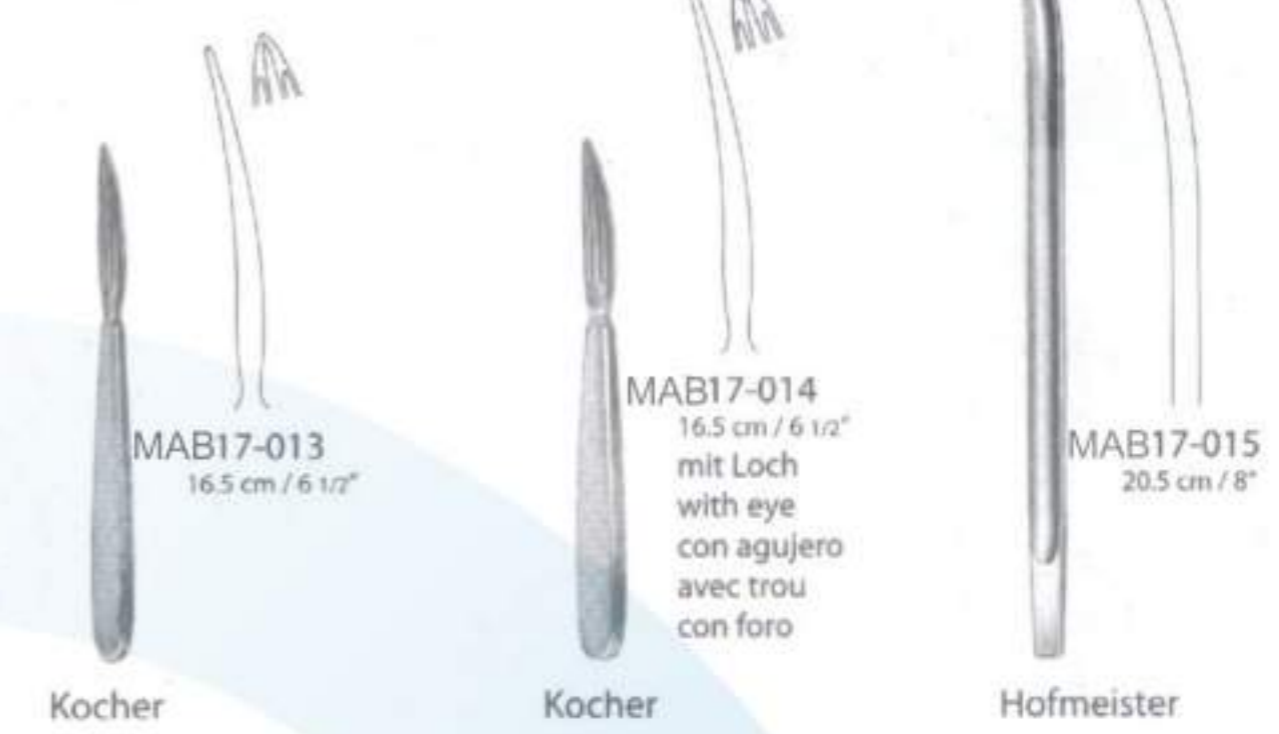

Kocher

Kocher

Hofmeister

**Tracheotomie, Tracheotomy . Traqueotomia**  
**Kropffasszangen**  
**Goitre Grasping Forceps**  
**Pinzas para coger el bocio**  
**Pinces à goitre**  
**Pinze per gozzo**



Lahey

**Tracheotomie . Trachéotomie . Tracheotomia**  
**Trachealkanülen**  
**Tracheal Tubes**  
**Cánulas traqueales**  
**Canules tracheales**  
**Cannule tracheali**

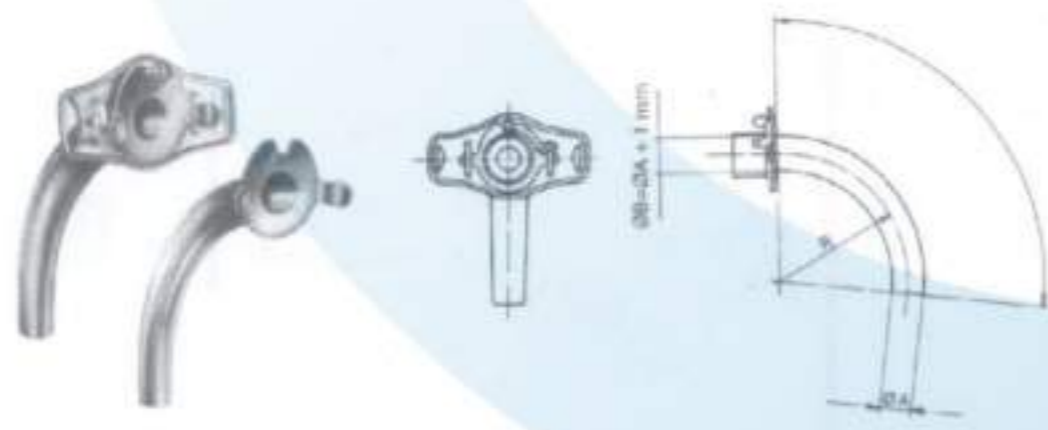

**Tracheotomie . Tracheotomy . Traqueotomia**  
**Trachealkanülen**  
**Tracheal Tubes**  
**Cánulas traqueales**  
**Canules tracheales**  
**Cannule tracheali**

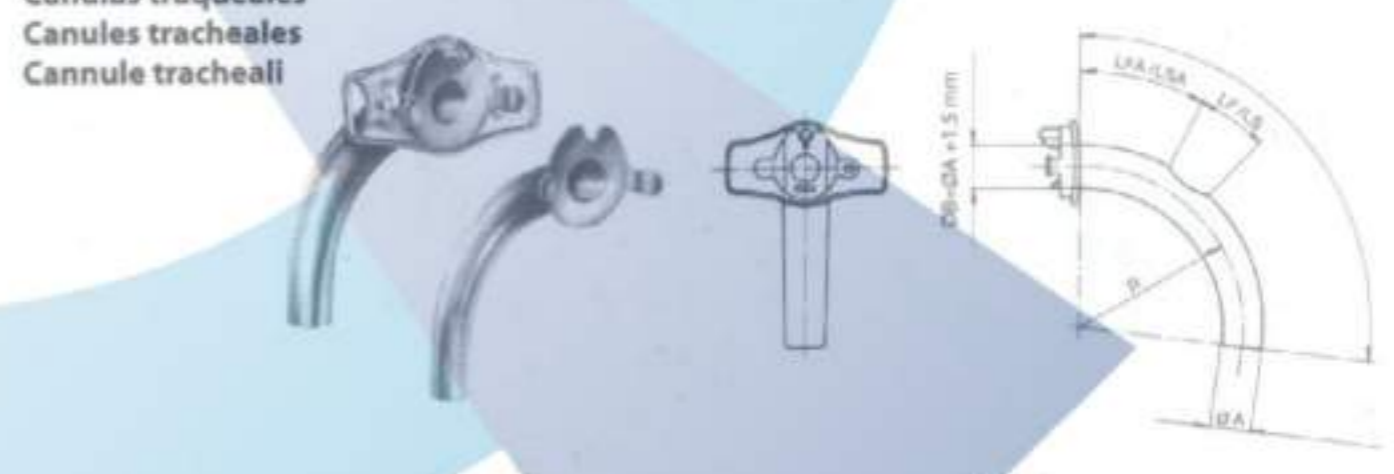

Radius	Fig.	Ø	L	Material	Art.-Nr.
N 0	4 mm	45 mm	MS	MAB17-018	
N 1	5 mm	50 mm	MS	MAB17-019	
N 2	6 mm	55 mm	MS	MAB17-020	
N 3	7 mm	60 mm	MS	MAB17-021	
N 4	8 mm	65 mm	MS	MAB17-022	
N 5	9 mm	70 mm	MS	MAB17-023	
N 6	10 mm	75 mm	MS	MAB17-024	
N 7	11 mm	80 mm	MS	MAB17-025	
N 8	12 mm	85 mm	MS	MAB17-026	
N 9	13 mm	90 mm	MS	MAB17-027	

**Luer**  
 Außenrohr geschlossen  
 Innenrohr geschlossen  
 outer tube closed  
 inner tube closed  
 tubo exterior cerrado  
 tubo interior cerrado  
 canule externe fermée  
 cannule interne fermée  
 cannula esterna chiusa  
 cannula interna chiusa

MS = Silber  
 MS = silver  
 MS = plata  
 MS = argent  
 MS = argento

Radius	Fig.	Ø	L	Material	Art.-Nr.
N 3	7 mm	60 mm	MS	MAB17-028	
N 4	8 mm	65 mm	MS	MAB17-029	
N 5	9 mm	70 mm	MS	MAB17-030	
N 6	10 mm	75 mm	MS	MAB17-031	
N 7	11 mm	80 mm	MS	MAB17-032	
N 8	12 mm	85 mm	MS	MAB17-033	
N 9	13 mm	90 mm	MS	MAB17-034	

**Luer**  
 Außenrohr Fenster  
 Innenrohr Fenster  
 outer tube window  
 inner tube window  
 tubo exterior ventana  
 tubo interior ventana  
 canule externe fenêtre  
 cannule interne fenêtre  
 cannula esterna apertura  
 cannula interna apertura

MS = Silber  
 MS = silver  
 MS = plata  
 MS = argent  
 MS = argento



Tracheotomie, Trachéotomie . Tracheotomia  
Trachealkanülen  
Tracheal Tubes  
Cánulas traqueales  
Canules tracheales  
Cannule tracheali

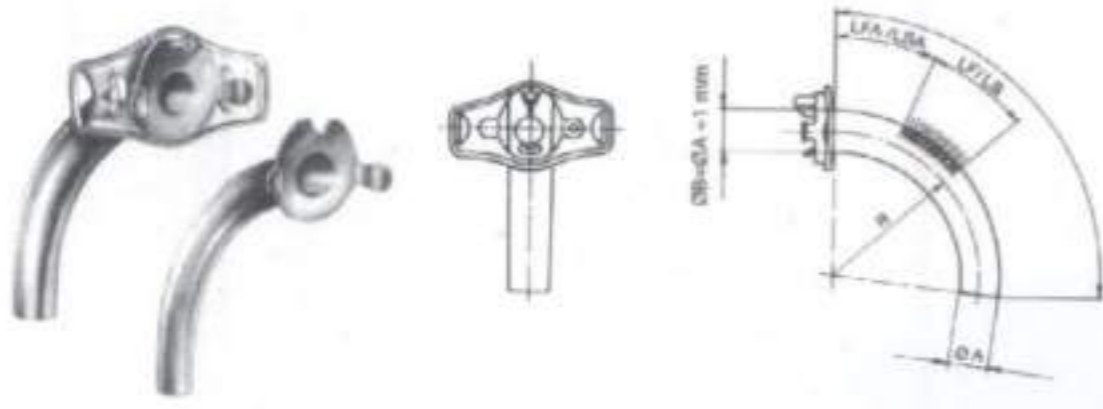

Tracheotomie . Tracheotomy . Traqueotomía  
Trachealkanülen  
Tracheal Tubes  
Cánulas traqueales  
Canules tracheales  
Cannule tracheali

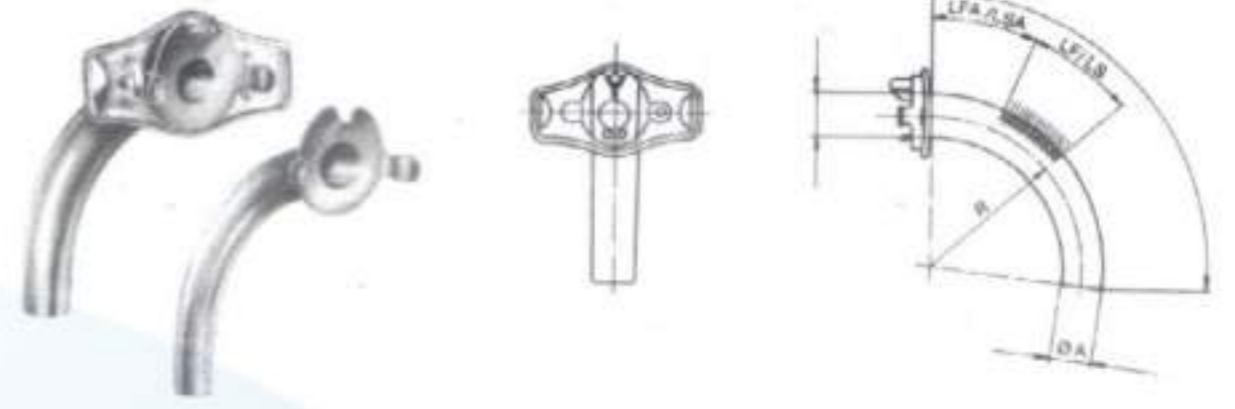

Radius	Fig.	Ø	L	Material	Art.-Nr.
N 3	7 mm	60 mm	MS	MAB17-035	
N 4	8 mm	65 mm	MS	MAB17-036	
N 5	9 mm	70 mm	MS	MAB17-037	
N 6	10 mm	75 mm	MS	MAB17-038	
N 7	11 mm	80 mm	MS	MAB17-039	
N 8	12 mm	85 mm	MS	MAB17-040	
N 9	13 mm	90 mm	MS	MAB17-041	

Luer  
Außenrohr sieb  
Innenrohr Fenster  
outer tube sieve  
inner tube window  
tubo exterior tamiz  
tubo interior ventana  
canule externe tamis  
cannule interne fenetre  
cannula esterna crivello  
cannula interna apertura

MS = Silber  
MS = silver  
MS = plata  
MS = argent  
MS = argento

Radius	Fig.	Ø	L	Material	Art.-Nr.
N 3	7 mm	60 mm	MS	MAB17-042	
N 4	8 mm	65 mm	MS	MAB17-043	
N 5	9 mm	70 mm	MS	MAB17-044	
N 6	10 mm	75 mm	MS	MAB17-045	
N 7	11 mm	80 mm	MS	MAB17-046	
N 8	12 mm	85 mm	MS	MAB17-047	
N 9	13 mm	90 mm	MS	MAB17-048	

Luer  
Außenrohr sieb  
Innenrohr sieb  
outer tube sieve  
inner tube sieve  
tubo exterior tamiz  
tubo interior tamiz  
canule externe tamis  
cannule interne tamis  
cannula esterna crivello  
cannula interna crivello

MS = Silber  
MS = silver  
MS = plata  
MS = argent  
MS = argento

Tracheotomie, Trachéotomie . Tracheotomia  
Trachealkanülen  
Tracheal Tubes  
Cánulas traqueales  
Canules tracheales  
Cannule tracheali

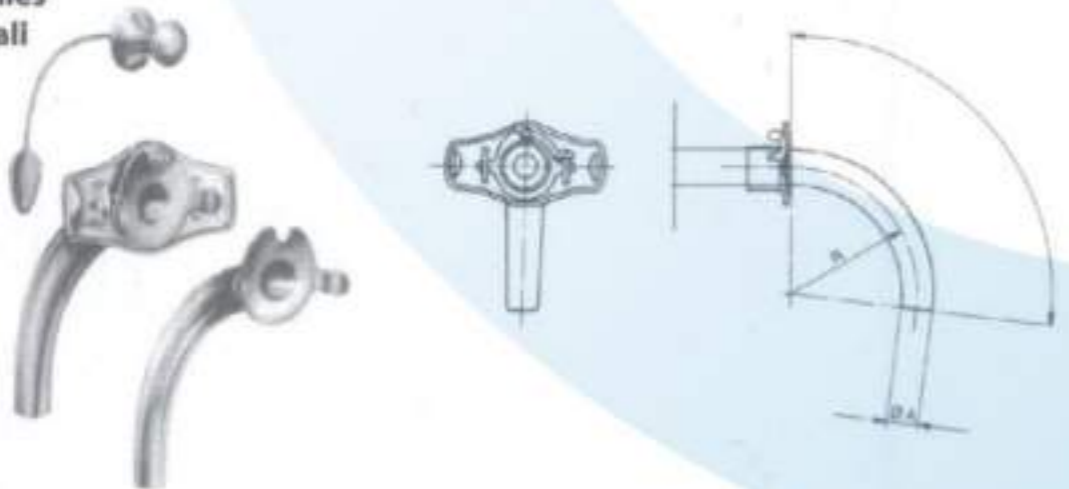

Tracheotomie, Tracheotomy . Traqueotomía  
Trachealkanülen  
Tracheal Tubes  
Cánulas traqueales  
Canules tracheales  
Cannule tracheali

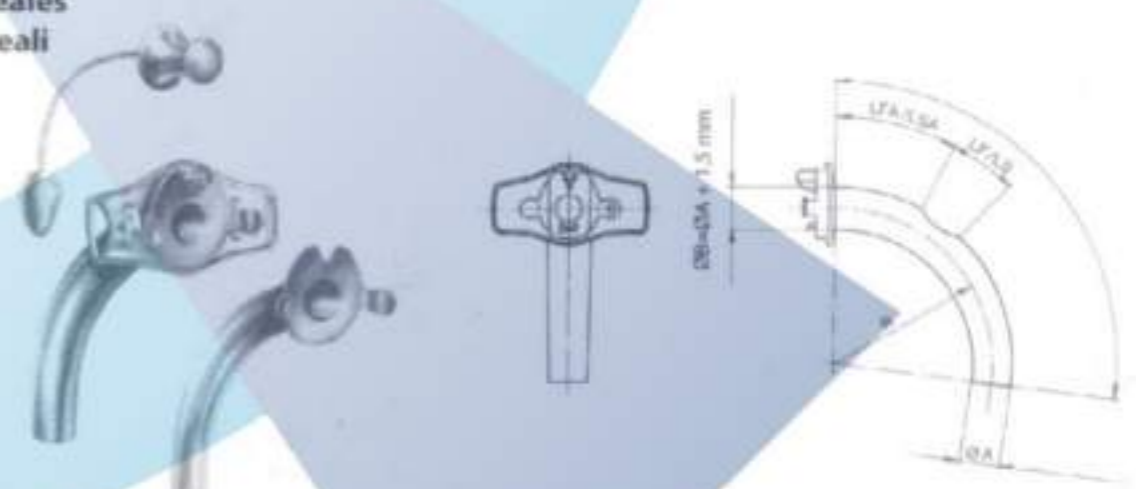

Radius	Fig.	Ø	L	Material	Art.-Nr.
N 0	4 mm	45 mm	MS	MAB17-049	
N 1	5 mm	50 mm	MS	MAB17-050	
N 2	6 mm	55 mm	MS	MAB17-051	
N 3	7 mm	60 mm	MS	MAB17-052	
N 4	8 mm	65 mm	MS	MAB17-053	
N 5	9 mm	70 mm	MS	MAB17-054	
N 6	10 mm	75 mm	MS	MAB17-055	
N 7	11 mm	80 mm	MS	MAB17-056	
N 8	12 mm	85 mm	MS	MAB17-057	
N 9	13 mm	90 mm	MS	MAB17-058	

Chevalier-jackson  
Außenrohr geschlossen  
Innenrohr geschlossen  
puter tube closed  
inner tube closed  
tubo exterior cerrado  
tubo interior cerrado  
canule externe fermée  
cannule interne fermée  
cannula esterna chiusa  
cannula interna chiusa

MS = Silber  
MS = silver  
MS = plata  
MS = argent  
MS = argento

Chevalier-Jackson  
Außenrohr Fenster  
Innenrohr Fenster  
puter tube window  
inner tube window  
tubo exterior ventana  
tubo interior ventana  
canule externe fenetre  
cannule interne fenetre  
cannula esterna apertura  
cannula interna apertura

S 17-031  
MS = Silber  
MS = silver  
MS = plata  
MS = argent  
MS = argento

Radius	Fig.	Ø	L	Material	Art.-Nr.
N 3	7 mm	60 mm	MS	MAB17-059	
N 4	8 mm	65 mm	MS	MAB17-060	
N 5	9 mm	70 mm	MS	MAB17-061	
N 6	10 mm	75 mm	MS	MAB17-062	
N 7	11 mm	80 mm	MS	MAB17-063	
N 8	12 mm	85 mm	MS	MAB17-064	
N 9	13 mm	90 mm	MS	MAB17-065	



**Tracheotomie, Trachéotomie . Tracheotomia**  
**Trachealkanülen**  
**Tracheal Tubes**  
**Cánulas traqueales**  
**Canules tracheales**  
**Cannule tracheali**

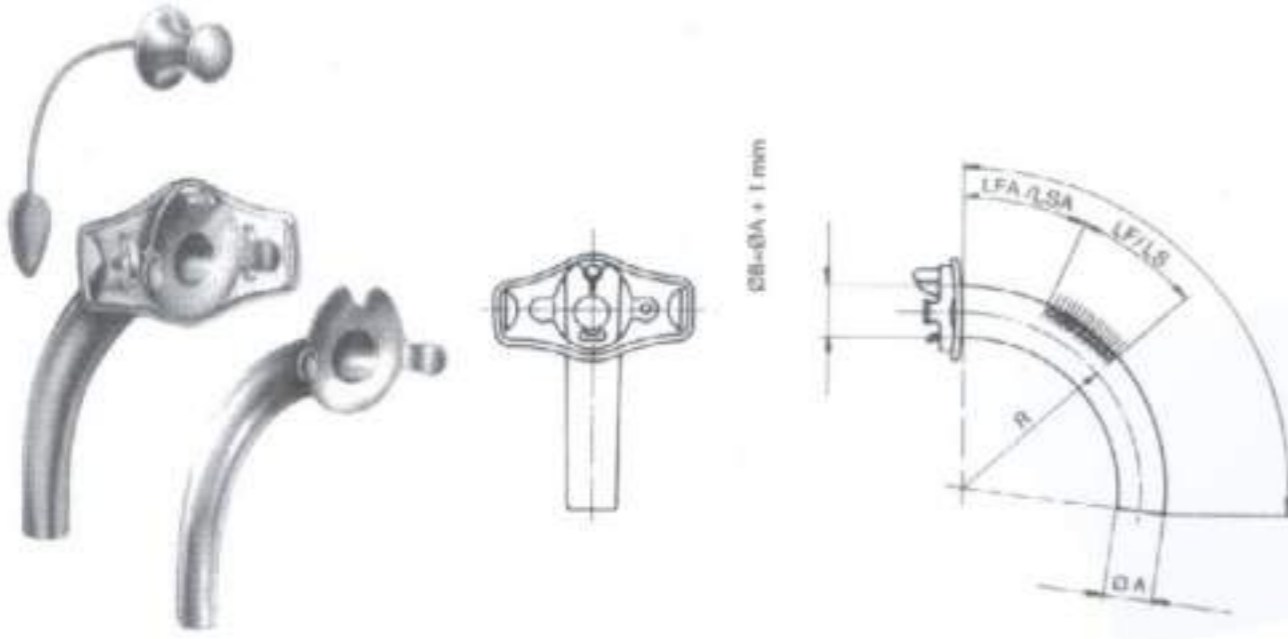

**Tracheotomie, Tracheotomy . Traqueotomía**  
**Trachealkanülen**  
**Tracheal Tubes**  
**Cánulas traqueales**  
**Canules tracheales**  
**Cannule tracheali**

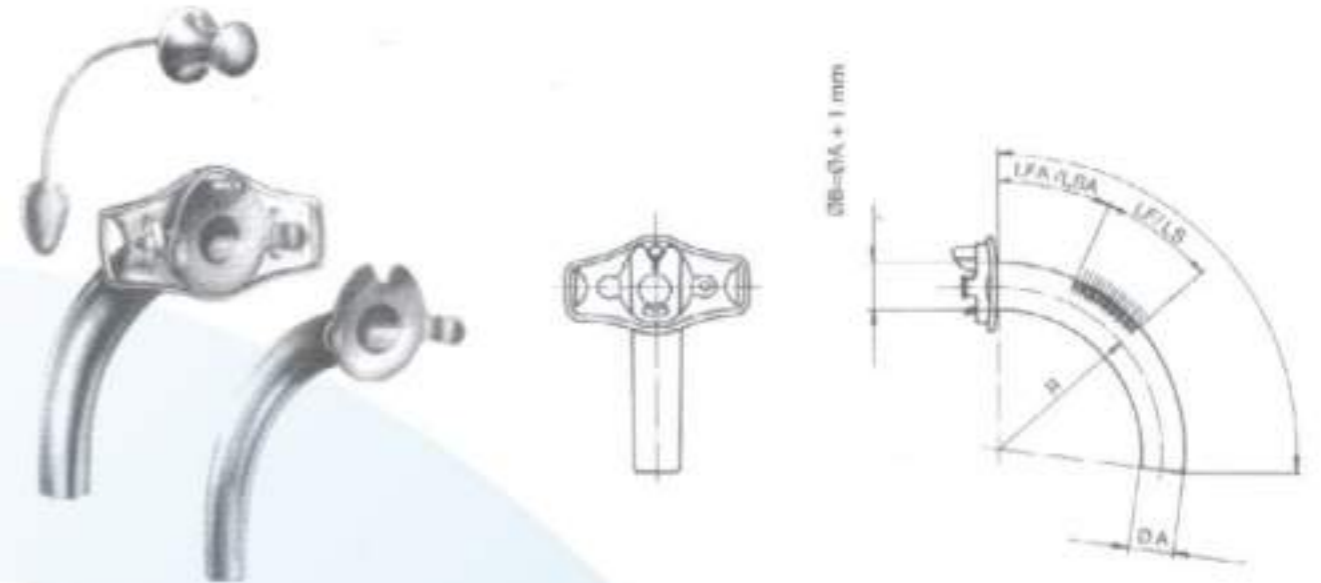

**Chevalier-Jackson**  
**Außenrohr sieb**  
**Innenrohr Fenster**  
**puter tube sieve**  
**inner tube window**  
**tubo exterior tamiz**  
**tubo interior ventana**  
**canule externe tamiz**  
**cannule interne fenetre**  
**cannula esterna crivello**  
**cannula interna apertura**

Radius	Fig.	Ø	L	Material	Art.-Nr.
N 3	7 mm	60 mm	MS	MAB17-066	
N 4	8 mm	65 mm	MS	MAB17-067	
N 5	9 mm	70 mm	MS	MAB17-068	
N 6	10 mm	75 mm	MS	MAB17-069	
N 7	11 mm	80 mm	MS	MAB17-070	
N 8	12 mm	85 mm	MS	MAB17-071	
N 9	13 mm	90 mm	MS	MAB17-072	

MS = Silber  
 MS = silver  
 MS = plata  
 MS = argent  
 MS = argento

**Chevalier-Jackson**  
**Außenrohr sieb**  
**Innenrohr sieb**  
**puter tube sieve**  
**inner tube sieve**  
**tubo exterior tamiz**  
**tubo interior tamiz**  
**canule externe tamiz**  
**cannule interne tamis**  
**cannula esterna crivello**  
**cannula interna crivello**

Radius	Fig.	Ø	L	Material	Art.-Nr.
N 3	7 mm	60 mm	MS	MAB17-073	
N 4	8 mm	65 mm	MS	MAB17-074	
N 5	9 mm	70 mm	MS	MAB17-075	
N 6	10 mm	75 mm	MS	MAB17-076	
N 7	11 mm	80 mm	MS	MAB17-077	
N 8	12 mm	85 mm	MS	MAB17-078	
N 9	13 mm	90 mm	MS	MAB17-079	

MS = Silber  
 MS = silver  
 MS = plata  
 MS = argent  
 MS = argento

**Tracheotomie, Trachéotomie . Tracheotomia**  
**Sprechkanülen**  
**Speaking Tubes**  
**Cánulas parlantes**  
**Canules parlantes**  
**Cannule parlanti**

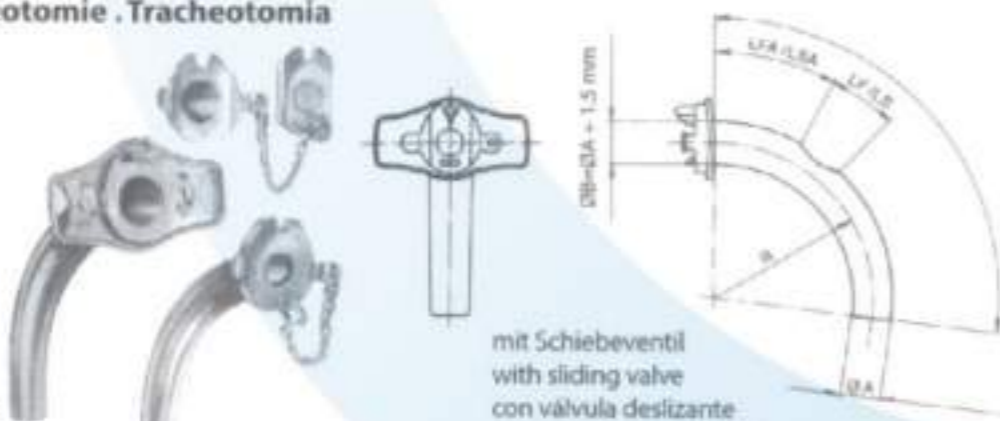

**Außenrohr geschlossen**  
**Innenrohr geschlossen**  
**puter tube closed**  
**inner tube closed**  
**tubo exterior cerrado**  
**tubo interior cerrado**  
**canule externe fermée**  
**cannule interne fermée**  
**cannula esterna chiusa**  
**cannula interna chiusa**

Radius	L	Ø	Material	Art.-Nr.
36.5 mm	65 mm	8 mm	MS	MAB17-080
39.0 mm	70 mm	9 mm	MS	MAB17-081
40.5 mm	75 mm	10 mm	MS	MAB17-082
41.5 mm	80 mm	11 mm	MS	MAB17-083
43.5 mm	85 mm	12 mm	MS	MAB17-084
47.5 mm	90 mm	13 mm	MS	MAB17-085

mit Schiebeventil  
 with sliding valve  
 con válvula deslizante  
 avec soupape à coulisses  
 con valvola a cassetto

**Tracheotomie, Tracheotomy . Traqueotomía**  
**Sprechkanülen**  
**Speaking Tubes**  
**Cánulas parlantes**  
**Canules parlantes**  
**Cannule parlanti**



**Außenrohr Sieb**  
**Innenrohr Fenster**  
**puter tube sieve**  
**inner tube window**  
**tubo exterior tamiz**  
**tubo interior ventana**  
**canule externe tamis**  
**cannule interne fenetre**  
**cannula esterna crivello**  
**cannula interna apertura**

Radius	L	Ø	LSA	LS	Ø / O	LFA	LF	Material	Art.-Nr.
36.5 mm	65 mm	8 mm	15 mm	18 mm	1.7 mm/16	19 mm	12 mm	MAB17-092	
39.0 mm	70 mm	9 mm	18 mm	18 mm	1.8 mm/19	20 mm	13 mm	MAB17-093	
40.5 mm	75 mm	10 mm	20 mm	20 mm	1.8 mm/19	21 mm	13.5 mm	MAB17-094	
41.5 mm	80 mm	11 mm	21 mm	21 mm	2.0 mm/19	22 mm	14 mm	MAB17-095	
43.5 mm	85 mm	12 mm	22 mm	22 mm	2.0 mm/19	23 mm	15 mm	MAB17-096	
47.5 mm	90 mm	13 mm	23 mm	23 mm	2.0 mm/19	24 mm	16 mm	MAB17-097	

mit Schiebeventil  
 with sliding valve  
 con válvula deslizante  
 avec soupape à coulisses  
 con valvola a cassetto

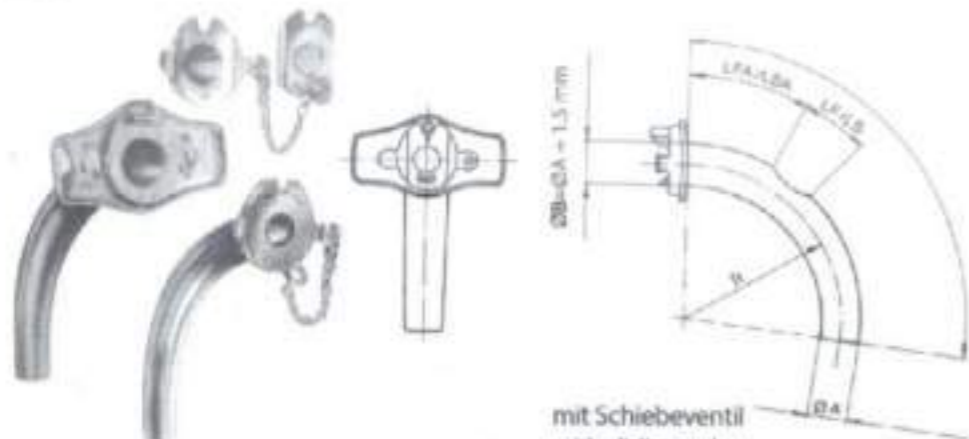

**Außenrohr Fenster**  
**Innenrohr Fenster**  
**puter tube window**  
**inner tube window**  
**tubo exterior ventana**  
**tubo interior ventana**  
**canule externe fenetre**  
**cannule interne fenetre**  
**cannula esterna apertura**  
**cannula interna apertura**

Radius	L	Ø	LFA	LF	Material	Art.-Nr.
36.5 mm	65 mm	8 mm	19 mm	12 mm	MS	MAB17-086
39.0 mm	70 mm	9 mm	20 mm	13 mm	MS	MAB17-087
40.5 mm	75 mm	10 mm	21 mm	13.5 mm	MS	MAB17-088
41.5 mm	80 mm	11 mm	22 mm	14 mm	MS	MAB17-089
43.5 mm	85 mm	12 mm	23 mm	15 mm	MS	MAB17-090
47.5 mm	90 mm	13 mm	24 mm	16 mm	MS	MAB17-091

mit Schiebeventil  
 with sliding valve  
 con válvula deslizante  
 avec soupape à coulisses  
 con valvola a cassetto

**Außenrohr Sieb**  
**Innenrohr Sieb**  
**puter tube sieve**  
**inner tube sieve**  
**tubo exterior tamiz**  
**tubo interior tamiz**  
**canule externe tamis**  
**cannule interne tamis**  
**cannula esterna crivello**  
**cannula interna crivello**

Radius	L	Ø	LSA	LS	Ø / O	Material	Art.-Nr.
36.5 mm	65 mm	8 mm	15 mm	18 mm	1.7 mm/16	MAB S 17-098	
39.0 mm	70 mm	9 mm	18 mm	18 mm	1.8 mm/19	MAB S 17-099	
40.5 mm	75 mm	10 mm	20 mm	20 mm	1.8 mm/19	MAB S 17-100	
41.5 mm	80 mm	11 mm	21 mm	21 mm	2.0 mm/19	MAB S 17-101	
43.5 mm	85 mm	12 mm	22 mm	22 mm	2.0 mm/19	MAB S 17-102	
47.5 mm	90 mm	13 mm	23 mm	23 mm	2.0 mm/19	MAB S 17-103	

mit Schiebeventil  
 with sliding valve  
 con válvula deslizante  
 avec soupape à coulisses  
 con valvola a cassetto

MS = Silber  
 MS = silver  
 MS = plata  
 MS = argent  
 MS = argento

LFA = Distanz Schild bis Fensteranfang  
 LF = Länge Fensteröffnung  
 LSA = Distanz Schild bis Siebanfang  
 LS = Länge des Siebs  
 Ø / o Lochdurchmesser / Anzahl der Locher

LFA = Distance of shield to beginning of window  
 LF = overall length of window  
 LSA = Distance of shield to beginning of sieve  
 LS = length of sieve  
 Ø / o diameter of hole / amount of holes

LFA = Distance de la placa hasta el comienzo de la ventana  
 LF = longitud total de la ventana  
 LSA = Distance de la placa hasta el comienzo del tamiz  
 LS = longitud del tamiz  
 Ø / o diámetro del agujero / cantidad de agujeros



**Dermatologie . Dermatologie . Dermatologia**  
**Face-Lift-Haken, Hauttrephinen**  
**Face-Lift-Hooks, Dermal Punches**  
**Gancho para face-lift, Trépanos para piel**  
**Face-lift Crochet, Trépanos cutanés**  
**Face-lift Uncini, Trefine cutanee**



MAB 18-016  
13 cm / 5"



MAB18-018  
5.5 cm / 2 1/4"  
2 mm Ø

MAB18-020  
5.5 cm / 2 1/4"  
6 mm Ø

MAB18-019  
5.5 cm / 2 1/4"  
4 mm Ø

MAB18-021  
5.5 cm / 2 1/4"  
8 mm Ø

MAB18-022  
5.5 cm / 2 1/4"  
10 mm Ø

MAB18-023  
5.5 cm / 2 1/4"  
12 mm Ø



MAB18-017  
13 cm / 5"

Kaye



MAB18-024  
11 cm / 4 1/2"  
2 mm Ø

MAB18-025  
11 cm / 4 1/3"  
3 mm Ø

MAB18-027  
11 cm / 4 1/3"  
5 mm Ø

Keyes  
11 cm / 4 1/3"

MAB18-029  
11 cm / 4 1/3"  
7 mm Ø

MAB18-026  
11 cm / 4 1/3"  
4 mm Ø

MAB18-028  
11 cm / 4 1/3"  
6 mm Ø

MAB18-030  
11 cm / 4 1/3"  
8 mm Ø



MAB18-031  
8 cm / 3 1/4"

Griff  
Handle  
Mango  
Manche  
Manico

**Dermatologie . Dermatology . Dermatologia**  
**Komedoneninstrumente**  
**Comedone Extractors**  
**Extractores para comedones**  
**Tire-comédons**  
**Tiracomedoni**



MAB18-032  
14.5 cm / 5 3/4"

Unna



MAB18-033  
14.5 cm / 5 3/4"

Unna



MAB18-034  
11 cm / 4 1/3"

Saalfeld



MAB18-035  
14.5 cm / 5 3/4"

Saalfeld



MAB18-036  
9.5 cm / 3 3/4"

Schamberg



MAB 18-037  
16 cm / 6 1/4"

Katsch



MAB18-038  
11.5 cm / 4 1/2"

Unna-Vidal

**Dermatologie . Dermatologie . Dermatologia**  
**Face-Lift-Klemme**  
**Face-lift Forceps**  
**Pinza para Face-lift**  
**Pinces pour Face-lift**  
**Pinze per Face-lift**



MAB18-039  
18 cm / 7"

d'Assumpção

**Dermatologie . Dermatologie . Dermatologia**  
**Face-Lift-Scheren**  
**Face-lift Scissors**  
**Tijeras para Face-lift**  
**Ciseaux pour Face-lift**  
**Forbici per Face-lift**

**Dermatologie . Dermatology . Dermatologia**  
**Face-Lift-Scheren**  
**Face-lift Scissors**  
**Tijeras para Face-lift**  
**Ciseaux pour Face-lift**  
**Forbici Face-lift**



MAB18-040  
14 cm / 5 1/2"

Gregory



MAB18-041  
15 cm / 6"

Kaye

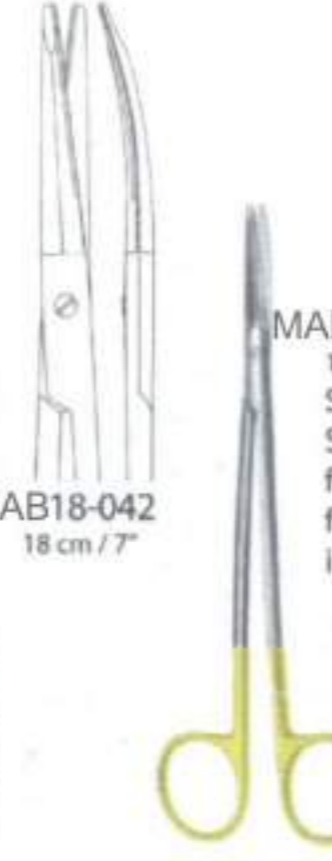

MAB18-042  
18 cm / 7"

Stella-S



MAB18-043  
18 cm / 7"  
S-förmig gebogen  
S-shaped  
forma S  
forme S  
in forma a S

gezahnt  
toothed  
dentada  
dentelés  
dentata



MAB18-044  
18 cm / 7"

Gorney  
gezahnt  
toothed  
dentada  
dentelés  
dentata



MAB18-045  
18 cm / 7"

Freeman-Kaye  
gezahnt  
toothed  
dentada  
dentelés  
dentata



MAB18-046  
23 cm / 9"

Freeman  
gezahnt  
toothed  
dentada  
dentelés  
dentata



**Tracheotomie, Trachéotomie . Traqueotomia**  
**Sprechkanülen**  
**Speaking Tubes**  
**Cánulas parlantes**  
**Canules parlantes**  
**Cannule parlanti**

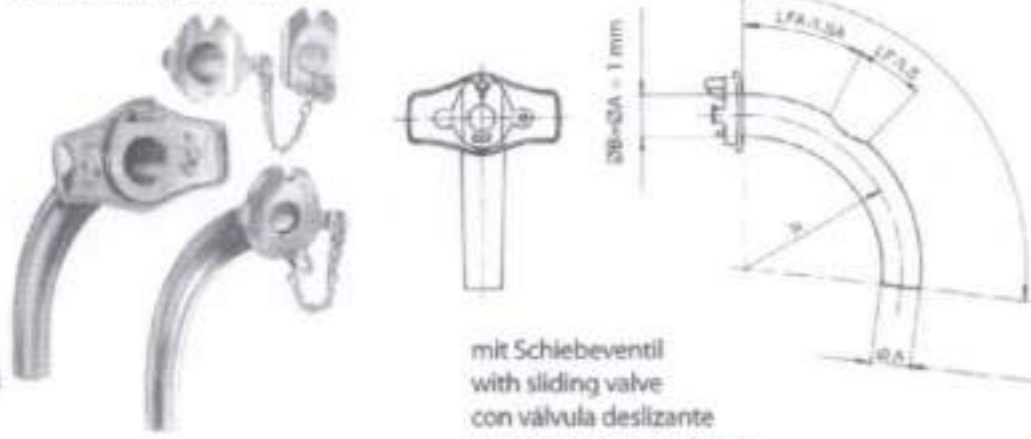

Außenrohr geschlossen  
 Innenrohr geschlossen  
 puter tube closed  
 inner tube closed  
 tubo exterior cerrado  
 tubo interior cerrado  
 canule externe fermée  
 cannule interne fermée  
 cannula esterna chiusa  
 cannula interna chiusa

Radius	L	Ø
36.5 mm	65 mm	8 mm
39.0 mm	70 mm	9 mm
40.5 mm	75 mm	10 mm
41.5 mm	80 mm	11 mm
43.5 mm	85 mm	12 mm
47.5 mm	90 mm	13 mm

mit Schiebeventil  
 with sliding valve  
 con válvula deslizante  
 avec soupape à coulisses  
 con valvola a cassetto

Material	Art.-Nr.
MS	MAB17-104
MS	MAB17-105
MS	MAB17-106
MS	MAB17-107
MS	MAB17-108
MS	MAB17-109

**Tracheotomie, Tracheotomy . Traqueotomia**  
**Sprechkanülen**  
**Speaking Tubes**  
**Cánulas parlantes**  
**Canules parlantes**  
**Cannule parlanti**

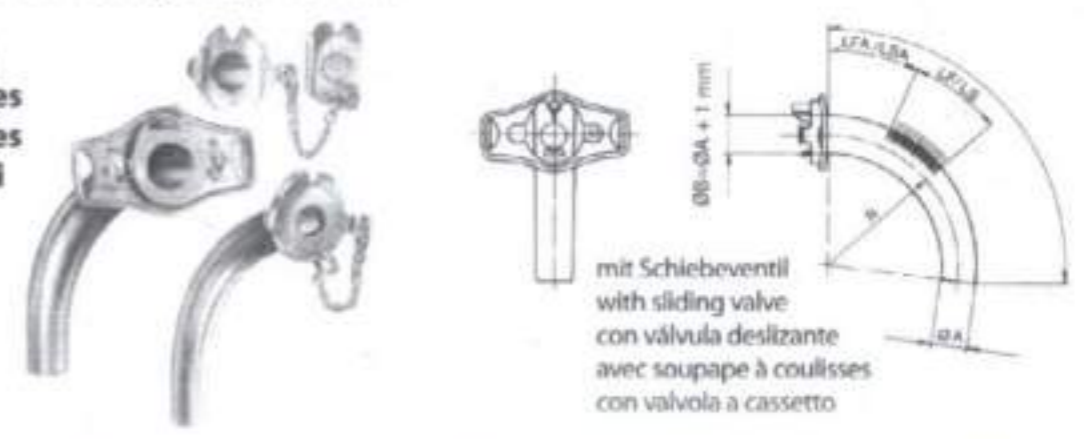

Außenrohr Sieb  
 Innenrohr Fenster  
 puter tube sieve  
 inner tube window  
 tubo exterior tamiz  
 tubo interior ventana  
 canule externe tamis  
 cannule interne fenêtre  
 cannula esterna crivello  
 cannula interna apertura

Radius	L	Ø	LSA	LS	Ø/O	LFA	LF	Material	Art.-Nr.
36.5 mm	65 mm	8 mm	15 mm	18 mm	1.7 mm/16	19 mm	12 mm	MAB17-116	MAB17-116
39.0 mm	70 mm	9 mm	18 mm	18 mm	1.8 mm/19	20 mm	13 mm	MAB17-117	MAB17-117
40.5 mm	75 mm	10 mm	20 mm	20 mm	1.8 mm/19	21 mm	13.5 mm	MAB17-118	MAB17-118
41.5 mm	80 mm	11 mm	21 mm	21 mm	2.0 mm/19	22 mm	14 mm	MAB17-119	MAB17-119
43.5 mm	85 mm	12 mm	22 mm	22 mm	2.0 mm/19	23 mm	15 mm	MAB17-120	MAB17-120
47.5 mm	90 mm	13 mm	23 mm	23 mm	2.0 mm/19	24 mm	16 mm	MAB17-121	MAB17-121

mit Schiebeventil  
 with sliding valve  
 con válvula deslizante  
 avec soupape à coulisses  
 con valvola a cassetto

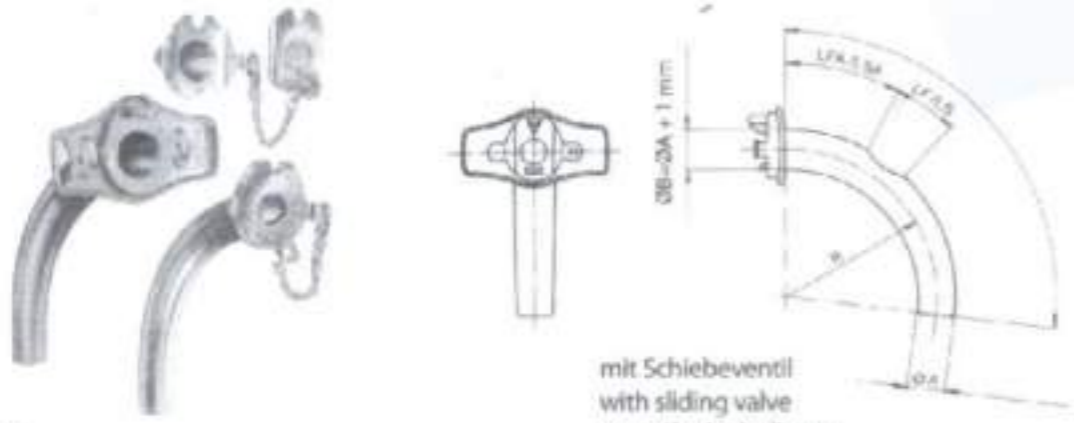

Außenrohr Fenster  
 Innenrohr Fenster  
 puter tube window  
 inner tube window  
 tubo exterior ventana  
 tubo interior ventana  
 canule externe fenêtre  
 cannule interne fenètre  
 cannula esterna apertura  
 cannula interna apertura

Radius	L	Ø	LFA	LF	Material	Art.-Nr.
36.5 mm	65 mm	8 mm	19 mm	12 mm	MS	MAB17-110
39.0 mm	70 mm	9 mm	20 mm	13 mm	MS	MAB17-111
40.5 mm	75 mm	10 mm	21 mm	13.5 mm	MS	MAB17-112
41.5 mm	80 mm	11 mm	22 mm	14 mm	MS	MAB17-113
43.5 mm	85 mm	12 mm	23 mm	15 mm	MS	MAB17-114
47.5 mm	90 mm	13 mm	24 mm	16 mm	MS	MAB17-115

mit Schiebeventil  
 with sliding valve  
 con válvula deslizante  
 avec soupape à coulisses  
 con valvola a cassetto

Außenrohr Sieb  
 Innenrohr Sieb  
 puter tube sieve  
 inner tube sieve  
 tubo exterior tamiz  
 tubo interior tamiz  
 canule externe tamis  
 cannule interne tamis  
 cannula esterna crivello  
 cannula interna crivello

Radius	L	Ø	LSA	LS	Ø/O	Material	Art.-Nr.
36.5 mm	65 mm	8 mm	15 mm	18 mm	1.7 mm/16	MAB17-122	MAB17-122
39.0 mm	70 mm	9 mm	18 mm	18 mm	1.8 mm/19	MAB17-123	MAB17-123
40.5 mm	75 mm	10 mm	20 mm	20 mm	1.8 mm/19	MAB17-124	MAB17-124
41.5 mm	80 mm	11 mm	21 mm	21 mm	2.0 mm/19	MAB17-125	MAB17-125
43.5 mm	85 mm	12 mm	22 mm	22 mm	2.0 mm/19	MAB17-126	MAB17-126
47.5 mm	90 mm	13 mm	23 mm	23 mm	2.0 mm/19	MAB17-127	MAB17-127

mit Schiebeventil  
 with sliding valve  
 con válvula deslizante  
 avec soupape à coulisses  
 con valvola a cassetto

MS = Silber  
 MS = silver

MS = plata  
 MS = argent

MS = argento

**Dermatologie . Dermatology . Dermatología**  
**Lupusküretten, Hauthäkchen**  
**Lupus Currettes, Skin Hooklets**  
**Curetas para lupus, Ganchitos para piel**  
**Curettes pour les lupus, Erignes cutanées**  
**Curette per lupus, Uncini cutanei**

## MAB 18

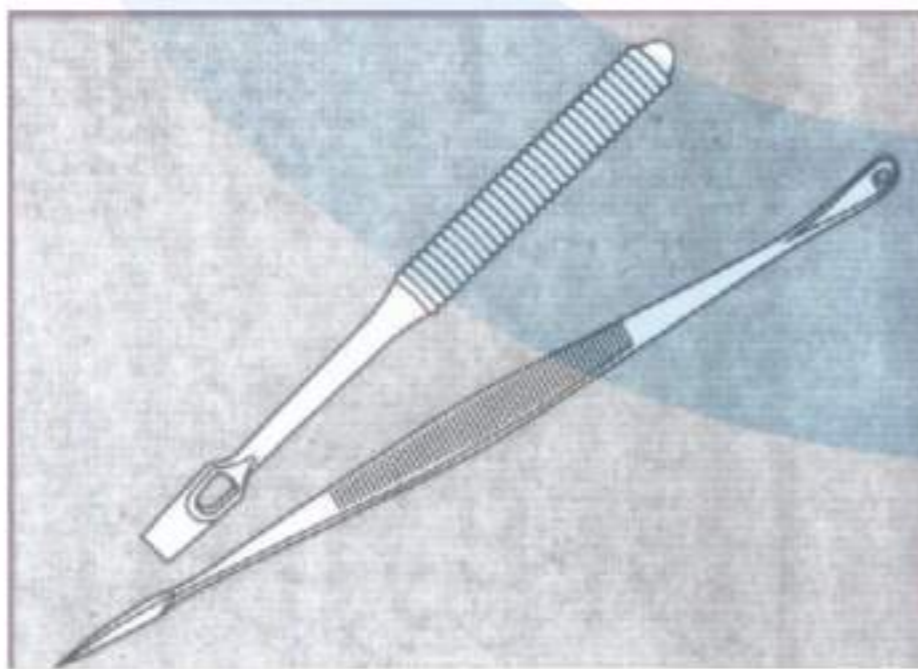

**Dermatologie**  
**Dermatology**  
**Dermatologia**  
**Dermatologie**  
**Dermatologia**

<p>MAB18-001 14 cm / 5 1/2" Millenmesser Millium Knife Chuchillo para millium Couteau pour millium Bisturi per mille</p> <p>Moncorps</p>	<p>Ersatzklinge Spare Blade Hoja de repuesto Lame de rechange Lame di ricambio</p>	<p>MAB18-002 13 cm / 5" Lupusschaber Lupus Scraper Rascador para lupus Rugine pour les lupus Raschiatoio per lupus</p> <p>Vidal</p>	<p>MAB18-003 Fig.1</p> <p>MAB18-004 Fig.2</p> <p>MAB18-005 Fig.3</p> <p>MAB18-006 Fig.4</p> <p>Fox 14 cm / 5 1/2"</p>
<p>MAB18-007 Fig.1</p> <p>MAB18-008 Fig.3</p> <p>MAB18-009 Fig.5</p> <p>Wolff 14 cm / 5 1/2"</p>	<p>MAB18-010 Fig.2</p> <p>MAB18-011 Fig.4</p> <p>MAB18-012 Fig.6</p>	<p>MAB18-013 14.5 cm / 5 3/4" Kilner scharf sharp agudo aigué aguzzo</p>	<p>MAB18-014 18 cm / 7" Fig.1 Kleine Biegung small curvature curva pequeña courbure petite curva piccola</p> <p>MAB18-015 18 cm / 7" Fig.2 große Biegung large curvature curva larga courbure grande curva grande</p>



## MAB 19



Magen, Darm, Rektum  
 Stomach, Intestines, Rectum  
 Estomago, Intestinos, Recto  
 Estomac, Intestins, Rectum  
 Stomaco, Intesini, Retto

Magen, Darm, Rektum . Stomach, Intestines, Rectum . Estómago. Intestinos, Recto  
 Darm- und Gewebefasszangen  
 Intestinal and Tissue Grasping Forceps  
 Pinzas para intestinos y tejidos  
 Pinces pour saisir intestins et tissus  
 Pinze per afferrare intestino e tessuti



Magen, Darm, Rektum . Estomac, Intestins, Rectum . Stomaco. Intestini, Retto  
 Darm- und Gewebefasszangen  
 Intestinal and Tissue Grasping Forceps  
 Pinzas para intestinos y tejidos  
 Pinces pour saisir intestins et tissus  
 Pinze per afferrare intestino e tessuti

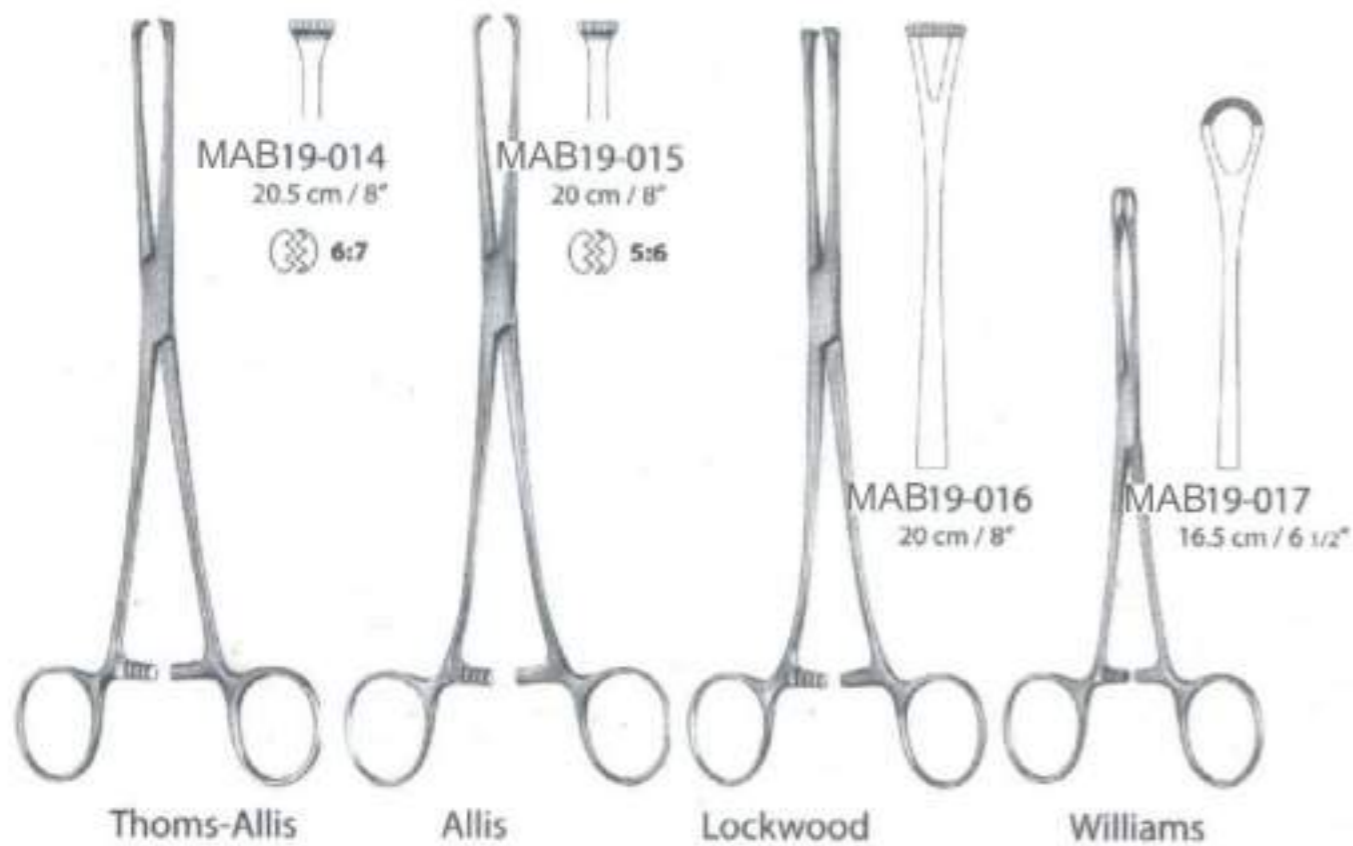

Magen, Darm, Rektum . Stomach, Intestines, Rectum . Estómago. Intestinos, Recto  
 Darm- und Gewebefasszangen  
 Intestinal and Tissue Grasping Forceps  
 Pinzas para intestinos y tejidos  
 Pinces pour saisir intestins et tissus  
 Pinze per afferrare intestino e tessuti





Magen, Darm, Rektum . Estomac, Intestins, Rectum . Stomaco, Intestini, Retto  
 Darm- und Gewebefassungen  
 Intestinal and Tissue Grasping Forceps  
 Pinzas para intestinos y tejidos  
 Pincers pour saisir intestins et tissus  
 Pinze per afferrare intestino e tessuti



Magen, Darm, Rektum . Stomach, Intestines, Rectum . Estómago, Intestinos, Recto  
 Darmklemmen  
 Intestinal Clamps  
 Pinzas intestinales  
 Pincers intestinales  
 Pinze intestinali

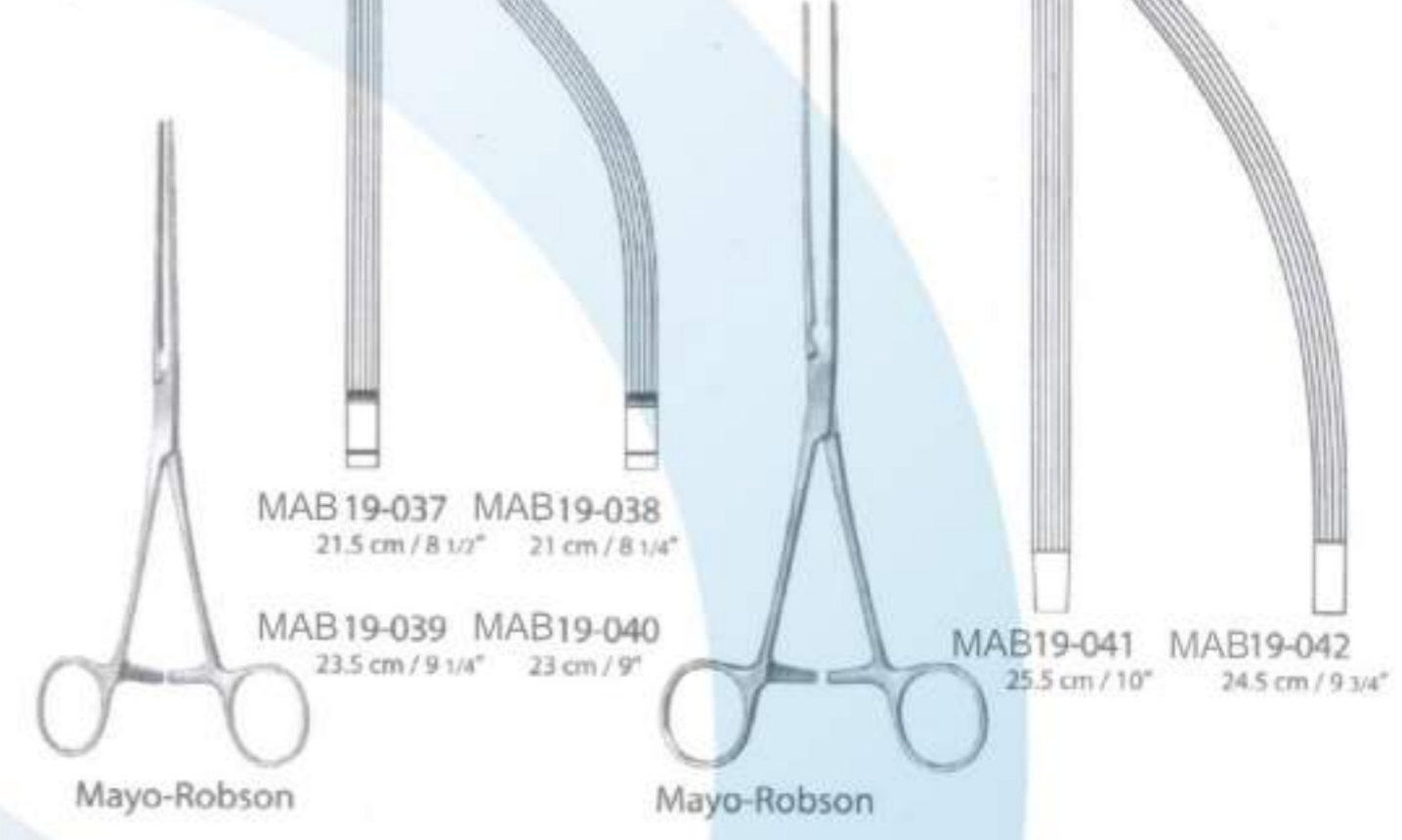
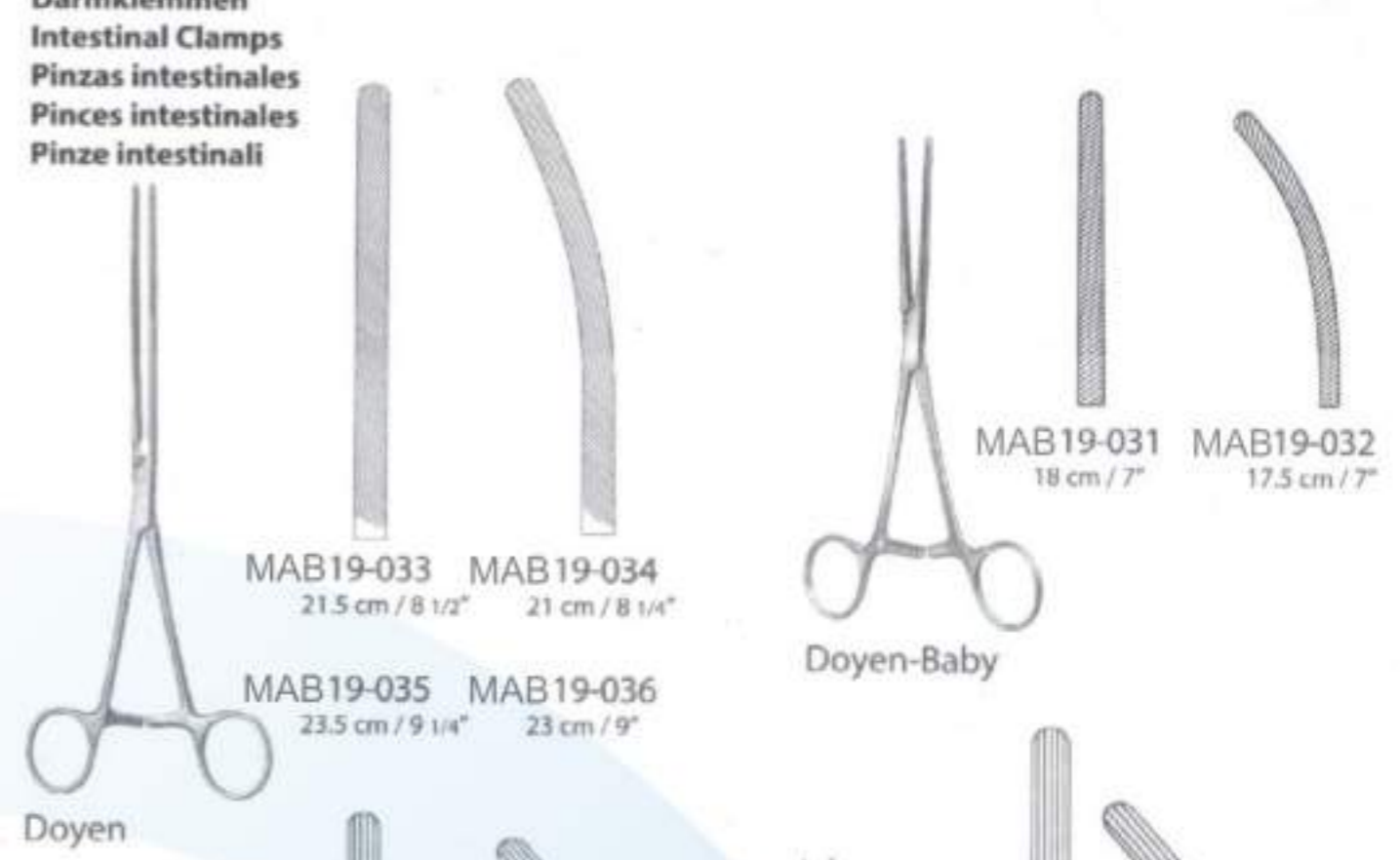

Magen, Darm, Rektum . Stomach, Intestines, Rectum . Estómago, Intestinos, Recto  
 Darmklemmen  
 Intestinal Clamps  
 Pinzas intestinales  
 Pincers intestinales  
 Pinze intestinali



Magen, Darm, Rektum . Stomach, Intestines, Rectum . Estómago, Intestinos, Recto  
 Darmquetschklemmen  
 Intestinal and Pylorus Clamps  
 Pinzas intestinales para piloro  
 Ecraseurs pour intestin  
 Schiacciatori intestinali



Magen, Darm, Rektum . Estomac, Intestins, Rectum . Stomaco, Intestini, Retto  
 Darm-Anastomosenklemmen  
 Intestinal Anastomosis Clamps  
 Clamps para anastomosis intestinales  
 Pincers-clamps pour anastomose intestinale  
 Pinze per anastomosi intestinali





Magen, Darm, Rektum . Stomach, Intestines, Rectum . Estómago, Intestinos, Recto  
 Darm-Anastomosenklammern  
 Intestinal Anastomosis Clamps  
 Clamps para anastomosis intestinales  
 Clamps pour anastomoses intestinales  
 Pinze per anastomosi intestinali

Magen, Darm, Rektum . Stomach, Intestines, Rectum . Estómago, Intestinos, Recto  
 Organfaßzangen  
 Organ Grasping forceps  
 Pinzas para coger órganos  
 Pinces pour saisir des organes  
 Pinze per afferrare organi

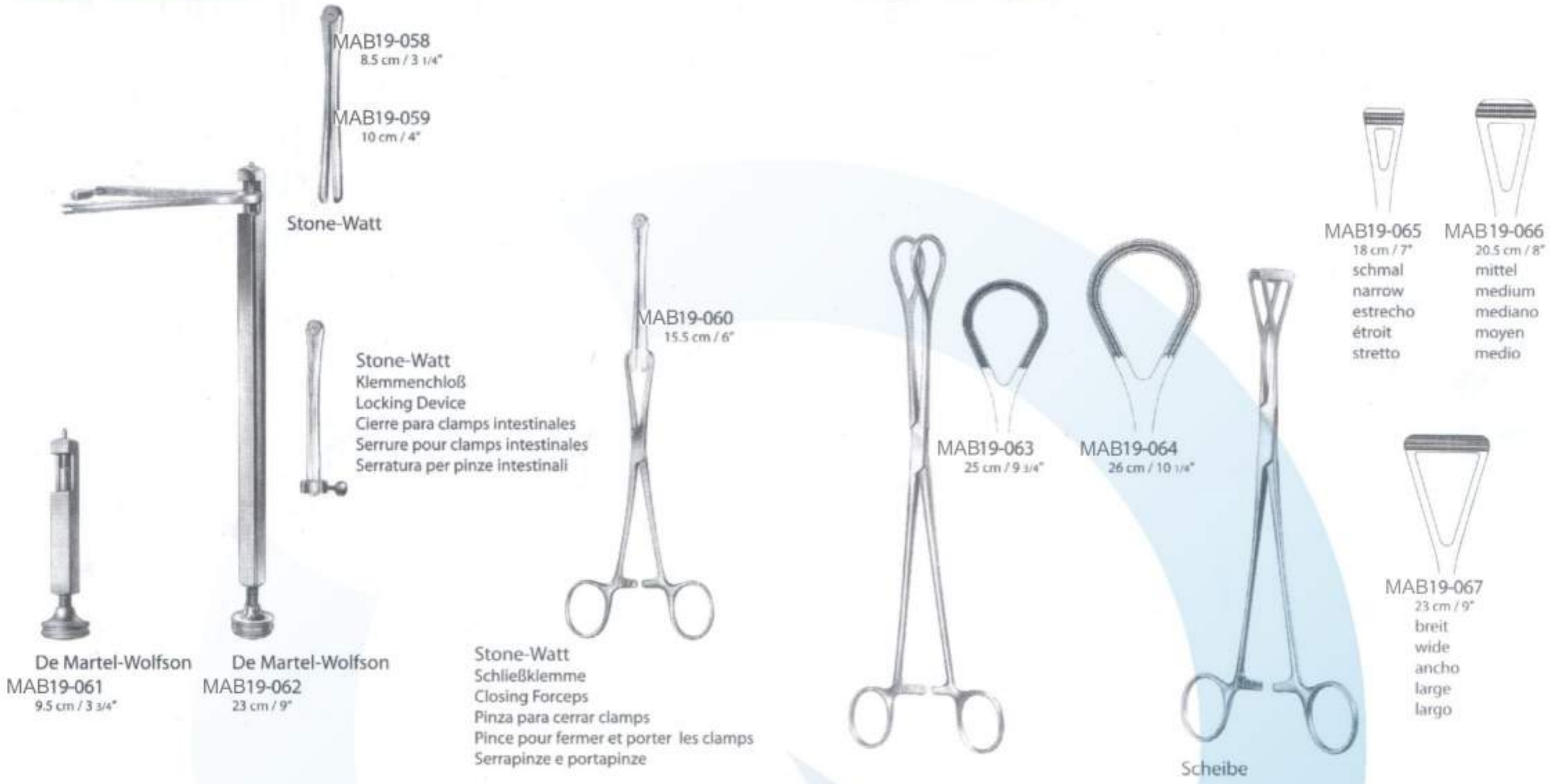

Magen, Darm, Rektum . Estomac, Intestins, Rectum . Stomaco, Intestini, Retto  
 Darmklammern  
 Intestinal Clamps  
 Pinzas intestinales  
 Pinces intestinales  
 Pinze intestinali

Magen, Darm, Rektum . Stomach, Intestines, Rectum . Estómago, Intestinos, Recto  
 Darmklammern  
 Intestinal Clamps  
 Pinzas intestinales  
 Pinces intestinales  
 Pinze intestinali

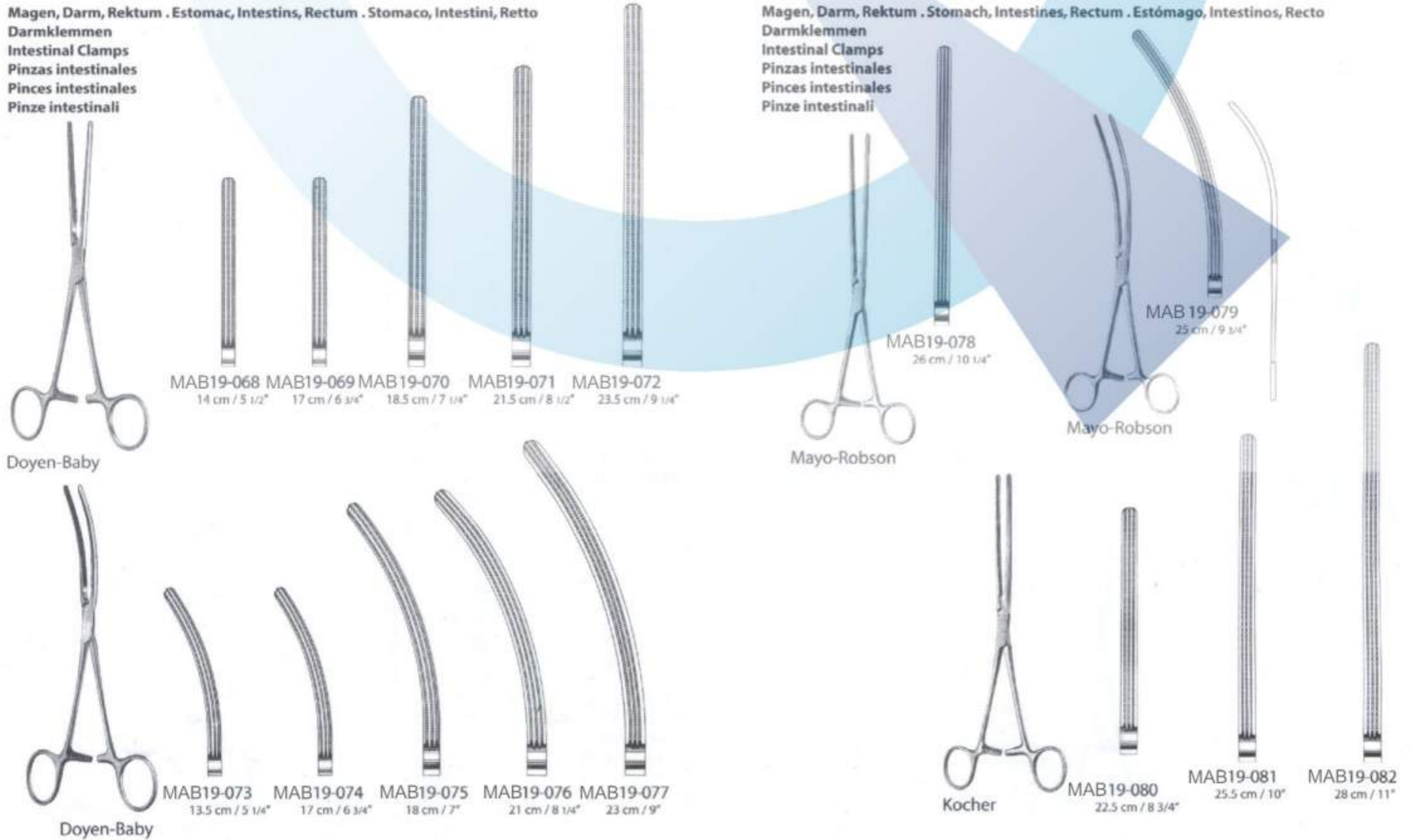



Magen, Darm, Rektum . Stomach, Intestines, Rectum . Estómago, Intestinos, Recto  
 Darmklemmen  
 Intestinal Clamps  
 Pinzas intestinales  
 Pincas intestinales  
 Pinze intestinali

Magen, Darm, Rektum . Estomac, Intestins, Rectum . Stomaco, Intestini, Retto  
 Darmklemmen, Rektum-Anastomosenklemmen  
 Intestinal Clamps, Sigmoid Anastomosis Forceps  
 Pinzas intestinales, Pinzas para anastomosis rectales  
 Pincas intestinales, Pincas pour anastomoses rectales  
 Pinze intestinali, Pinze per anastomosi rettali



Magen, Darm, Rektum . Stomach, Intestines, Rectum . Estómago, Intestinos, Recto  
 Rektum-Anastomosenklemmen  
 Sigmoid Anastomosis Forceps  
 Pinzas para anastomosis rectales  
 Pincas pour anastomoses rectales  
 Pinze per anastomosi rettali

Magen, Darm, Rektum . Stomach, Intestines, Rectum . Estómago, Intestinos, Recto  
 Rektum-Anastomosenklemmen  
 Sigmoid Anastomosis Forceps  
 Pinzas para anastomosis rectales  
 Pincas pour anastomoses rectales  
 Pinze per anastomosi rettali

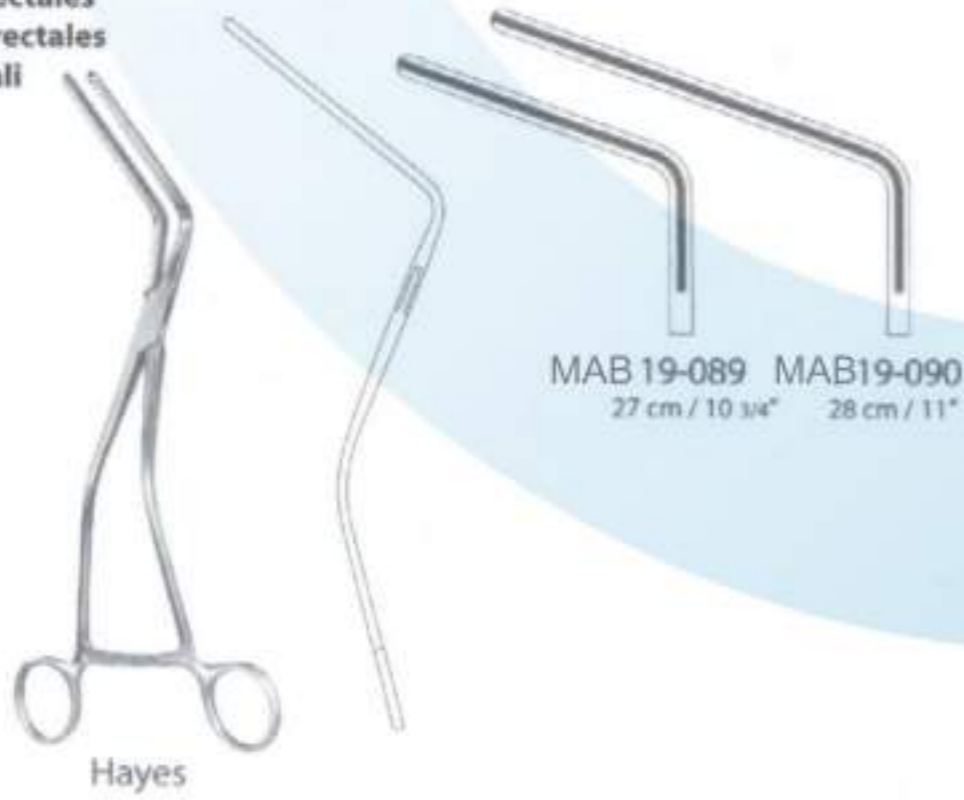

Magen, Darm, Rektum . Estomac, Intestins, Rectum . Stomaco, Intestini, Retto  
 Mastdarmspekula  
 Rectal Specula  
 Espéculos rectales  
 Spéculum rectaux  
 Specoli rettali

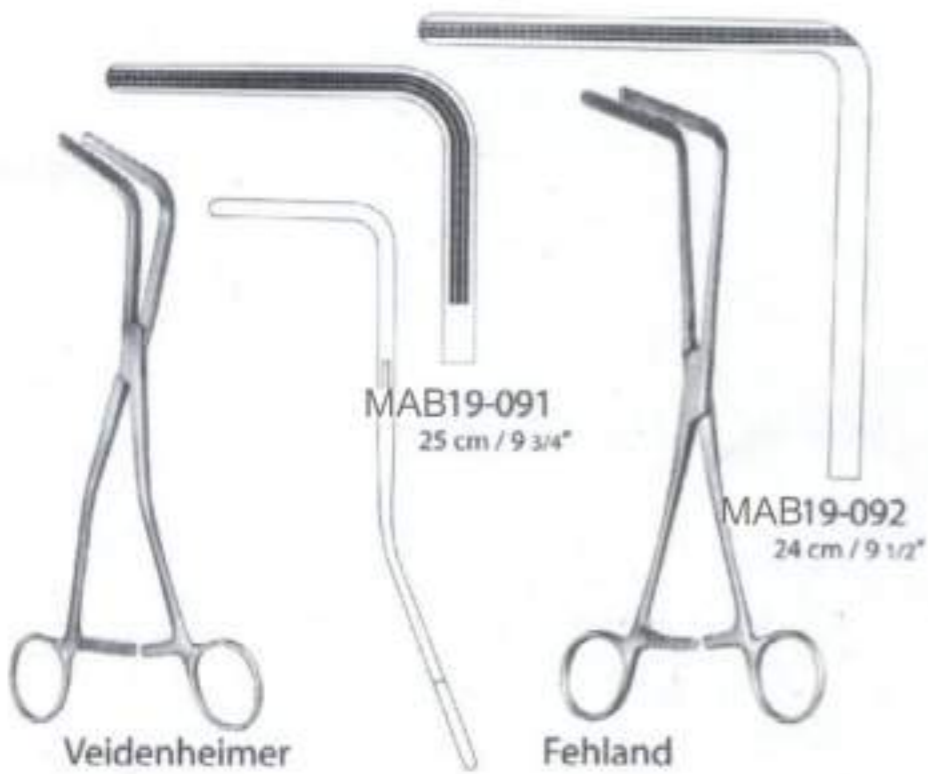



Magen, Darm, Rektum . Stomach, Intestines, Rectum . Estómago, Intestinos, Recto  
**Anal spreizer**  
**Rectal Spreaders**  
**Separadores rectales**  
**Ecarteurs rectaux**  
**Divaricatori rettali**



Alan-Parks  
**MAB19-097**

14 cm / 5 1/2"  
 ohne Kaltlichtaufsatz  
 without F.O. light carrier  
 sin portador de luz fría  
 sans support lumière froide  
 senza supporto per luce fredda

Alan-Parks  
**MAB19-098**

14 cm / 5 1/2"  
 mit Kaltlichtaufsatz  
 with F.O. light carrier  
 con portador de luz fría  
 avec support lumière froide  
 con supporto per luce fredda

**MAB19-099**

Kaltlicht-Aufsatz  
 F.O. light carrier  
 Portador de luz fría  
 Support lumière froide  
 Supporto per luce fredda

Magen, Darm, Rektum . Estomac, Intestin, Rectum . Stomaco, Intestini, Retto  
**Hämorrhoidal-Ligator, Hämorrhoidenfasszange**  
**Hemorrhoidal Grasping Forceps**  
**Ligador para hemorroides, Pinza para hemorroides**  
**Ligateur pour hémorroïdes, Pince pour hémorroïdes**  
**Legatore emorroidale, Pinza per emorroidi**



Rudd

**MAB19-101**

Ladekonus  
 Loading Cone  
 Cone de carga  
 Cône de charge  
 Cono per caricare



McGinvey

**MAB19-102**  
 19 cm / 7 1/2"

Rudd  
**MAB19-100**

Magen, Darm, Rektum . Estomac, Intestins, Rectum . Stomaco, Intestini, Retto  
**Polypenfasszange**  
**Polypus Grasping Forceps**  
**Pinza para coger pólipos**  
**Pince pour saisir polypes**  
**Pinza per afferrare polipi**



**MAB19-110**  
 21 cm / 8 1/4"

Heywood-Smith

Magen, Darm, Rektum . Stomach, Intestines, Rectum . Estómago, Intestinos, Recto  
**Rektum-Biopsiefasszangen**  
**Rectal Biopsy Forceps**  
**Pinzas para biopsia rectal**  
**Pinces pour biopsie rectale**  
**Pinze per biopsia rettale**

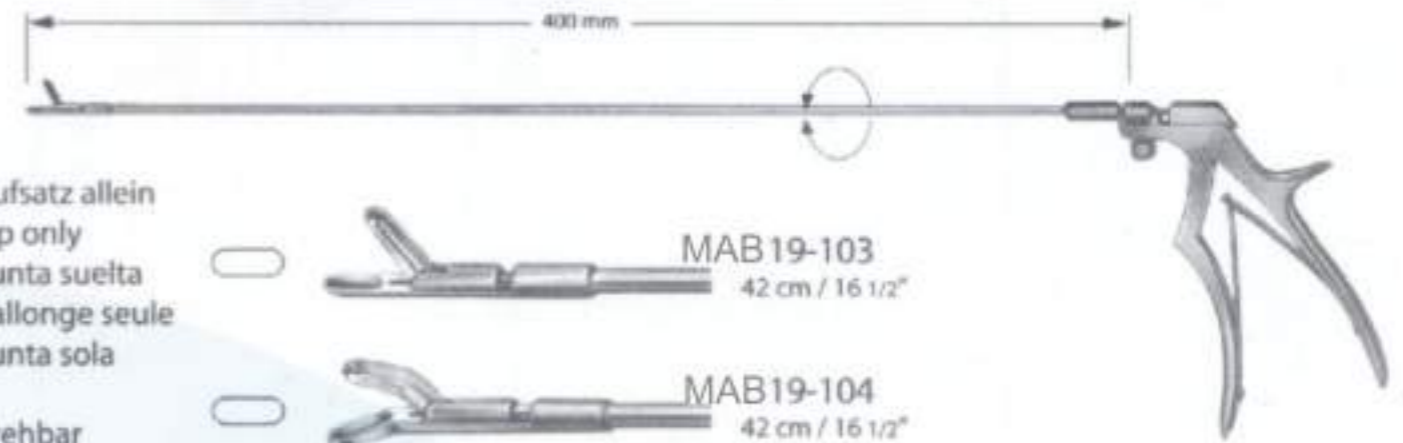

Aufsatz allein  
 Tip only  
 Punta suelta  
 Rallonge seule  
 Punta sola

**MAB19-103**  
 42 cm / 16 1/2"

drehbar  
 rotatable  
 giratorio  
 girevole

**MAB19-104**  
 42 cm / 16 1/2"

**MAB19-105**  
 42 cm / 16 1/2"

**MAB19-106**  
 42 cm / 16 1/2"

**MAB19-107**  
 42 cm / 16 1/2"

**MAB19-108**

Biopsiezangen-Griff  
 Handle for biopsy forceps  
 Mango para pinza de biopsia rectal  
 Manche pour pince pour biopsie rectale  
 Manico per pinza per biopsia rettale

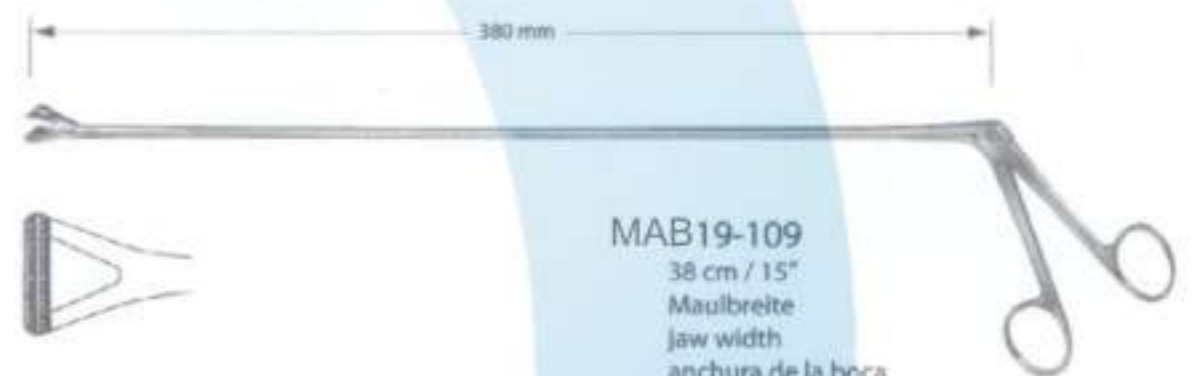

**MAB19-109**  
 38 cm / 15"  
 Maulbreite  
 jaw width  
 anchura de la boca  
 largeur des mors  
 larghezza della bocca  
 15 mm

MAB 20

Urologie  
 Urology  
 Urologia  
 Urologie  
 Urologia

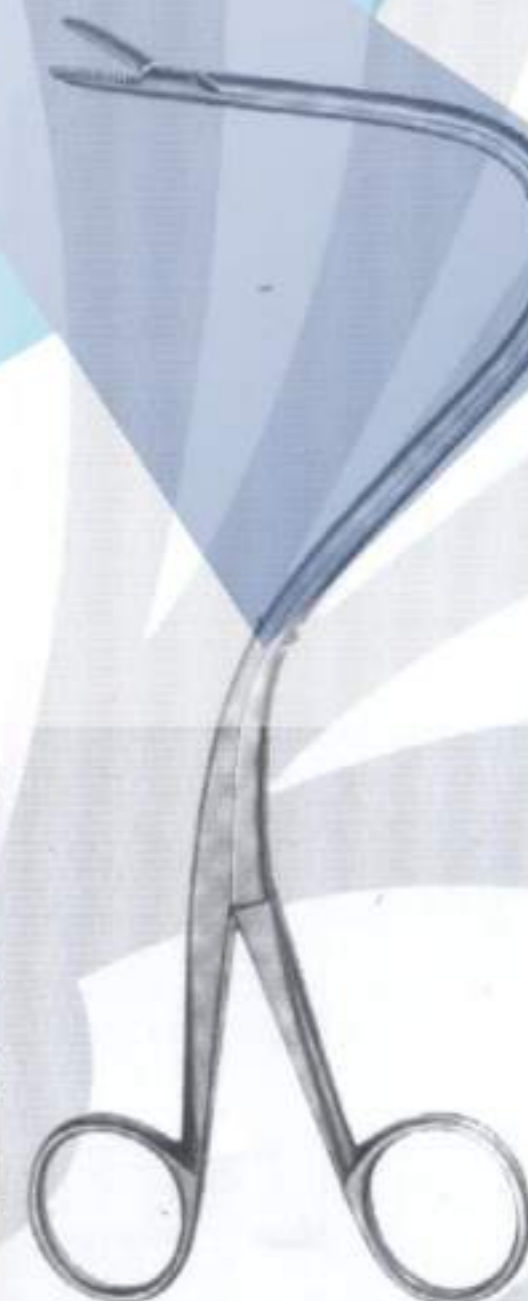



Urologie . Urology . Urologia  
Nierensteinzangen  
Kidney Stone Forceps  
Pinzas para cálculos renales  
Pinces pour les calculs du bassinnet  
Pinze per calcoli renali

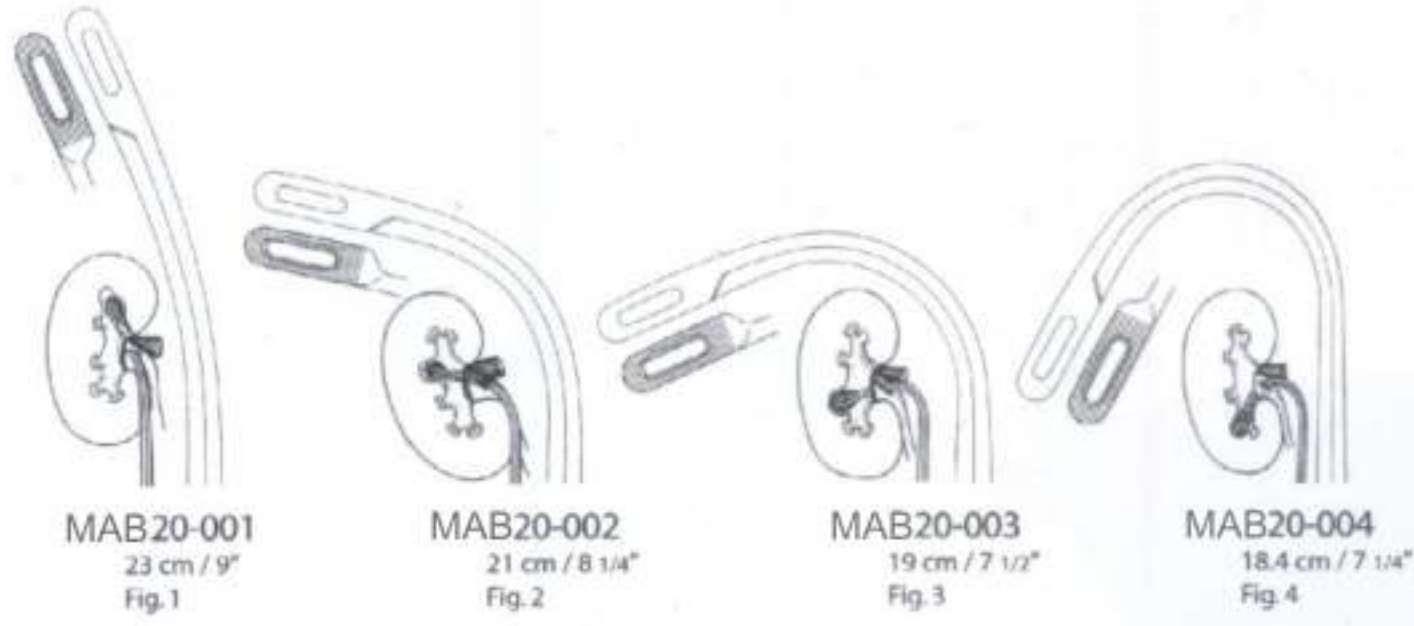

Urologie . Urologie . Urologia  
Nierensteinzangen  
Kidney Stone Forceps  
Pinzas para cálculos renales  
Pinces pour les calculs du bassinnet  
Pinze per calcoli renali

Randall  
besonders feines Modell  
extremely delicate pattern  
modelo extremamente delicado  
modèle extrêmement fin  
modelle estremamente delicato

Heiming  
für Kinder  
for children  
para niños  
pour enfants  
per bambini

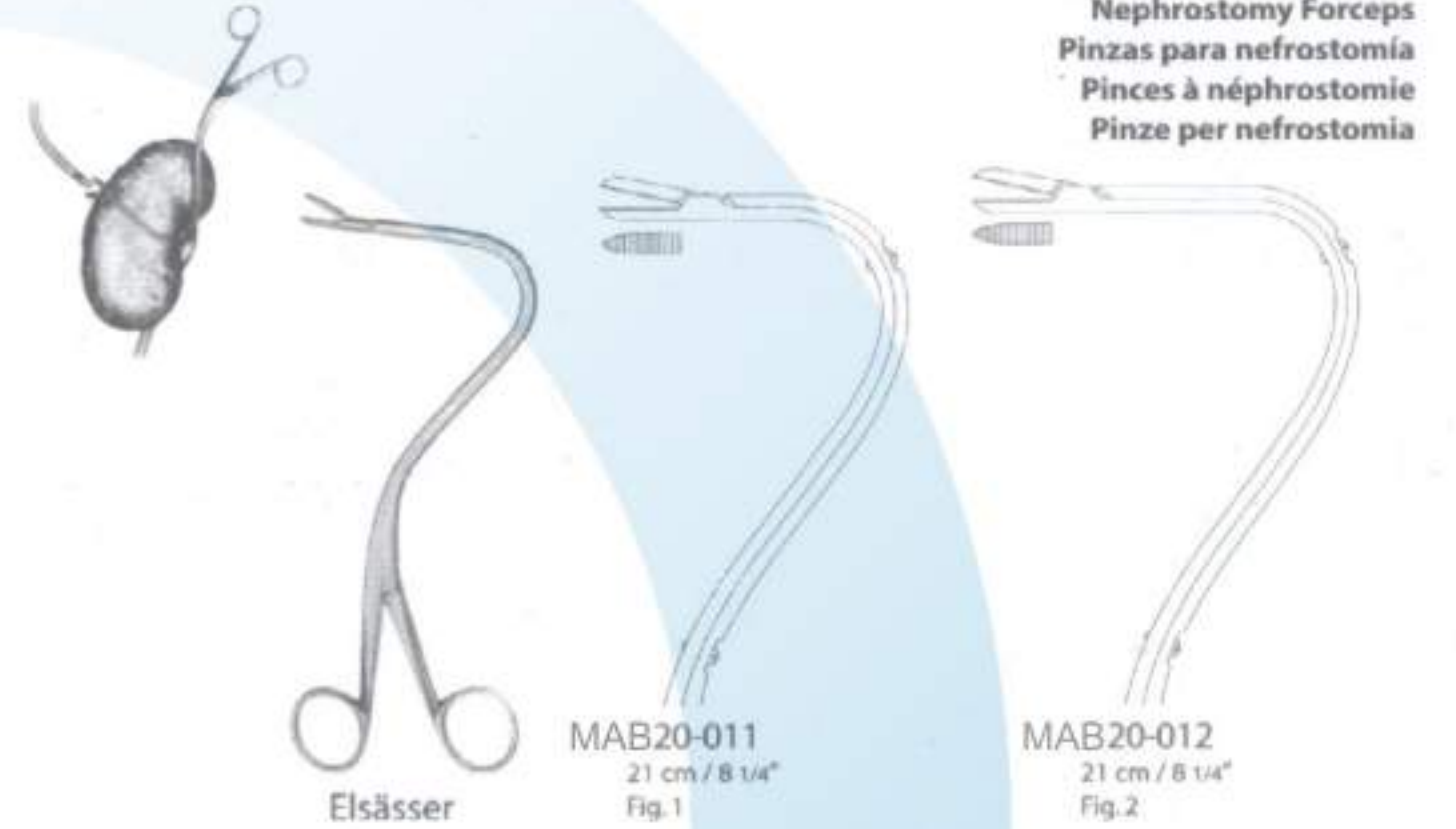

Urologie . Urology . Urologia  
Nierenfistelzangen  
Nephrostomy Forceps  
Pinzas para nefrostomía  
Pinces à néphrostomie  
Pinze per nefrostomia

Urologie . Urologie . Urologia  
Gallenkanaldilatatoren  
Gall Duct Dilators  
Dilatadores para conducto biliar  
Dilatateurs pour les voies biliaires  
Dilatatori per condotti biliari

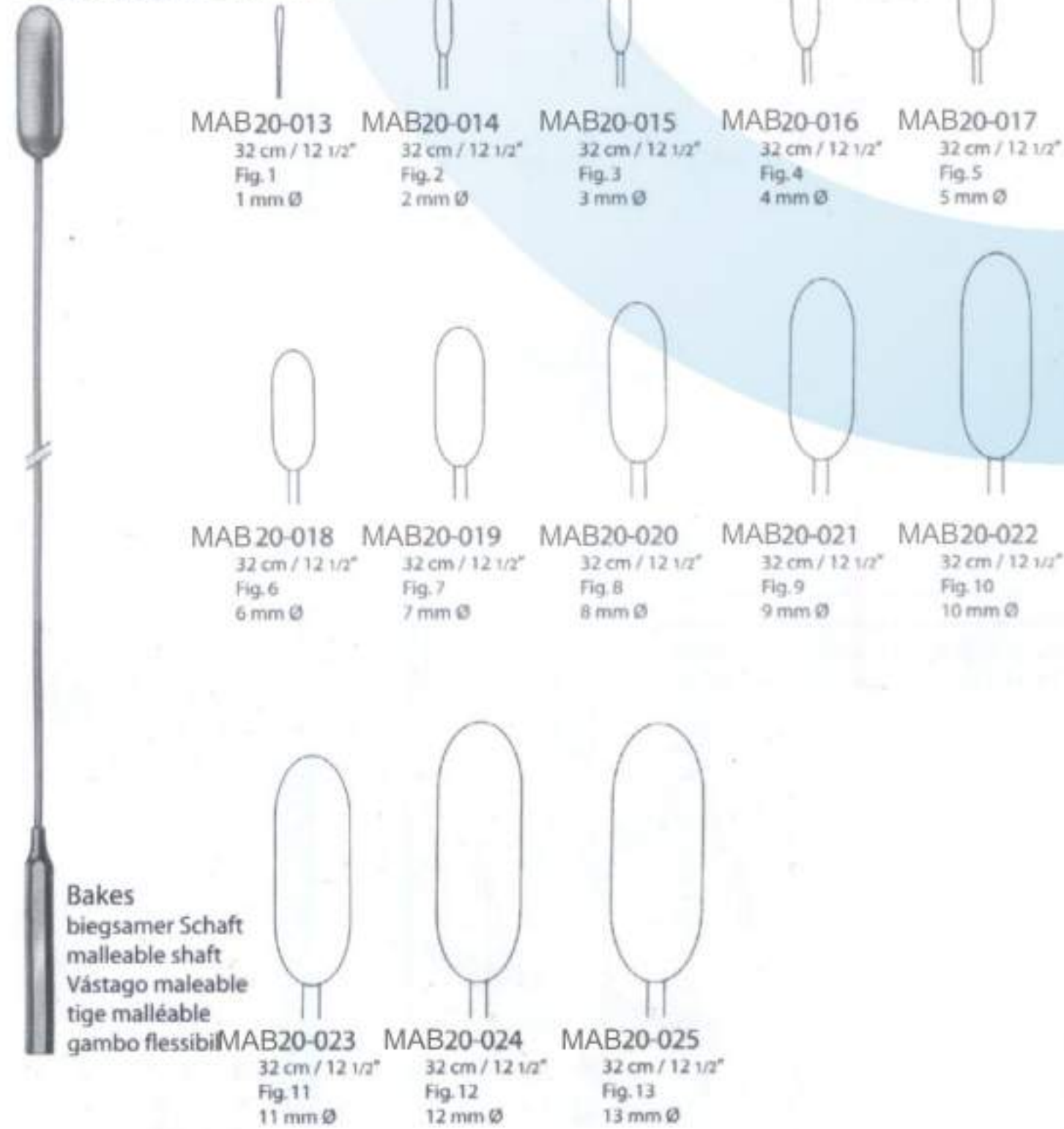

Urologie . Urology . Urologia  
Gallensteinzangen  
Gall Stone Forceps  
Pinzas para cálculos biliares  
Pinces pour calculs biliaires  
Pinze per calcoli biliari

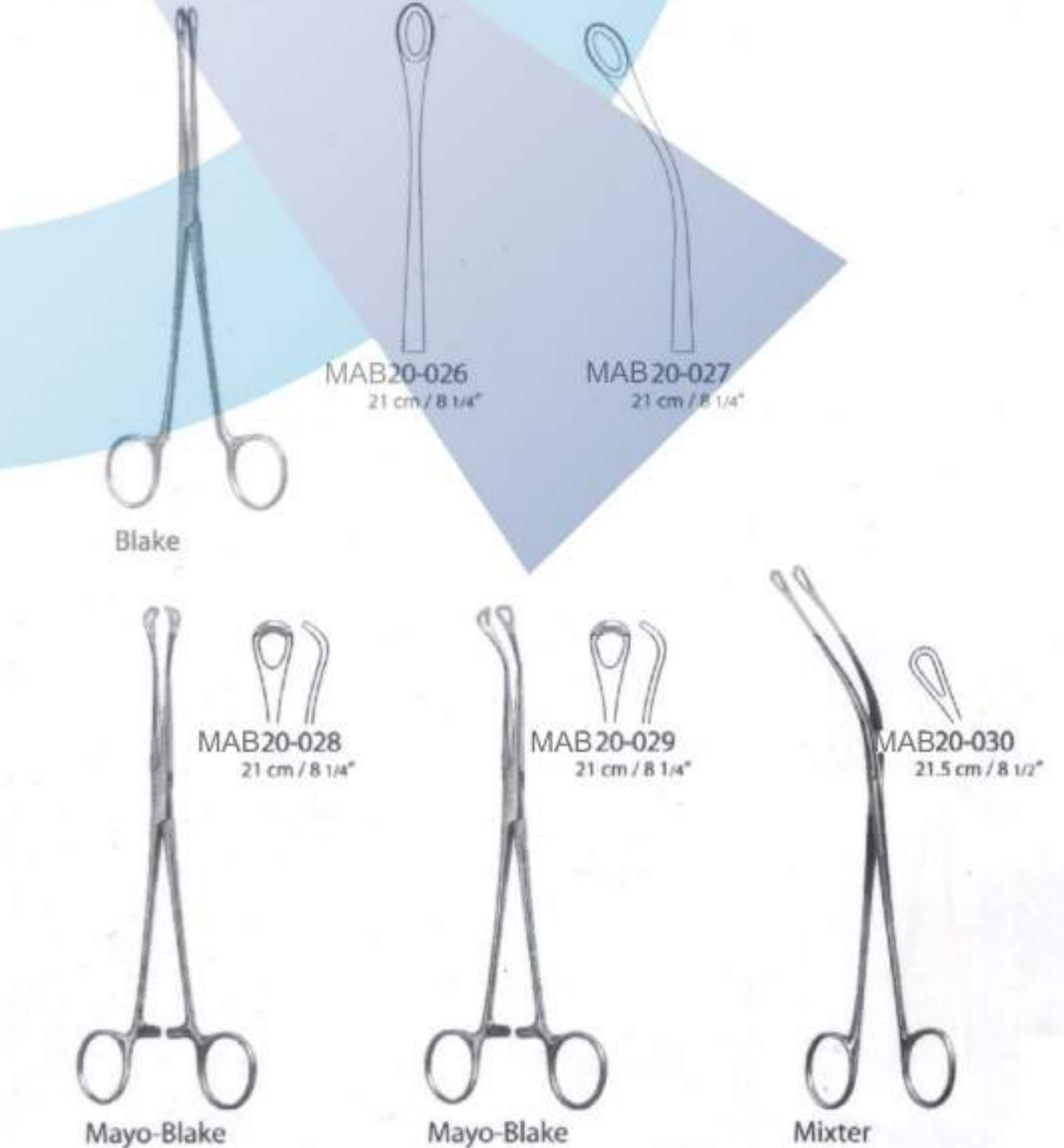

Bakes  
biegsamer Schaft  
malleable shaft  
Vástago maleable  
tige malléable  
gambo flessibile



Urologie . Urologie . Urologia  
Gallensteinzangen  
Gall Stone Forceps  
Pinzas para cálculos biliares  
Pinces pour calculs biliaires  
Pinze per calcoli biliari

MAB 20-031 MAB 20-032  
23 cm / 9" 23 cm / 9"

MAB 20-033 MAB 20-034  
24 cm / 9 1/2" 22.5 cm / 8 3/4"



Desjardins

Desjardins  
sehr schlankes Modell  
very slender pattern  
modelo muy delgado  
modèle très fin  
modello molto delicato

Urologie . Urologie . Urologia  
Gallensteinlöffel  
Gall Stone Scoops  
Cucharas para cálculos biliares  
Curettes pour calculs biliaires  
Pinze per calcoli biliari

MAB 20-035 MAB 20-036 MAB 20-037 MAB 20-038  
32 cm / 12 1/2" 32 cm / 12 1/2" 32 cm / 12 1/2" 32 cm / 12 1/2"  
Fig. 000 Fig. 00 Fig. 0 Fig. 1  
2.5 mm Ø 3.2 mm Ø 3.6 mm Ø 5.5 mm Ø

Luer-Körte  
biegsamer Schaft  
malleable shaft  
Vástago maleable  
tige malléable  
gambo malleabile

MAB 20-039 MAB 20-040 MAB 20-041 MAB 20-042  
32 cm / 12 1/2" 32 cm / 12 1/2" 32 cm / 12 1/2" 32 cm / 12 1/2"  
Fig. 2 Fig. 3 Fig. 4 Fig. 5  
6.7 mm Ø 8.0 mm Ø 11 mm Ø 15 mm Ø

Urologie . Urologie . Urologia  
Prostatahaken  
Prostatic Retractors  
Separadores para próstata  
Ecarteurs prostatiques  
Divaricatori prostatici



Young MAB 20-043 21.5 cm / 8 1/2"  
Young MAB 20-044 20.5 cm / 8"  
Young MAB 20-045 22 cm / 8 3/4"  
Young MAB 20-046 21.5 cm / 8 1/2"

Urologie . Urology . Urologia  
Kapselzangen  
Capsule Forceps  
Pinzas capsulares  
Pinces pour saisir les capsules  
Pinze per afferrare capsule



Millin



Millin

Urologie . Urologie . Urologia  
Kapselzangen, Fadenführungszange  
Capsule Forceps, Ligature Carrying Forceps  
Pinzas capsulares, Pinza porta ligaduras  
Pinces pour saisir les capsules, Pinze porta-filo  
Pinze per afferrare capsule, Pinza porta-filo



Millin

Millin

Millin

Urologie . Urology . Urologia  
Blasenhalssperrerr, Blasenwundsperrerr  
Bladder Neck Spreader, Bladder Retractors  
Dilatador para el cuello vesical, Separadores vesicales  
Ecarteur pour le col de la vessie, Ecarteurs vésicaux  
Divaricatore del collo vescicale, Divaricatore vescicale



Millin MAB 20-052 29 cm / 11 1/2"



Thomson-Walker

MAB 20-053  
komplett mit  
2 Paar Seitenvalven,  
1 Mittelvalve und  
1 Retraktor  
complete with  
2 pairs of lateral  
blades,  
1 central blade and  
1 retractor  
completo con 2  
pares de valvas  
laterales,  
complet, avec  
2 paires de valves  
latérales  
1 valve centrale et  
1 écarteur  
completo, con  
2 paia di valve  
laterali  
1 valva centrale e  
1 retrattore

Urologie . Urologie . Urologia  
Blasenwundsperrerr, Blasenspatel  
Bladder Retractors, Bladder Spatula  
Separadores vesicales, Espátula vesical  
Ecarteur vésicaux, Spatule vésicale  
Divaricatore vescicale, Spatole vescicali



Judd-Masson MAB 20-054



Legueu MAB 20-055 24 cm / 9 1/2"



Urologie . Urology . Urología  
 Blasenwundsperrer  
 Bladder Retractors  
 Separadores vesicales  
 Ecarteur vésicaux  
 Divaricatore vescicale



**MAB 20-056**  
 komplett, mit je 2 Seitenvlaven  
 57 x 25 mm und 80 x 25 mm,  
 sowie 1 Mittelvalve 120 x 45 mm  
 ohne Kaltichtaufsatz

complete, with 2 pairs of lateral  
 blades 57 x 25 mm and 80 x 25  
 mm and 1 central blade 120 x  
 45 mm without F.O. Carrier

completo con 2 pares de valvas  
 laterales 57 x 25 mm, y 80 x 25  
 mm, y una valva central 120 x  
 45 mm sin portador de luz fría

complet, avec 2 paires de valves  
 latérales 57 x 25 mm et 80 x 25  
 mm, ainsi qu'une valve centrale  
 120 x 45 mm sans support  
 lumière froide

completo, con 2 paia di valve  
 laterali 57 x 25 mm e 80 x 25  
 mm, in più 1 valva centrale 120  
 x 45 mm senza supporto per  
 luce fredda

Millin

Urologie . Urologie . Urologia  
 Harnröhrenbougies  
 Urethral Sounds  
 Bujías uretrales  
 Bougies urétrales  
 Candelette dilatatrici



mm Ø	Charrière	van Buren	Guyon
2	6		
2 1/3	7		
2 2/3	8		
3	9		
3 1/3	10	MAB20-063	
3 2/3	11		
4	12	MAB20-064	MAB20-078 MAB20-098
4 1/3	13		MAB20-079
4 2/3	14	MAB20-065	MAB20-080 MAB20-099
5	15		MAB20-081
5 1/3	16	MAB20-066	MAB20-082 MAB20-100
5 2/3	17		MAB20-083
6	18	MAB20-067	MAB20-084 MAB20-101
6 1/3	19		MAB20-085
6 2/3	20	MAB20-068	MAB20-086
7	21		MAB20-087
7 1/3	22	MAB20-069	MAB20-088
7 2/3	23		MAB20-089
8	24	MAB20-070	MAB20-090
8 1/3	25		MAB20-091
8 2/3	26	MAB20-071	MAB20-092
9	27		MAB20-093
9 1/3	28	MAB20-072	MAB20-094
9 2/3	29		MAB20-095
10	30	MAB20-073	MAB20-096
10 1/3	31		
10 2/3	32	MAB20-074	
11	33		
11 1/3	34	MAB20-075	
11 2/3	35		
12	36	MAB20-076	

Van Buren Guyon  
 MAB20-057-MAB20-059- MAB20-061-  
 MAB20-058 MAB20-060 MAB20-062

Metalkatheter für  
 Frauen  
 Metal Catheters,  
 Sondas metálicas,  
 femininas  
 Sondes métalliques,  
 pour femmes  
 Sonde metalliche,  
 per donne

MAB20-077  
 Satz Kompleft  
 complete set  
 juego completo  
 jeu complet  
 set completo

Urologie . Urology . Urologia  
 Gleitsonde, Harnröhrenbougies  
 Filiform Bougie, Urethral Sounds  
 Sonda filiforme, Bujías uretrales  
 Bougie conductrice, Bougies urétrales  
 Candelette filiforme, Candelette dilatatrici



**Guyon**  
**MAB 20-106**  
 Satz mit 21 Bougies, Charr.10 bis 30  
 mit 4 Gleitsonden  
 im Metalletui 42 x 17.5 x 4 cm  
 set with 21 bougies, Charr. 10 to 30  
 with 4 filiform bougies  
 in metal case 42 x 17.5 x 4 cm  
 juego de 21 bujías, Charr. 10 a 30  
 con 4 bujías filiformes  
 en caja metálica 42 x 17.5 x 4 cm  
 jeu avec 4 bougies conductrices  
 en boîte métal 42 x 17.5 x 4 cm  
 set di 21 dilatatori, Charr. 10 fino a 30  
 con 4 candelette delatatrici  
 in contenitore metallico 42 x 17.5 x 4 cm

**Filiform**  
 mit Schraubgewinde-Ansatz  
 with screw thread  
 con rosca de tornillo  
 avec embout fileté  
 con attacco filettato

MAB20-102 charr.3  
 MAB20-103 charr.4  
 MAB20-104 charr.5  
 MAB20-105 charr.6

Urologie . Urologie . Urologia  
 Urethrotom  
 Urethrotome  
 Uretrótomo  
 Urétrótome  
 Uretrotomi

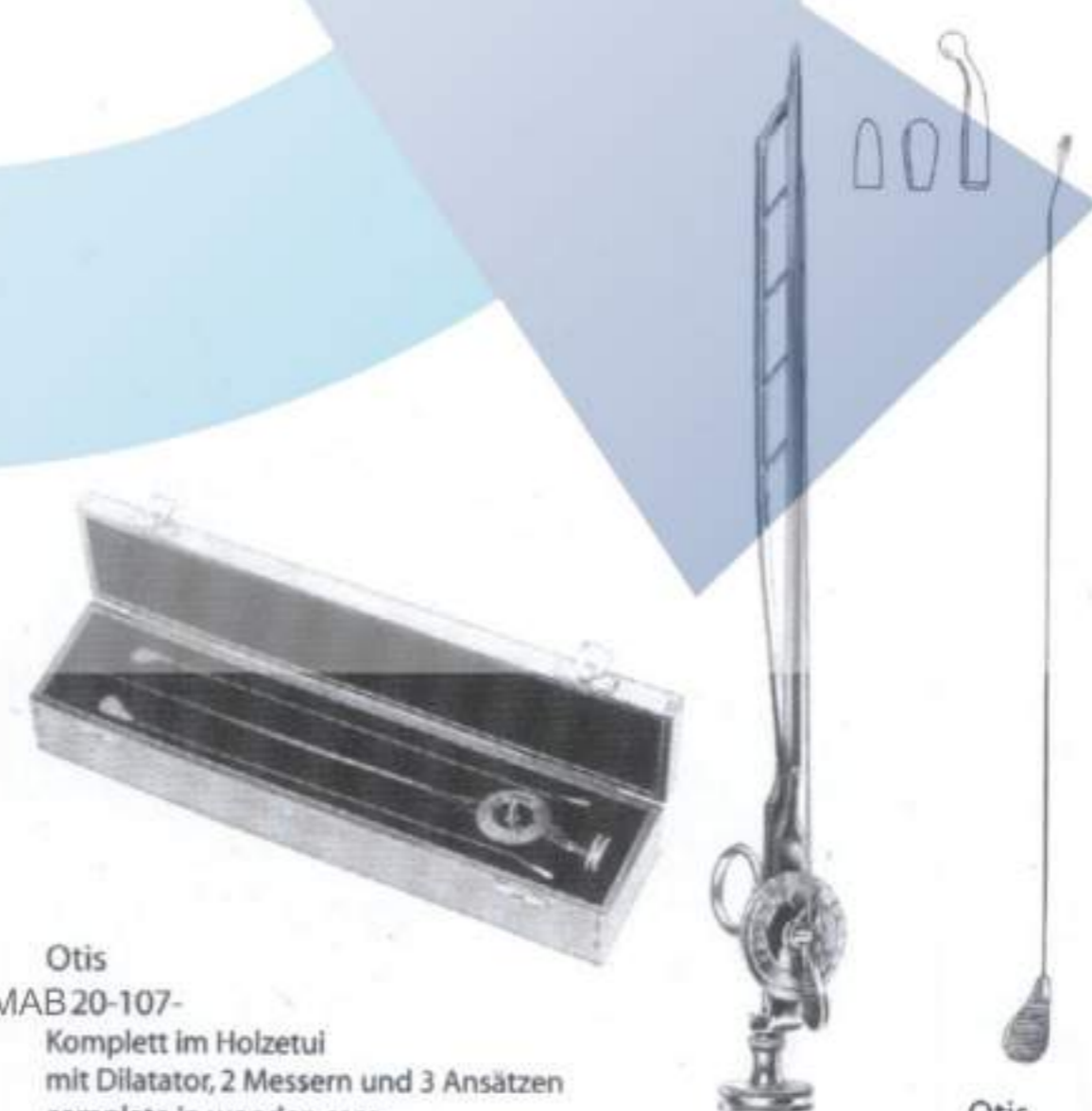

**Otis**  
**MAB 20-107-**  
 Komplett im Holzetui  
 mit Dilator, 2 Messern und 3 Ansätzen  
 complete in wooden case  
 with dilator, 2 Knives and 3 tips  
 completo en caja de madera  
 con dilatador, 2 cuchillos y 3 puntas  
 complet, en boîte métal  
 avec dilataateur, 2 lames et 3 embouts  
 completo, in contenitore di legno  
 con dilatatore, 2 disturi e 3 punte

**Otis**  
**MAB20-108-**  
 Ersatzmesser  
 Spare Blade  
 Cuchillo de repuesto  
 Couteau de rechange  
 Lama di ricambio



Urologie . Urology . Urologia  
 Urethrographie- und Circumcisions-Instrumente  
 Urethrography- and Circumcision Instruments  
 Instrumentos para uretrografia y circuncisión  
 Instruments pour urétrographie et circoncision  
 Strumenti per uretrografia e circoncisione



Knutson  
MAB 20-109-

Urethrographieinstrument  
 Urethrography Instrument  
 Instrumento para uretrografia  
 Instrument pour urétrographie  
 Strumento per uretrografia

Knutson-Koch  
MAB 20-110-

Konus  
Cone  
Cono  
Cône  
Cono



Circumcisionerät  
 Circumcision Instrument  
 Instrument para circuncisión  
 Instrument de circuncision  
 Strumento per circoncisione

- |           |         |
|-----------|---------|
| MAB20-111 | 8 mm Ø  |
| MAB20-112 | 11 mm Ø |
| MAB20-113 | 13 mm Ø |
| MAB20-114 | 16 mm Ø |
| MAB20-115 | 21 mm Ø |
| MAB20-116 | 26 mm Ø |
| MAB20-117 | 18 mm Ø |
| MAB20-118 | 10 mm Ø |
| MAB20-119 | 32 mm Ø |



Mogen  
MAB 20-120

7.5 cm / 3"  
 Beschneidungsinstrument  
 Circumcision Instrument  
 Instrumento para circuncisión  
 Instrument de circuncision  
 Strumento per circoncisione

Urologie . Urologie . Urologia  
 Kathetereinführinstrumente  
 Catheter Guides  
 Mandriles para catéteres  
 Mandrins pour sondes urétrales  
 Mandrini per sonde uretrali



Guyon  
MAB 20-121

40 cm / 15 3/4"

Guyon  
MAB 20-122

37 cm / 14 1/2"



Stockmann  
MAB 20-123  
8 cm / 3 1/4"  
Penisklemme  
Penis Clamp  
Clamp para pene  
Pince pour pénis  
serrapene



Strauss  
MAB 20-124  
11 cm / 4 1/4"  
Penisklemme  
Penis Clamp  
Clamp para pene  
Pince pour pénis  
serrapene

Urologie . Urology . Urologia  
 Fremdkörperzangen, Meatotom  
 Foreign Body Forceps, Meatotome  
 Pinzas para cuerpos extraños, Meatotomo  
 Pinces pour corps étrangers, Méatotome  
 Pinze per corpi estranei, Meatotomo



Mathieu  
MAB 20-125  
Schaftlänge  
length of shaft  
longitud del vástago  
longueur du tige  
lunghezza del gambo  
200 mm

Mathieu  
MAB 20-127  
Schaftlänge  
length of shaft  
longitud del vástago  
longueur du tige  
lunghezza del gambo  
300 mm



Sachse  
MAB 20-126  
12 cm / 14 1/2"

## MAB 21

Gynäkologie  
 Gynecology  
 Ginecologia  
 Gynecologie  
 Ginecologia

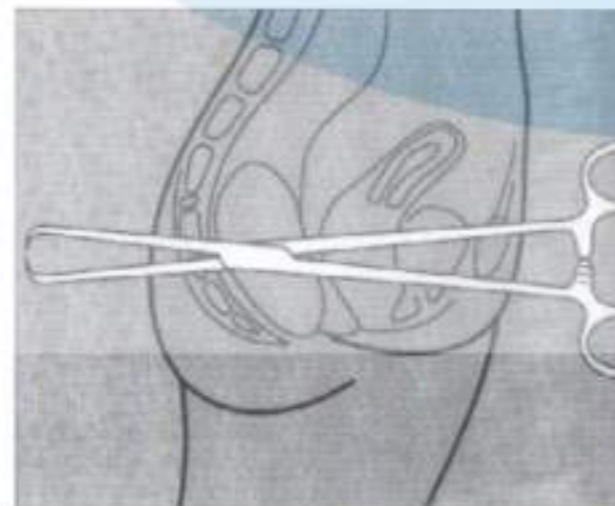

Gynäkologie . Gynecology . Ginecologia  
 Vaginalspekula  
 Vaginal Specula  
 Espéculos Vaginales  
 Spéculums vaginaux  
 Specoli vaginali



Cusco  
MAB 21-001 = 75 x 32 mm  
 MAB 21-002 = 85 x 35 mm  
 MAB 21-003 = 100 x 35 mm



Cusco  
MAB 21-004 = 75 x 18 mm



Cusco  
MAB 21-005 = 80 x 22 mm  
 MAB 21-006 = 100 x 25 mm  
 MAB 21-007 = 105 x 27 mm



Cusco  
MAB 21-008 = 75 x 34 mm  
 MAB 21-009 = 85 x 37 mm  
 MAB 21-010 = 100 x 37 mm



Collin  
MAB 21-011 = 85 x 30 mm  
 MAB 21-012 = 100 x 35 mm  
 MAB 21-013 = 110 x 40 mm



Pederson  
MAB 21-014 = 75 x 13 mm  
 MAB 21-015 = 100 x 22 mm  
 MAB 21-016 = 120 x 25 mm



Grave  
MAB 21-017 = 75 x 20 mm  
 MAB 21-018 = 95 x 35 mm  
 MAB 21-019 = 115 x 35 mm



Semm  
MAB 21-020 = 100 x 20 mm  
 MAB 21-021 = 105 x 27 mm



Gynäkologie . Gynecology . Ginecologia  
 Vaginalsepekula, Scheidenhalter  
 Vaginal Specula, Vaginal Retractors  
 Espéculos Vaginales, Valvas vaginales  
 Spéculum vaginaux, Valves vaginales  
 Specoli vaginali, Valve vaginali



**Sims**  
 MAB21-022 = 65 x 25 mm / 70 x 30 mm  
 MAB21-023 = 70 x 30 mm / 70 x 35 mm  
 MAB21-024 = 85 x 35 mm / 90 x 40 mm



**Kristeller**  
 MAB21-025 = Fig.1 70 x 27 mm  
 MAB21-026 = Fig.2 80 x 30 mm  
 MAB21-027 = Fig.3 90 x 36 mm

Gynäkologie . Gynecologie . Ginecologia  
 Vaginalsepekula, Scheidenhalter  
 Vaginal Specula, Vaginal Retractors  
 Espéculos Vaginales, Valvas vaginales  
 Spéculum vaginaux, Valves vaginales  
 Specoli vaginali, Valve vaginali

schlankes Modell  
 slender pattern  
 modelo delgado  
 modèle gracile  
 modello delicato



**Kristeller**  
 MAB21-034 = Fig.1 105 x 18 mm  
 MAB21-035 = Fig.2 105 x 21 mm  
**Kristeller**  
 MAB 21-036 = Fig.1 110 x 14 mm  
 MAB 21-037 = Fig.2 110 x 17 mm



Satz Fig. bestehend aus  
 set no. consisting of  
 juego no. consiste de  
 jeu no. se composant de  
 serie no. composto da

**Kristeller**  
 S 21-028 = Fig.1 75 x 23 mm  
 S 21-029 = Fig.2 85 x 26 mm  
 S 21-030 = Fig.3 100 x 32 mm  
**Kristeller**  
 MAB21-031 1 32-182-01 + 32-183-01 75 x 23 mm 70 x 27 mm  
 MAB21-032 2 32-182-02 + 32-183-02 85 x 26 mm 80 x 30 mm  
 MAB21-033 3 32-182-03 + 32-183-03 100 x 32 mm 90 x 36 mm



**Kristeller**  
 MAB21-038 1 32-190-01 + 32-191-01 105 x 18 mm 110 x 14 mm  
 MAB21-039 2 32-190-02 + 32-191-02 105 x 21 mm 110 x 17 mm

Satz Fig. bestehend aus  
 set no. consisting of  
 juego no. consiste de  
 jeu no. se composant de  
 serie no. composto da

Gynäkologie . Gynecology . Ginecologia  
 Vaginalsepekula, Scheidenhalter  
 Vaginal Specula, Vaginal Retractors  
 Espéculos Vaginales, Valvas vaginales  
 Spéculum vaginaux, Valves vaginales  
 Specoli vaginali, Valve vaginali



flaches Spekulum  
 flat speculum  
 espéculo plano  
 spéculum plat  
 specolo piatto



**Kristeller**  
 MAB21-040 = Fig.1 105 x 26 mm  
 MAB21-041 = Fig.2 105 x 28 mm  
 MAB21-042 = Fig.3 105 x 33 mm  
**Kristeller**  
 MAB21-043 = Fig.1 115 x 22 mm  
 MAB21-044 = Fig.2 115 x 24 mm  
 MAB21-045 = Fig.3 115 x 29 mm

Gynäkologie . Gynecologie . Ginecologia  
 Vaginalsepekula, Scheidenhalter  
 Vaginal Specula, Vaginal Retractors  
 Espéculos Vaginales, Valvas vaginales  
 Spéculum vaginaux, Valves vaginales  
 Specoli vaginali, Valve vaginali



tiefes Spekulum  
 deep speculum  
 espéculo profundo  
 spéculum profond  
 specolo profondo



**Kristeller**  
 MAB 21-049 = Fig.1 110 x 27 mm  
 MAB 21-050 = Fig.2 110 x 30 mm  
 MAB 21-051 = Fig.3 110 x 36 mm  
**Kristeller**  
 MAB21-052 = Fig.1 115 x 23 mm  
 MAB21-053 = Fig.2 115 x 26 mm  
 MAB21-054 = Fig.3 115 x 32 mm



**Kristeller**  
 MAB 21-046 1 32-196-01 + 32-197-01 105 x 26 mm 115 x 22 mm  
 MAB21-047 2 32-196-02 + 32-197-02 105 x 28 mm 115 x 24 mm  
 MAB21-048 3 32-196-03 + 32-197-03 105 x 33 mm 115 x 29 mm

Satz Fig. bestehend aus  
 set no. consisting of  
 juego no. consiste de  
 jeu no. se composant de  
 serie no. composto da



**Kristeller**  
 MAB21-055 1 32-202-01 + 32-203-01 110 x 27 mm 115 x 23 mm  
 MAB21-056 2 32-202-02 + 32-203-02 110 x 30 mm 115 x 26 mm  
 MAB21-057 3 32-202-03 + 32-203-03 110 x 36 mm 115 x 32 mm

Satz Fig. bestehend aus  
 set no. consisting of  
 juego no. consiste de  
 jeu no. se composant de  
 serie no. composto da



Gynäkologie . Gynecology . Ginecología  
 Vaginalsepekula, Scheidenhalter  
 Vaginal Specula, Vaginal Retractors  
 Espéculos Vaginales, Valvas vaginales  
 Spéculums vaginaux, Valves vaginales  
 Specoli vaginali, Valve vaginali



Kallmorgen  
 MAB 21-058 = Fig.1 70 X 40 mm  
 MAB 21-059 = Fig.2 90 X 40 mm



Gynäkologie . Gynécologie . Ginecologia  
 Vaginalsepekula  
 Vaginal Specula  
 Espéculos Vaginales  
 Spéculums vaginaux  
 Specoli vaginali



leicht hohl  
 slightly concave  
 ligeramente cóncavo  
 légèrement concave  
 leggermente concavo

- MAB 21-062 = Fig.1 63 x 35 mm
- MAB 21-063 = Fig.2 94 x 35 mm
- MAB 21-064 = Fig.3 124 x 35 mm
- MAB 21-065 = Fig.1 66 x 47 mm
- MAB 21-066 = Fig.2 95 x 47 mm
- MAB 21-067 = Fig.3 126 x 47 mm
- MAB 21-068 = Fig.4 160 x 47 mm
- MAB 21-069 = Fig.1 55 x 60 mm
- MAB 21-070 = Fig.2 95 x 60 mm
- MAB 21-071 = Fig.3 130 x 60 mm
- MAB 21-072 = Fig.4 175 x 60 mm

Doyen

Gynäkologie . Gynecology . Ginecología  
 Vaginalsepekula  
 Vaginal Specula  
 Espéculos Vaginales  
 Spéculums vaginaux  
 Specoli vaginali

Scherbak  
 Blatt, allein  
 Specula Blade, only  
 Valva vaginal, suelta  
 Valve vaginale, seule  
 Valve vaginale, sola



MAB 21-073  
 Satz komplett mit Griff, Gewicht  
 (400 g) und 5 Blättern  
 complete set with handle, weight  
 (400 g) and 5 blades  
 juego completo con mango, peso  
 (400 g) y 5 baldes  
 jeu complet avec manche, poids  
 (400 g) et 5 valves  
 set completo con manico, peso  
 (400 g) e 5 valve



MAB 21-074  
 80 x 30 mm

MAB 21-075  
 85 x 35 mm

MAB 21-076  
 90 x 40 mm

Satz Fig.  
 set no.  
 juego no.  
 jeu no.  
 serie no.

bestehend aus  
 consisting of  
 consiste de  
 se componant de  
 composto

Kallmorgen		Satz Fig. set no.	bestehend aus consisting of
MAB 21-060	1	32-232-01 + 32-233-01	70 X 40 mm 70 x 33 mm
MAB 21-061	2	32-232-02 + 32-233-02	90 X 40 mm 90 x 33 mm

Gynäkologie . Gynécologie . Ginecología  
 Vaginalsepekula  
 Vaginal Specula  
 Espéculos Vaginales  
 Spéculums vaginaux  
 Specoli vaginali



Scherbak  
 Blatt, allein  
 Specula Blade, only  
 Valva vaginal, suelta  
 Valve vaginale, seule  
 Valve vaginale, sola



MAB 21-077  
 62 x 40 - 60 mm



MAB 21-078  
 81 x 45 - 70 mm

Gynäkologie . Gynecology . Ginecologia  
 Vaginalsepekula  
 Vaginal Specula  
 Espéculos Vaginales  
 Spéculums vaginaux  
 Specoli vaginali



S 21-082  
 Auffangsieb  
 Strainer for Vaginal  
 Speculum  
 Tamiz para  
 espéculo vaginal  
 Tamis pour  
 Spéculum vaginal  
 Crivello per  
 specolo vaginale



S 21-083  
 80 x 42 mm  
 komplett, mit  
 abnehmbarem  
 Auffangsieb  
 complete, with  
 detachable strainer  
 completo, con tamiz  
 desmontable  
 complet avec tamiz  
 démontable  
 completo con crivello  
 smontabile

Weissbarth

S 21-084  
 80 x 43 mm  
 komplett, mit  
 abnehmbarem Gewicht  
 complete, with  
 detachable weight  
 completo, con peso  
 desmontable  
 complet avec poids  
 démontable  
 completo don peso  
 smontabile



Auvard

70 x 30 mm



MAB 21-079  
 10,5 cm / 4"  
 400 g

Scherbak  
 Gewicht zum  
 Vaginalsepekulum  
 Weight for Vaginal  
 Speculum  
 Peso para espéculo  
 vaginal  
 Poids pour spéculum  
 vaginal  
 Peso per specolo  
 vaginale

MAB 21-080  
 13 cm / 5"  
 800 g



Scherbak

MAB 21-081  
 20 cm / 8"  
 Griff zum  
 Vaginalsepekulum  
 Handle for Vaginal  
 Speculum  
 Mango para  
 espéculo vaginal  
 Manche pour  
 spéculum vaginal  
 Manico per specolo  
 vaginale



Breisky

- MAB 21-085 = 100 x 20 mm
- MAB 21-086 = 100 x 25 mm
- MAB 21-087 = 100 x 30 mm
- MAB 21-088 = 100 x 35 mm
- MAB 21-089 = 100 x 40 mm

- MAB 21-090 = 130 x 20 mm
- MAB 21-091 = 130 x 25 mm
- MAB 21-092 = 130 x 30 mm
- MAB 21-093 = 130 x 35 mm
- MAB 21-094 = 130 x 40 mm

- MAB 21-095 = 155 x 40 mm



Doyen  
 MAB 21-096  
 25 cm / 9 3/4"



Gynäkologie . Gynecology . Ginecologia  
Endospekula  
Endocervical Specula  
Espéculos endocervicales  
Endospéculums  
Endospecoli

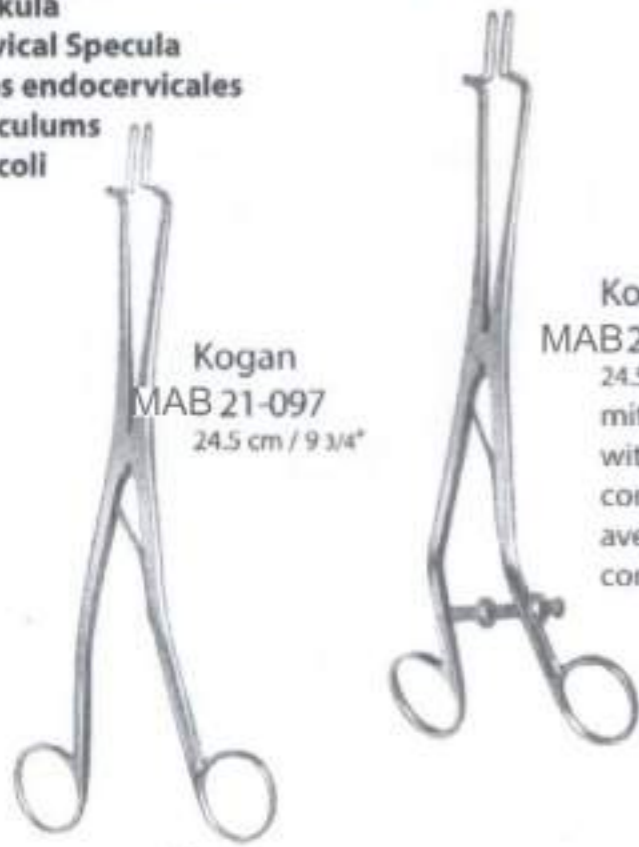

Kogan  
MAB 21-097  
24.5 cm / 9 3/4"

Kogan  
MAB 21-098  
24.5 cm / 9 3/4"  
mit skaliertem Sperre und Fixierschraube  
with graduated ratchet and fixing screw  
con cremallera graduada y tornillo de fijación  
avec crémaillère à échelle et vis à fixation  
con cremagliera con scala e vite di fissaggio

Gynäkologie . Gynecologie . Ginecologia  
Uterusdilatoren  
Uterine Dilators  
Dilatadores uterinos  
Dilatateurs du col de l'utérus  
Dilatatori uterini

mm Ø	MAB 21-099	MAB 21-110
1.0	MAB 21-099	MAB 21-110
1.5	MAB 21-100	MAB 21-111
2.0	MAB 21-101	MAB 21-112
2.5	MAB 21-102	MAB 21-113
3.0	MAB 21-103	MAB 21-114
3.5	MAB 21-104	MAB 21-115
4.0	MAB 21-105	MAB 21-116
4.5	MAB 21-106	MAB 21-117
5.0	MAB 21-107	MAB 21-118
5.5	MAB 21-108	MAB 21-119
6.0	MAB 21-109	MAB 21-120
6.5		
7.0		
7.5		
8.0		
8.5		
9.0		
9.5		
10.0		
10.5		
11.0		
11.5		

Hegar

12.0	MAB 21-121
12.5	MAB 21-122
13.0	MAB 21-123
13.5	MAB 21-124
14.0	MAB 21-125
14.5	MAB 21-126
15.0	MAB 21-127
15.5	MAB 21-128
16.0	MAB 21-129
16.5	MAB 21-130
17.0	MAB 21-131
17.5	MAB 21-132
18.0	MAB 21-133
18.5	MAB 21-134
19.0	MAB 21-135
19.5	
20.0	
20.5	
21.0	
21.5	
22.0	
22.5	
23.0	
23.5	
24.0	
24.5	
25.0	
25.5	
26.0	

Gynäkologie . Gynecology . Ginecologia  
Uterusdilatoren  
Uterine Dilators  
Dilatadores uterinos  
Dilatateurs du col de l'utérus  
Dilatatori uterini



Hegar

MAB 21-142  
Satz mit 14 Stück (ganze Größen)  
von 4.0 bis 17.0 mm  
ohne Etui  
set of 14 pieces (full sizes)  
from 4.0 to 17.0 mm  
without case  
juego de 14 piezas (tamaños enteros)  
de 4.0 a 17.0 mm  
sin caja  
jeu de 14 pièces (taille entière)  
de 4.0 jusqu'à 17.0 mm  
sans boîte  
serie di 14 pezzi (grandezza intera)  
da 4.0 fino a 17.0 mm  
senza scatola

MAB 21-143  
Satz mit 14 Stück (ganze Größen)  
von 4.0 bis 17.0 mm  
in Metalletui  
set of 14 pieces (full sizes)  
from 4.0 to 17.0 mm  
in metal case  
juego de 14 piezas (tamaños enteros)  
de 4.0 a 17.0 mm  
en caja metálica  
jeu de 14 pièces (taille entière)  
de 4.0 jusqu'à 17.0 mm  
en boîte métal  
serie di 14 pezzi (grandezza intera)  
da 4.0 fino a 17.0 mm  
in scatola metallica

MAB 21-144  
Satz mit 26 Stück (ganze Größen)  
von 1.0 bis 26.0 mm  
ohne Etui  
set of 26 pieces (full sizes)  
from 1.0 to 26.0 mm  
without case  
juego de 26 piezas (tamaños enteros)  
de 1.0 a 26.0 mm  
sin caja  
jeu de 26 pièces (taille entière)  
de 1.0 jusqu'à 26.0 mm  
sans boîte  
serie di 26 pezzi (grandezza intera)  
da 1.0 fino a 26.0 mm  
senza scatola

Gynäkologie . Gynecologie . Ginecologia  
Uterusdilatoren  
Uterine Dilators  
Dilatadores uterinos  
Dilatateurs du col de l'utérus  
Dilatatori uterini



Hegar

Hegar  
MAB 21-158  
Satz mit 8 Stück  
von 3.0 / 4.0 bis 17.0 / 18.0 mm  
ohne Etui  
set of 8 pieces  
from 3.0 / 4.0 to 17.0 / 18.0 mm  
without case  
juego de 8 piezas  
de 3.0 / 4.0 a 17.0 / 18.0 mm  
sin caja  
jeu de 8 pièces  
de 3.0 / 4.0 jusqu'à 17.0 / 18.0 mm  
sans boîte  
serie di 8 pezzi  
da 3.0 / 4.0 fino a 17.0 / 18.0 mm  
senza scatola

1.0 / 2.0	MAB 21-145
3.0 / 4.0	MAB 21-146
5.0 / 6.0	MAB 21-147
7.0 / 8.0	MAB 21-148
9.0 / 10.0	MAB 21-149
11.0 / 12.0	MAB 21-150
13.0 / 14.0	MAB 21-151
15.0 / 16.0	MAB 21-152
17.0 / 18.0	MAB 21-153
19.0 / 20.0	MAB 21-154
21.0 / 22.0	MAB 21-155
23.0 / 24.0	MAB 21-156
25.0 / 26.0	MAB 21-157

Gynäkologie . Gynecology . Ginecologia  
Uterusdilatoren  
Uterine Dilators  
Dilatadores uterinos  
Dilatateurs du col de l'utérus  
Dilatatori uterini



Hegar

MAB 21-159  
Satz mit 8 Stück  
von 3.0 / 4.0 bis 17.0 / 18.0 mm  
in auskochbarer Stoffrolle  
set of 8 pieces  
from 3.0 / 4.0 to 17.0 / 18.0 mm  
in boilable canvas roll  
juego de 8 piezas  
de 3.0 / 4.0 a 17.0 / 18.0 mm  
en bolsa de tela esterilizable por ebullición  
jeu de 8 pièces  
de 3.0 / 4.0 jusqu'à 17.0 / 18.0 mm  
en pochette en treillis stérilisable par ébullition  
serie di 8 pezzi  
da 3.0 / 4.0 jusqu'à 17.0 / 18.0 mm  
in busta di tela sterilizzabile



Hegar

MAB 21-160  
Satz mit 8 Stück  
von 3.0 / 4.0 bis 17.0 / 18.0 mm  
in Metalletui mit Scharnierdeckel  
set of 8 pieces  
from 3.0 / 4.0 to 17.0 / 18.0 mm  
in metal case with hinged lid  
juego de 8 piezas  
de 3.0 / 4.0 a 17.0 / 18.0 mm  
en caja metálica con tapa de bisagra  
jeu de 8 pièces  
de 3.0 / 4.0 jusqu'à 17.0 / 18.0 mm  
en boîte métal à charnière  
serie di 8 pezzi  
da 3.0 / 4.0 fino a 17.0 / 18.0 mm  
in scatola metallica con coperchio a cerniera



Gynäkologie . Gynécologie . Ginecologia  
 Uterusdilatatoren  
 Uterine Dilators  
 Dilataores uterinos  
 Dilatateurs du col de l'utérus  
 Dilatatori uterini

amerikanische Skala  
 American scale  
 escala americana  
 échelle américaine  
 scala americana

- MAB 21-161 Fig. 9/10 4.5 / 5.0 mm Ø
- MAB 21-162 Fig. 11/12 5.5 / 6.0 mm Ø
- MAB 21-163 Fig. 13/14 6.5 / 7.0 mm Ø
- MAB 21-164 Fig. 15/16 7.5 / 8.0 mm Ø
- MAB 21-165 Fig. 17/18 8.5 / 9.0 mm Ø
- MAB 21-166 Fig. 19/20 9.5 / 10.0 mm Ø



Hank

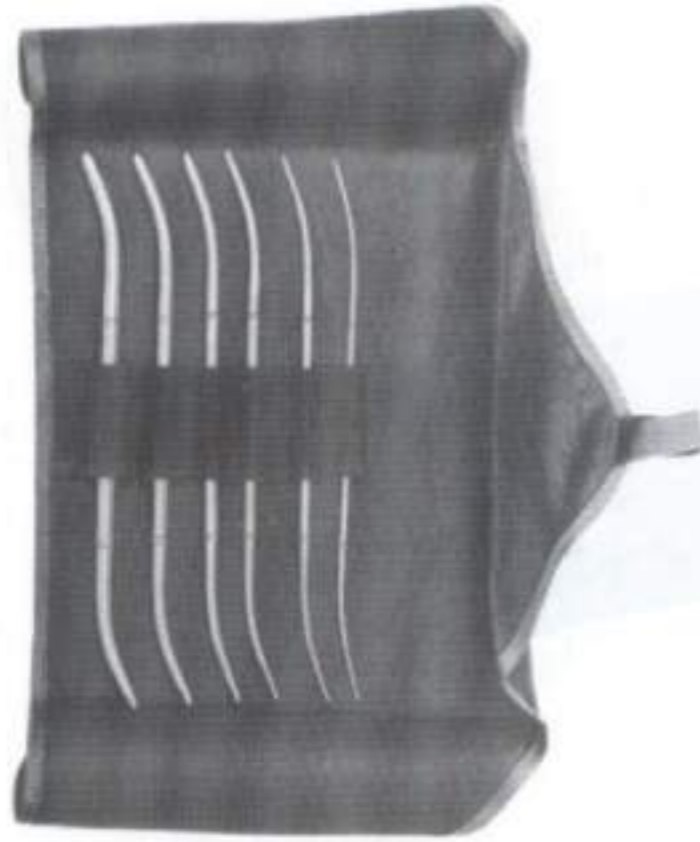

**Hank**  
 Satz mit 6 Stück  
 in auskochbarer Stoffrolltasche  
 set of 6 piezas  
 in boilable canvas roll  
 juego de 6 piezas  
 en bolsa de tela esterilizable por ebullición  
 jeu de 6 pièces  
 en pochette en treillis stérilisable par ébullition  
 serie di 6 pezzi  
 in busta di tela sterilizzabile

Gynäkologie . Gynecology . Ginecologia  
 Uterussonden, Uterusdepressor  
 Uterine Sounds, Uterine Depressor  
 Histerómetros, Depresor uterino  
 Hystéromètres, Dépresseur utérin  
 Isterometri, Depressore uterino



Sims  
 MAB21-167  
 33 cm / 13"  
 fest  
 rigid  
 rigido  
 rigido

Sims  
 MAB21-168  
 33 cm / 13"  
 biegsam  
 malleable  
 maleable  
 malléable  
 malleabile

Valleix  
 MAB21-169  
 29.5 cm / 11 1/2"

Braun  
 MAB21-170  
 27.5 cm / 10 1/4"

Gynäkologie . Gynécologie . Ginecologia  
 Hakenzangen, Amniotom  
 Uterine Tenaculum Forceps, Amniotome  
 Pinza para cuello uterino, Amniótome  
 Pince pour le col de l'utérus, Amniotome  
 Pinza per il collo dell' utero, Amniotomo

Gynäkologie . Gynecology . Ginecologia  
 Hakenzangen  
 Uterine Tenaculum Forceps  
 Pinza para cuello uterino  
 Pince pour le col de l'utérus  
 Pinza per il collo dell' utero



Schröder  
 MAB21-171  
 25.5 cm / 10"

Braun  
 MAB21-172  
 26 cm / 10 1/4"

Duplay  
 MAB21-173  
 25.5 cm / 10"

Beacham  
 MAB21-174  
 26 cm / 10 1/4"  
 Amniotom  
 Amniotome  
 Amniótomo  
 Amniotome  
 Amniotomo



Skene  
 MAB21-175  
 24 cm / 9 1/2"

MAB21-176  
 25 cm / 9 3/4"

MAB21-177  
 23.5 cm / 9 1/4"

Teale  
 MAB21-178  
 23.5 cm / 9 1/4"



Iowa

Museux

Jacobs

Gynäkologie . Gynécologie . Ginecologia  
 Hakenzangen  
 Uterine Tenaculum Forceps  
 Pinza para cuello uterino  
 Pince pour le col de l'utérus  
 Pinza per il collo dell' utero

6 mm  
 MAB21-180  
 24 cm / 9 1/2"

8 mm  
 MAB21-181  
 24 cm / 9 1/2"

10 mm  
 MAB21-182  
 24 cm / 9 1/2"

MAB21-183  
 21 cm / 8 1/4"



Gynäkologie . Gynecology . Ginecología  
**Hakenzangen**  
**Uterine Tenaculum Forceps**  
**Pinza para cuello uterino**  
**Pince pour le col de l'utérus**  
**Pinza per il collo dell'utero**

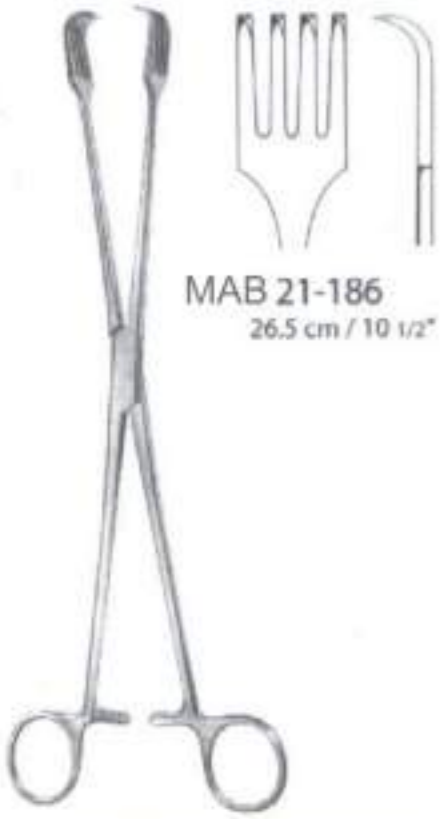

MAB 21-186  
26.5 cm / 10 1/2"



MAB 21-184  
16 cm / 6 1/4"

Braun



MAB 21-185  
21 cm / 8 1/4"

Czerny

Gynäkologie . Gynecology . Ginecología  
**Uterus-Polypenzangen**  
**Uterine Polypus Forceps**  
**Pinzas para pólipos uterinos**  
**Pinces à polypes utérins**  
**Pinze per polipi uterini**

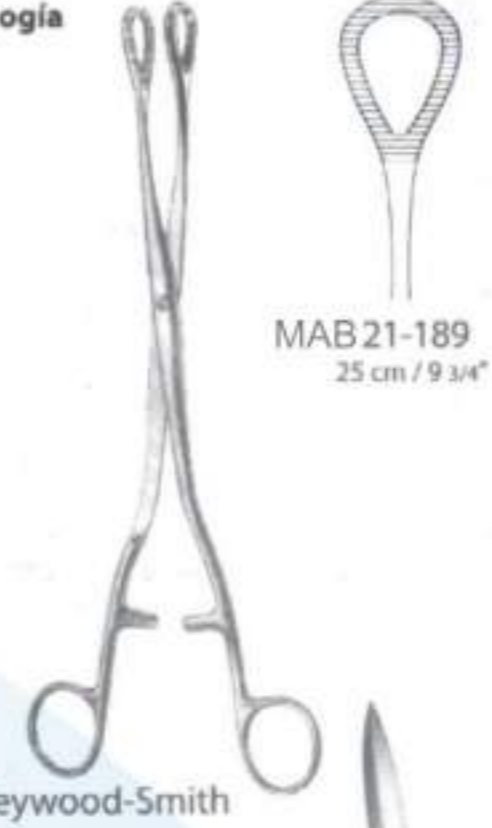

MAB 21-189  
25 cm / 9 3/4"

Heywood-Smith

Gynäkologie . Gynecologie . Ginecologia  
**Uterus-Polypenzangen**  
**Uterine Polypus Forceps**  
**Pinzas para pólipos uterinos**  
**Pinces à polypes utérins**  
**Pinze per polipi uterini**



MAB 21-187  
32 cm / 12 1/2"

Kelly



MAB 21-188  
27 cm / 10 3/4"

Noto

Gynäkologie . Gynecologie . Ginecologia  
**Myomheber, Myommesser**  
**Myoma Screws, Myoma Knife**  
**Tirabuzones para fibroma, Cuchillo para fibroma**  
**Tracteurs pour fibromes, Evideur de fibromes**  
**Tiramioni, Bisturi per fibromi**



Doyen  
MAB 21-190  
17 cm / 6 3/4"  
Spirale  
spiral  
espiral  
spirale  
spirale  
14 mm Ø

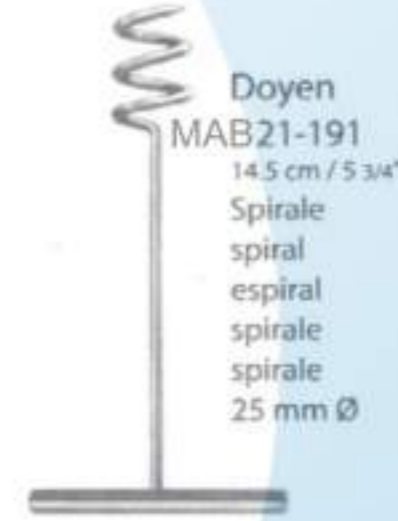

Doyen  
MAB 21-191  
14.5 cm / 5 3/4"  
Spirale  
spiral  
espiral  
spirale  
spirale  
25 mm Ø



MAB 21-192  
25 cm / 9 3/4"  
Schneide 13 mm breit  
cutting edge 13 mm wide  
hoja cortante 13 mm de ancho  
tranchant largeur 13 mm  
filo larghezza 13 mm

Segond

Gynäkologie . Gynecology . Ginecologia  
**Uterusfassange**  
**Uterine Seizing Forceps**  
**Histerólabos**  
**Pinces hystérolabes**  
**pinze isterolabi**



Dartigues  
MAB 21-193  
28 cm / 11"  
Maul 32 mm breit  
jaw 32 mm wide  
boca 32 mm de ancho  
mors largeur 32 mm  
morso larghezza 32 mm



Somer  
MAB 21-194  
22.5 cm / 8 3/4"  
Maul 32 mm breit  
jaw 32 mm wide  
boca 32 mm de ancho  
mors largeur 32 mm  
morso larghezza 32 mm



Collin  
MAB 21-195  
26 cm / 10 1/4"  
Maul 40 mm breit  
jaw 40 mm wide  
boca 40 mm de ancho  
mors largeur 32 mm  
morso larghezza 32 mm

Gynäkologie . Gynecologie . Ginecologia  
**Fistelhaken**  
**Fistula Hooks**  
**Ganchos para fistulas**  
**Crochets pour fistules**  
**Uncini per fistole**



MAB 21-196  
23.5 cm / 9 1/4"  
Schneide 6.3 mm breit  
cutting edge 6.3 mm wide  
hoja cortante 6.3 mm de ancho  
tranchant largeur 6.3 mm  
tilo larghezza 6.3 mm

Ayre  
Konusmesser  
Conization Knife  
Bisturi para cono  
Bistouri pour le cône d'attraction  
Bisturi per il cono d'attrazione

Gynäkologie . Gynecology . Ginecologia  
**Saugküretten, Biopsieküretten**  
**Suction Curettes, Uterine Biopsy Curettes**  
**Curetas aspiradoras, Curetas para biopsia**  
**Curettes à aspiration, Curettes pour biopsia**  
**Curette d'aspirazione, Curette per biopsia**

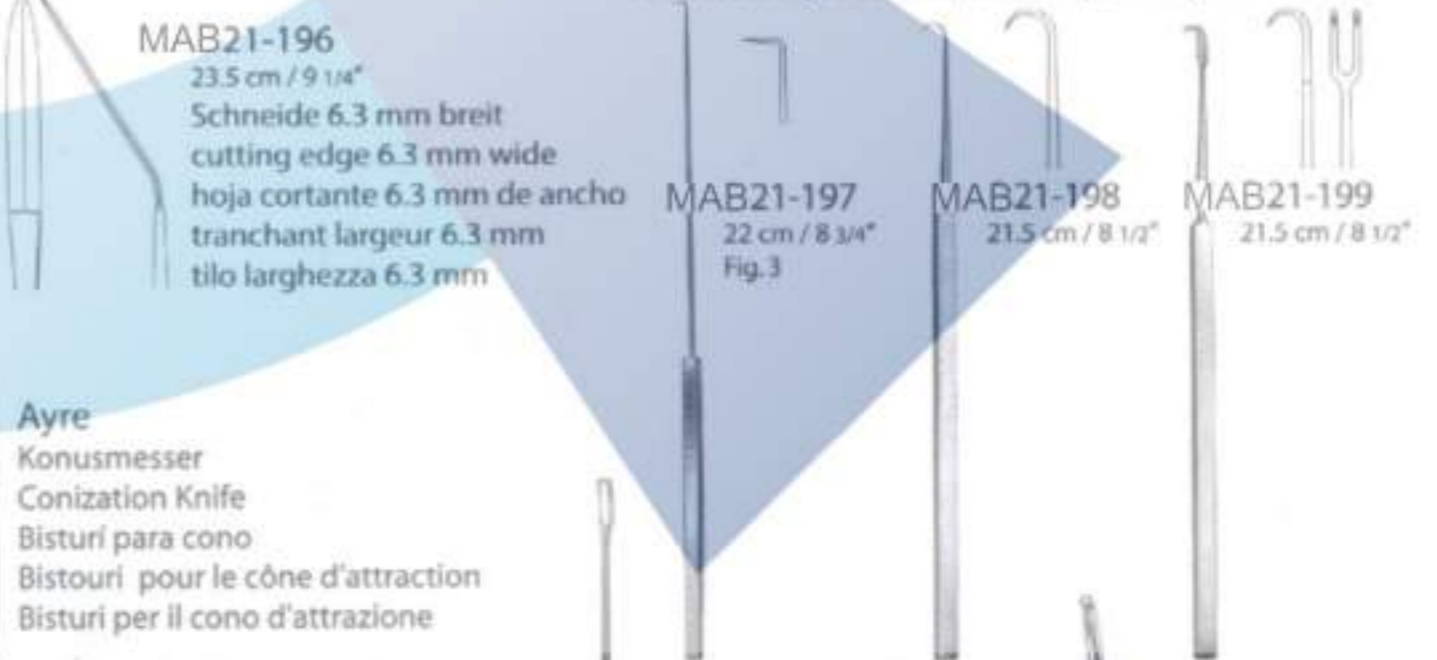

MAB 21-197  
22 cm / 8 3/4"  
Fig. 3

MAB 21-198  
21.5 cm / 8 1/2"

MAB 21-199  
21.5 cm / 8 1/2"

Emmett

Simon

Simon



MAB 21-200  
24.5 cm / 9 3/4"  
4.0 mm Ø

Novak  
mit Luer-Lock Ansatz  
with Luer-Lock connection  
con conexión Luer-Lock  
avec connection Luer-Lock  
con raccordo Luer-Lock



MAB 21-201  
30 cm / 11 3/4"  
6.0 mm Ø

Kevorkain



MAB 21-202  
27 cm / 10 3/4"  
4.8 mm Ø

München



Gynäkologie . Gynécologie . Ginecologia  
 Probeexzisionszangen  
 Uterine Biopsy Forceps  
 Pinzas para biopsia  
 Pincas pour biopsie  
 Pinze per biopsia

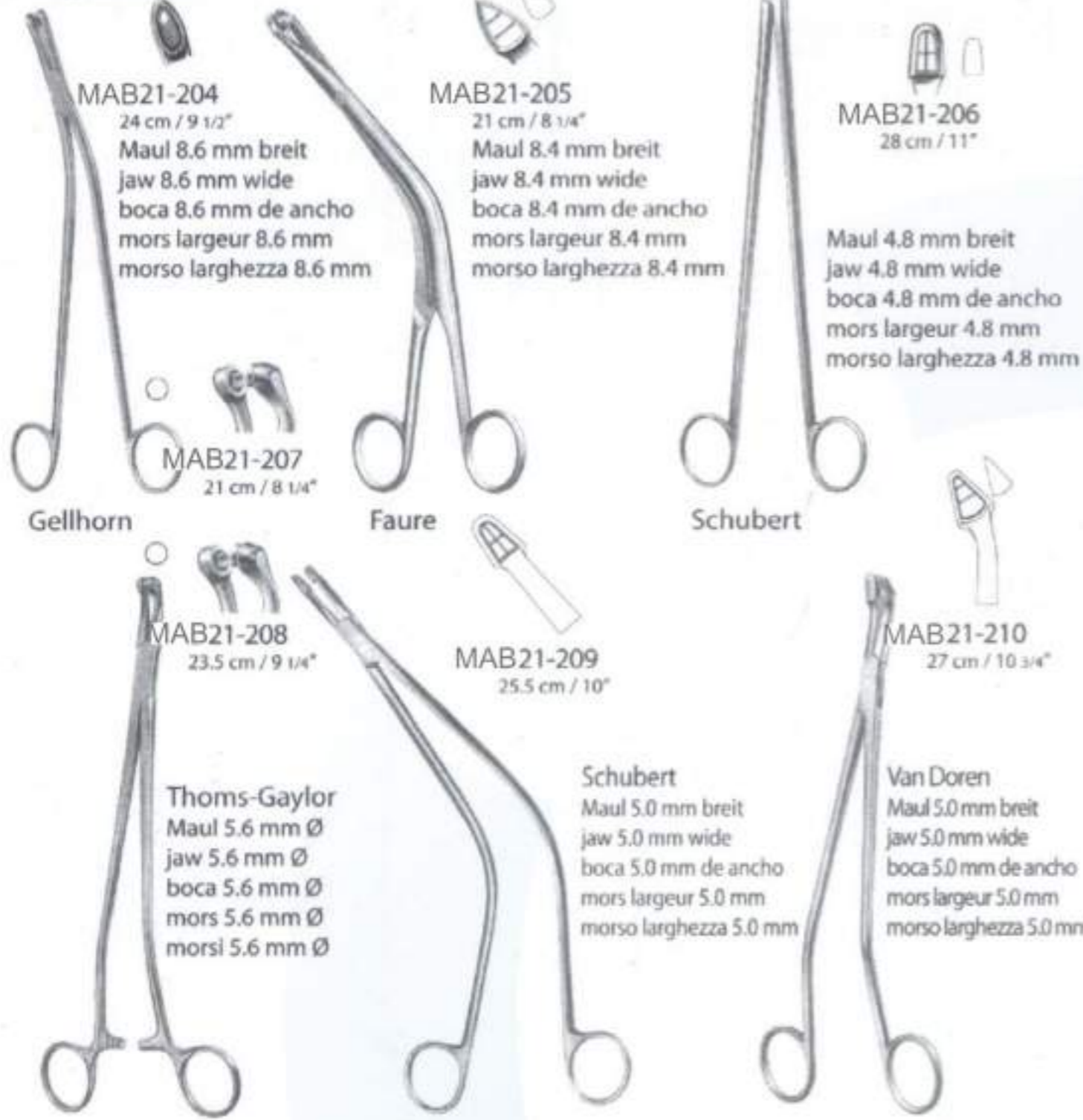

Gynäkologie . Gynécologie . Ginecologia  
 Probeexzisionszangen  
 Uterine Biopsy Forceps  
 Pinzas para biopsia  
 Pincas pour biopsie  
 Pinze per biopsia

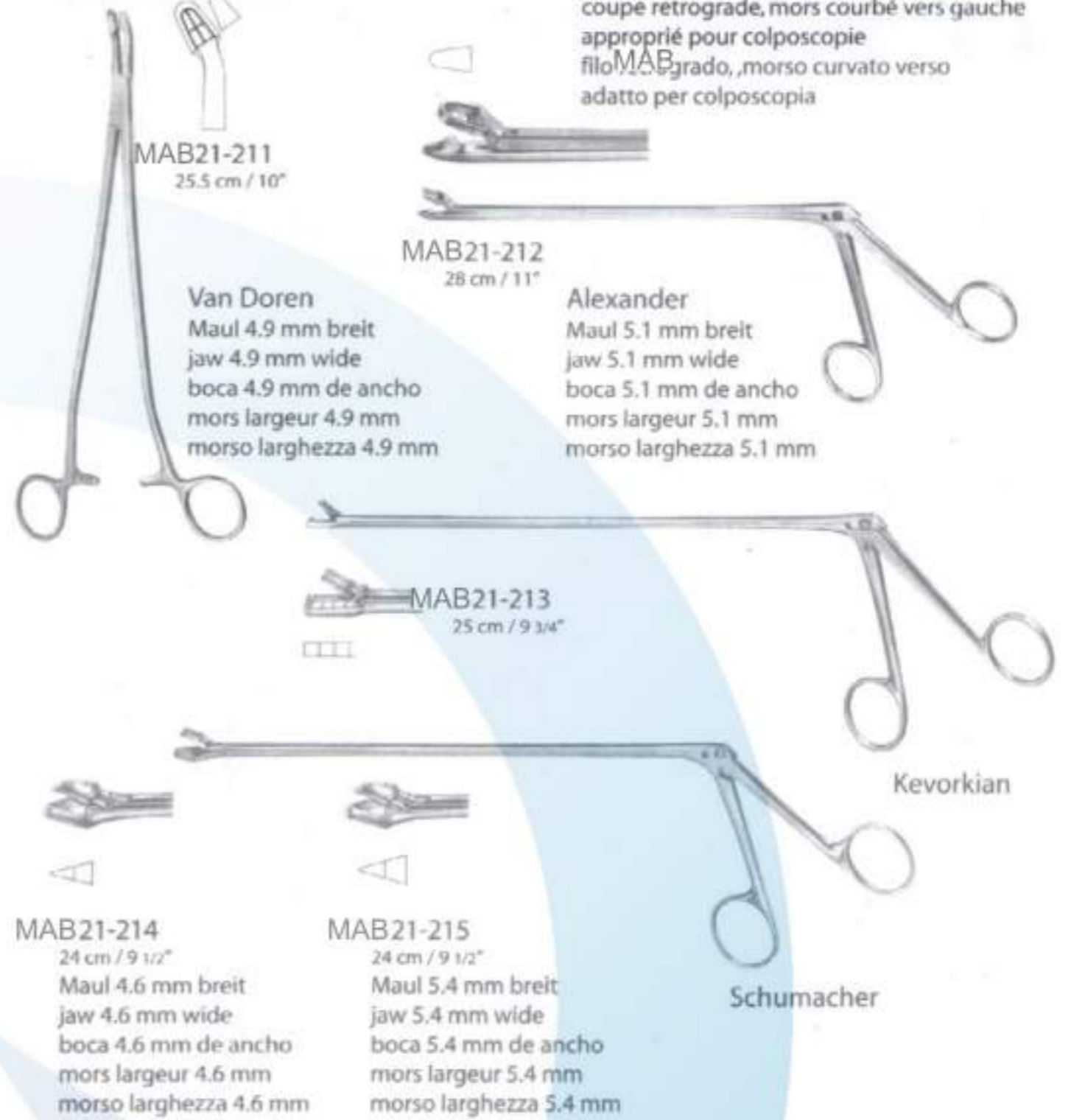

retrograder Schnitt, Maul nach links gebogen  
 geeignet für Kolposkopie  
 retrograde cutting, jaws curved to left  
 suitable also in colposcopy  
 corte retrograde, boca curva hacia izquierda  
 utilisable en colposcopia  
 coupe retrograde, mors courbé vers gauche  
 approprié pour colposcopie  
 filoMABgrado, morso curvato verso  
 adatto per colposcopia

Gynäkologie . Gynécologie . Ginecologia  
 Probeexzisionszangen, IUP-Fasszangen  
 Uterine Biopsy Forceps, IUP Grasping Forceps  
 Pinza para biopsia, Pinzas para coger DIU  
 Pince pour biopsie, Pincas-DIU  
 Pinze per biopsia, Pinze intra-uterine

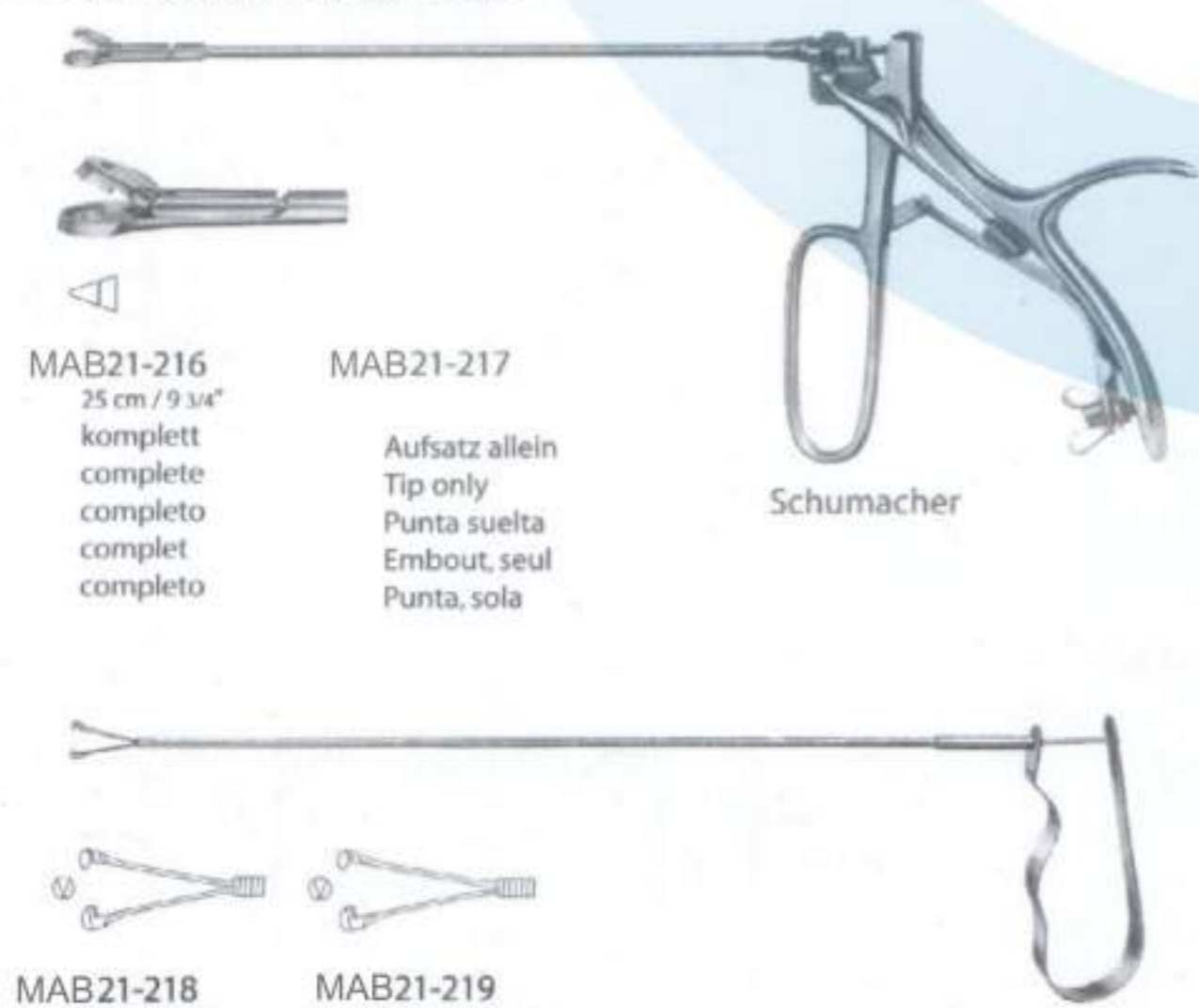

flexibler Schaft  
 zum Fassen von Intrauterinpressaren  
 flexible shaft  
 for grasping intra uterine pessary  
 vástago flexible  
 para coger dispositivos intra-uterinos  
 tige flexible  
 pour saisir dispositif intra-utérin  
 asta flessibile  
 per afferare dispositivo intra-uterino

Gynäkologie . Gynecology . Ginecologia  
 Uterusöffel  
 Uterine Scoops  
 Cucharillas uterinas  
 Curettes utérines  
 Curette uterine



Simon  
 scharf, fest  
 sharp, rigid  
 cortante, rigido  
 tranchante, rigide  
 tagliente, rigido

Simon  
 scharf, fest  
 sharp, rigid  
 cortante, rigido  
 tranchante, rigide  
 tagliente, rigido



Gynäkologie . Gynécologie . Ginecologia  
 Uterusküretten  
 Uterine Curettes  
 Curetas uterinas  
 Curettes utérines  
 Curette uterine



Fig.	Breite width anchura largeur larghezza	scharf, fest sharp, rigid	scharf, biegsam sharp, malleable	stumpf, fest blunt, rigid	stumpf, biegsam blunt, malleable
		cortante, rigido	cortante, malleable	romo, rigido	romo, malleable
		tranchante, rigido	tranchante, malleable	mousse, rigido	mousse, malleable
		tagliente, rigido	tagliente, malleabile	smusso, rigido	smusso, malleabile

00	5 mm	MAB21-240	MAB21-258	MAB21-276	MAB21-294
0	6 mm	MAB21-241	MAB21-259	MAB21-277	MAB21-295
1	7 mm	MAB21-242	MAB21-260	MAB21-278	MAB21-296
2	8 mm	MAB21-243	MAB21-261	MAB21-279	MAB21-297
3	9 mm	MAB21-244	MAB21-262	MAB21-280	MAB21-298
4	11 mm	MAB21-245	MAB21-263	MAB21-281	MAB21-299
5	12 mm	MAB21-246	MAB21-264	MAB21-282	MAB21-300
6	14 mm	MAB21-247	MAB21-265	MAB21-283	MAB21-301
7	15 mm	MAB21-248	MAB21-266	MAB21-284	MAB21-302
8	16 mm	MAB21-249	MAB21-267	MAB21-285	MAB21-303
9	19 mm	MAB21-250	MAB21-268	MAB21-286	MAB21-304
10	20 mm	MAB21-251	MAB21-269	MAB21-287	MAB21-305
11	21 mm	MAB21-252	MAB21-270	MAB21-288	MAB21-306
12	23 mm	MAB21-253	MAB21-271	MAB21-289	MAB21-307
13	25 mm	MAB21-254	MAB21-272	MAB21-290	MAB21-308
14	30 mm	MAB21-255	MAB21-273	MAB21-291	MAB21-309
15	35 mm	MAB21-256	MAB21-274	MAB21-292	MAB21-310
16	40 mm	MAB21-257	MAB21-275	MAB21-293	MAB21-311

Gynäkologie . Gynecology . Ginecologia  
 Uterusküretten  
 Uterine Curettes  
 Curetas uterinas  
 Curettes utérines  
 Curette uterine



Gynäkologie . Gynécologie . Ginecologia  
 Absaugküretten  
 Suction Curettes  
 Curetas aspiradoras  
 Curettes d'aspiration  
 Curette per aspirazione



MAB-313	MAB-314	MAB-315	MAB-316	MAB-317	MAB-318	MAB-319
29 cm / 11 1/2"	29 cm / 11 1/2"	29 cm / 11 1/2"	29 cm / 11 1/2"	29 cm / 11 1/2"	29 cm / 11 1/2"	29 cm / 11 1/2"
3.0 mm Ø	4.5 mm Ø	6.0 mm Ø	8.0 mm Ø	9.0 mm Ø	12.0 mm Ø	14.0 mm Ø

MAB-312  
 12 cm / 4 3/4"  
 Kupplungsstück  
 Coupling Piece  
 Pieza de acoplamiento  
 Pièce de raccordement  
 Pezzo di collegamento

## MAB 22

Geburtshilfe  
 Obstetrics  
 Obstetricia  
 Obstetrica  
 Ostetricia

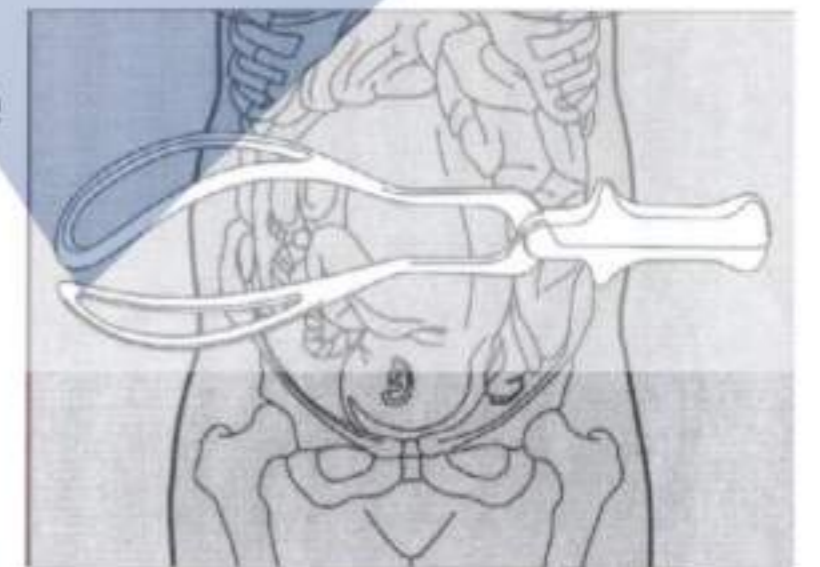



Geburtshilfe . Obstetrics . Obstetricia  
 Beckenzirkel, Geburtszangen  
 Pelvimeter, Obstetrical Forceps  
 Pelvimetro, Forceps obstétricos  
 Pelvimètre, Forceps obstétriques  
 Pelvimetri, Forcipi obstetrici



**Martin**  
 MAB 22-001  
 34 cm / 13 1/2"  
 cm / inch Skala  
 cm / inch scale  
 escala en cm / pulgadas  
 échelle en cm / pouces  
 scala in cm / pollici

Geburtshilfe . Obstétrique . Ostetricia  
 Abortuszangen  
 Placenta and Ovum Forceps  
 Pinzas para aborto  
 Pincas placentaires et pour poste-abortum  
 Pinze per placenta e per ovaie



**Green-Armytage**  
 klemmzange  
 Uterine Clamp  
 Pinza uterina para hemostasis  
 Pince utérine pour hémostase  
 Pinza emostatica per tagli cesarei



**Sellheim**  
 Geburtslöffel  
 Obstetrical Lever  
 Elevador obstetrico  
 Levier obstétrique  
 Leva ostetrica



**Nägele**  
 MAB22-002  
 35 cm / 13 3/4"



**Simpson**  
 MAB22-004  
 31 cm / 12 1/2"



**Wrigley**  
 MAB 22-005  
 28 cm / 11"



**Simpson**  
 MAB22-006  
 36.5 cm / 14 1/4"



**Kielland**  
 MAB22-007  
 42 cm / 16 1/2"

**MAB22-003**  
 40.5 cm / 16"



**Sänger**



**MAB22-010**  
 27.5 cm / 10 3/4"



**MAB22-011**  
 27 cm / 10 3/4"



**Winter**



**MAB22-013**  
 28 cm / 11"  
 Fig. 1



**MAB22-013**  
 28 cm / 11"  
 Fig. 2



**MAB22-014**  
 28 cm / 11"  
 Fig. 1



**MAB22-015**  
 28 cm / 11"  
 Fig. 2

Geburtsnare . Obstetrics . Obstetricia  
 Abortuslöffel, Nabelschnurklemmen  
 Placenta Scoops, Umbilical Cord Clamps  
 Cucharillas para aborto, Clamps umbilicales  
 Curettes a avortement et placenta, Clamps ombilicaux  
 Cucchiari per placenta e ovaie, Clamps ombelicali

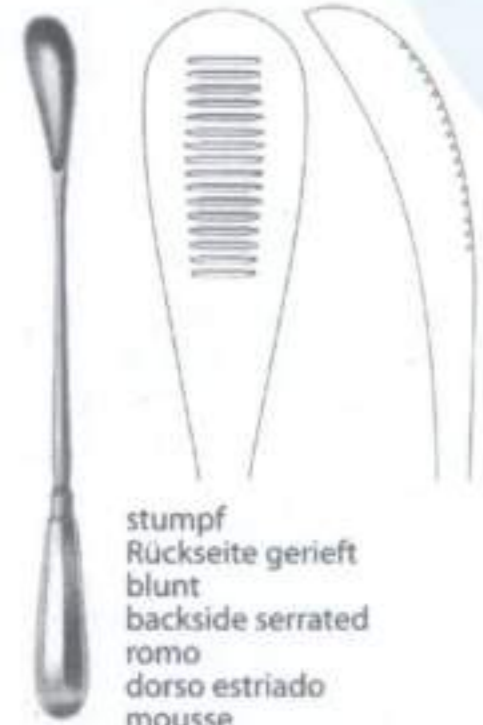

**Cuzzi**  
 stumpf  
 Rückseite gerieft  
 blunt  
 backside serrated  
 romo  
 dorso estriado  
 mousse  
 dos estrié  
 smusso  
 dorso scanalato



**MAB22-016**  
 30 cm / 11 3/4"  
 14.5 mm



**MAB 22-017**  
 30 cm / 11 3/4"  
 18 mm



**MAB22-018**  
 30 cm / 11 3/4"  
 20 mm

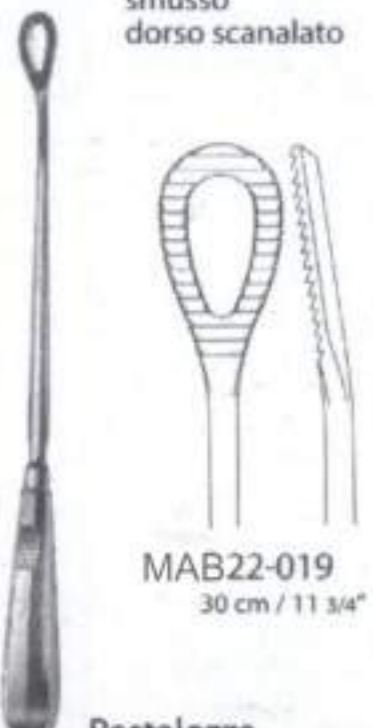

**Pestalozza**

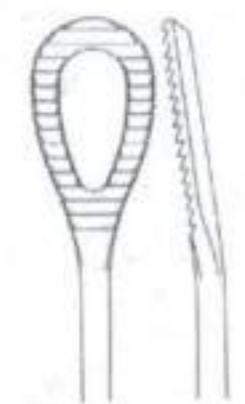

**MAB22-019**  
 30 cm / 11 3/4"



**Kane**

**MAB22-020**  
 8.5 cm / 3 1/4"



**Collin**

**MAB22-021**  
 8.5 cm / 3 1/4"

## MAB 23

Messzirkel  
 Calipers  
 Compases  
 Compas  
 Compassi





Messzirkel . Callipers . Compases  
 Messzirkel  
 Calipers  
 Compases  
 Compas  
 Compassi



## MAB 24

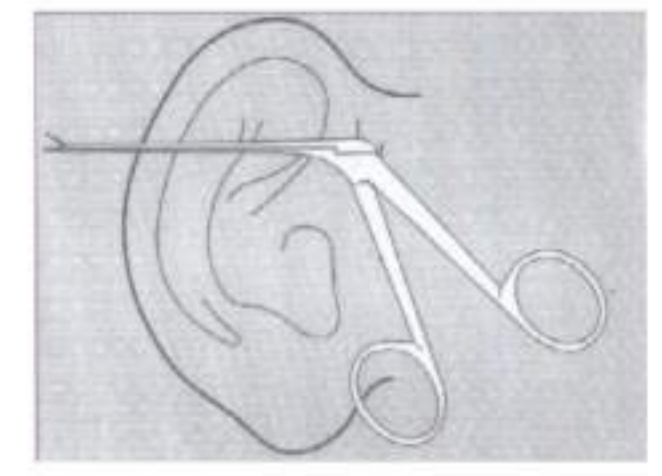

Otologie  
 Otology  
 Otologia  
 Otologie  
 Otologia

Otologie . Otology . Otologia  
 Mikro-Ohrzängchen  
 Micro Ear Forceps  
 Micro Pinzas auriculares  
 Micro Pinces auriculaires  
 Micro Pinze auricolari

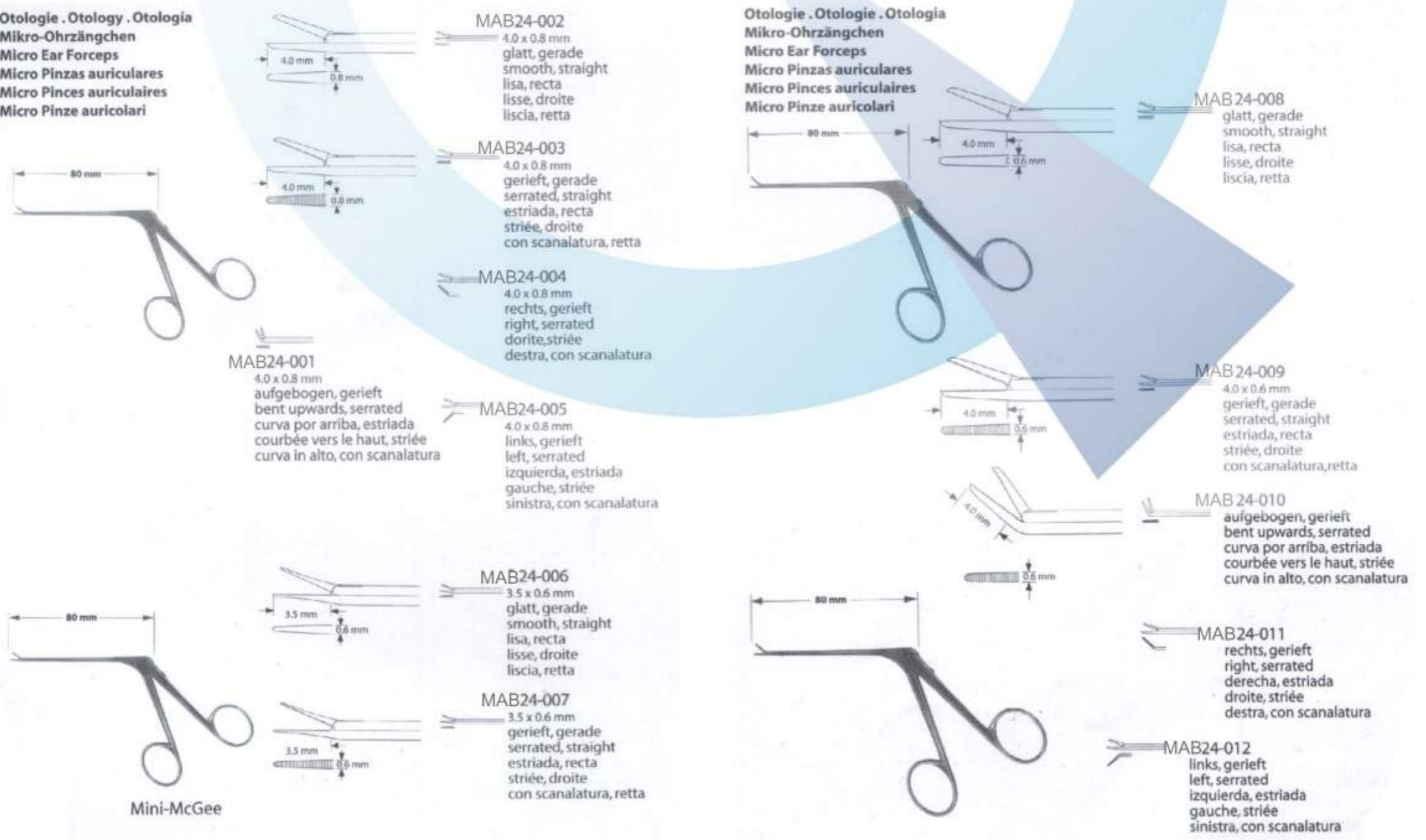



Otologie . Otology . Otologia  
Mikro-Ohrzängchen  
Micro Ear Forceps  
Micro Pinzas auriculares  
Micro Pinces auriculaires  
Micro Pinze auricolari

MAB24-015  
4.0 mm  
gerade  
straight  
recta  
droite  
retta

Löffel  
cup  
cucharilla  
curette  
cucchiaio  
1.0 x 0.9 mm

MAB24-016  
4.0 mm  
aufgebogen  
bent upwards  
curva por arriba  
courbée en haut  
curva in alto

MAB24-017  
4.0 mm  
links  
left  
izquierda  
gauche  
sinistra

MAB24-013  
4.0 mm  
rechts  
right  
derecha  
droite  
destra

MAB24-018  
3.5 mm  
gerade  
straight  
recta  
droite  
retta

Löffel  
cup  
cucharilla  
curette  
cucchiaio  
0.6 x 0.5 mm

MAB24-019  
3.5 mm  
aufgebogen  
bent upwards  
curva por arriba  
courbée en haut  
curva in alto

MAB24-020  
3.5 mm  
links  
left  
izquierda  
gauche  
sinistra

MAB24-014  
3.5 mm  
rechts  
right  
recta  
droite  
destra

Otologie . Otologie . Otologia  
Mikro-Ohrschere  
Micro Ear Scissors  
Micro tijeras auriculares  
Micro Ciseaux auriculaires  
Micro Forbici auricolari

MAB24-021  
rechts  
right  
derecha  
droite  
destra

sehr fein  
very fine  
muy fina  
très fine  
molto delicata

MAB24-022  
rechts  
right  
derecha  
droite  
destra

MAB24-023  
gerade  
straight  
recta  
droite  
retta

MAB24-024  
aufgebogen  
bent upwards  
curva por arriba  
courbée vers le haut  
curva in alto

MAB24-025  
links  
left  
izquierda  
gauche  
sinistra

MAB24-026  
gerade  
straight  
recta  
droite  
retta

MAB24-027  
aufgebogen  
bent upwards  
curva por arriba  
courbée vers le haut  
curva in alto

S 24-028  
links  
left  
izquierda  
gauche  
sinistra

Bellucci

Wullstein

Otologie . Otology . Otologia  
Mikro-Ohrzängchen  
Micro Ear Forceps  
Micro pinzas auriculares  
Micro Pinces auriculaires  
Micro Pinze auricolari

MAB24-029  
0.8 x 3.5 mm  
abgebogen  
bent downwards  
curva por abajo  
courbée vers le bas  
curva in basso

MAB24-030  
0.8 x 6.0 mm  
abgebogen  
bent downwards  
curva por abajo  
courbée vers le bas  
curva in basso

MAB24-031

MAB24-032

oben schneidend  
up-cutting  
corte arriba  
tranchante en haut  
tagliante in alto

unten schneidend  
down-cutting  
corte abajo  
tranchante en bas  
tagliante in basso

MAB24-033

MAB24-034

MAB24-035

McGee  
Drahtbiegezängchen  
Wire Bending Forceps  
Pinza para plegar alambre  
Pince à plier les fils d'acier  
Pinza per piegare fili metallici

House-Dieter  
Hammerkopfzängchen  
Malleus Nipper  
Pinza para cabezal del maléolo  
Pince pour l'os marteau  
Pinza per testa del matelletto

House-Dieter  
Hammerkopfzängchen  
Malleus Nipper  
Pinza para cabezal del maléolo  
Pince pour l'os marteau  
Pinza per testa del matelletto

Fuller  
Einführungszängchen  
Introducing Forceps  
Pinza para introducir  
Pince pour introduction  
Pinza per introduzione

Otologie . Otologie . Otologia  
Mikro-Ohrmesser  
Micro Ear Knives  
Micro cuchillos auriculares  
Micro Couteaux auriculaires  
Micro Coltelli

MAB24-036

MAB24-037  
14.5 cm / 5 3/4"

MAB24-038  
15.5 cm / 6"

MAB24-039

MAB24-040  
15 cm / 6"

Schuknecht  
Rollenmesser  
Rotary Knife  
Cuchillo redondo  
Couteau à roulette  
Coltello rotondo

Schuknecht  
Sichelmesser  
Sickle knife  
Cuchillos de hoz  
Synéchiotome  
Coltello falcato  
come sinechia

Wullstein  
Sichelmesser  
Sickle knife  
Cuchillos de hoz  
Synéchiotome  
Coltello falcato  
come sinechia

Tabb  
schleimhautmesser  
Mucosa Knife  
Cuchillo para mucosa  
Couteau pour muqueuse  
Bisturi per mucosa

Plester  
Lappenmesser  
Flap Knife  
Cuchillo para lóbulos  
Couteau lobaire  
Coltello per lobi

MAB24-041  
15 cm / 6"  
Fig. 1  
3 mm Ø

MAB24-042  
15 cm / 6"  
Fig. 2  
2.8 mm Ø

MAB24-043  
15 cm / 6"  
Fig. 3  
2.6 mm Ø

MAB24-044  
15 cm / 6"  
Fig. 4  
2 mm Ø

MAB24-045  
15 cm / 6"  
Fig. 5  
1.6 mm Ø

MAB24-046  
15 cm / 6"  
Fig. 6  
1.4 mm Ø

MAB24-047  
15 cm / 6"  
Fig. 7  
1.0 mm Ø

Rosen  
Rundschnittmesser  
Circular Cut Knives  
Cuchillos para cortes redondos  
Couteaux circulaires  
Coltelli circolari



Otologie . Otology . Otologia  
 Mikro-Ohrnadeln  
 Micro Ear Needles  
 Micro agujas auriculares  
 Micro Aiguilles auriculaires  
 Micro Aghi auricolari

Barbara MAB24-048 16 cm / 6 1/4"  
 Barbara MAB24-049 16 cm / 6 1/4"  
 Barbara MAB24-050 16 cm / 6 1/4"  
 Rosen MAB24-051 16 cm / 6 1/4"

MAB24-052 = 0.3 mm MAB24-055 = 0.3 mm MAB24-062 = 0.3 mm MAB24-069 = 0.5 mm  
 MAB24-053 = 0.6 mm MAB24-056 = 0.6 mm MAB24-063 = 0.6 mm MAB24-070 = 1.0 mm  
 MAB24-054 = 1.0 mm MAB24-057 = 1.0 mm MAB24-064 = 1.0 mm  
 MAB24-058 = 1.2 mm MAB24-065 = 1.2 mm  
 MAB24-059 = 1.5 mm MAB24-066 = 1.5 mm  
 MAB24-060 = 2.0 mm MAB24-067 = 2.0 mm  
 MAB24-061 = 2.5 mm MAB24-068 = 2.5 mm

Barbara 16 cm / 6 1/4"

Otologie . Otologie . Otologia  
 Mikro-Ohrhäkchen, Mikro-Ohrnadeln  
 Micro Ear Hooks, Micro Ear Needles  
 Micro ganchitos auriculares, Micro agujas auriculares  
 Micro Crochets auriculaires, Micro Aiguilles auriculaires  
 Micro Uncini auricolari, Micro Aghi auricolari

90° 15.5 cm / 6" MAB24-071 = 0.3 mm MAB24-074 = 0.3 mm  
 90° 15.5 cm / 6" MAB24-072 = 0.6 mm MAB24-075 = 0.6 mm  
 15.5 cm / 6" MAB24-073 = 1.0 mm MAB24-076 = 1.0 mm  
 15.5 cm / 6" MAB24-077 = 0.5 mm MAB24-078 = 1.0 mm  
 15.5 cm / 6" MAB24-079 = 0.5 mm MAB24-080 = 1.0 mm

McGee für Fußplatte for footplate para la platina estapediense pour la platine de l'étrier piedistallo  
 McGee für Fußplatte for footplate para la platina estapediense pour la platine de l'étrier piedistallo

Barbara MAB24-081 15.5 cm / 6"  
 Barbara MAB24-082 15.5 cm / 6"

Otologie . Otology . Otologia  
 Mikro-Ohrhäkchen  
 Micro Ear Hooks  
 Micro ganchitos auriculares  
 Micro crochets auriculaires  
 Micro Uncini auricolari

25° MAB24-083 0.3 mm  
 25° MAB24-084 0.6 mm  
 25° Shambaugh MAB24-085 1.0 mm  
 45° MAB24-086 0.3 mm  
 45° MAB24-087 0.6 mm  
 45° Shambaugh MAB24-088 1.0 mm

Otologie . Otologie . Otologia  
 Mikro-Dissektoren  
 Micro Dissectors  
 Micro dissecadores  
 Micro Dissecteurs  
 Micro Dissettori

MAB24-091 15.5 cm / 6" nach rechts abgewinkelt angled to right angulada por derecha coudée vers droite angulata a destra  
 MAB24-092 15.5 cm / 6" nach links abgewinkelt angled to left angulada por izquierda coudée vers gauche angulata a sinistra  
 MAB24-093 15.5 cm / 6" nach rechts abgewinkelt angled to right angulada por derecha coudée vers droite angulata a destra  
 MAB24-094 15.5 cm / 6" nach rechts abgewinkelt angled to left angulada por izquierda coudée vers gauche angulata a sinistra

Fisch

45° Shea MAB24-089 Sondierhaken Exploring Hook Ganchito explorador Crochet à exploration uncino di sondaggio 2.0 mm stumpf blunt romo mousse smusso

90° Austin MAB24-090 Attikusdissektor Attic Dissector Disecador para el ático Dissecteur pour l'attique Dissettore per l'attico 3.0 mm stumpf blunt romo mousse smusso

MAB24-095 15.5 cm / 6" Rosen Mikro-Ohrraspatorium Micro Ear Periosteal Elevator Micro legra auricular micro Rugine-Raspatoire auriculaire Micro Raspatore auricolare

MAB24-096 15.5 cm / 6" 3.5 mm House Mikro-Messsonde Micro Measuring Rod Micro sonda para medir Micro Sonde pour mesurer Micro Sonda per misurare  
 MAB24-097 15.5 cm / 6" 4.0 mm  
 MAB24-098 15.5 cm / 6" 4.5 mm  
 MAB24-099 15.5 cm / 6" 5.0 mm



Otologie . Otology . Otología  
 Mikro-Küretten  
 Micro Curettes  
 Micro cucharillas  
 Micro Curettes  
 Micro cucchiari

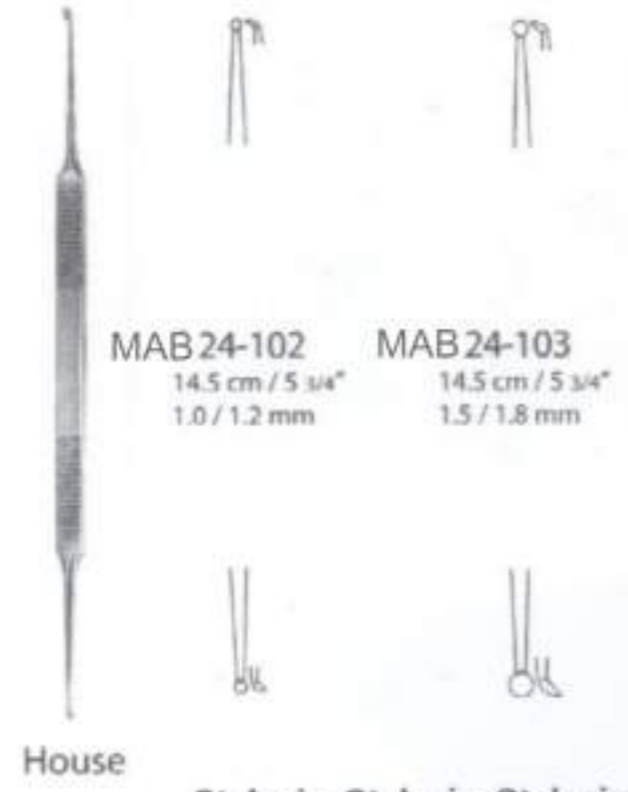
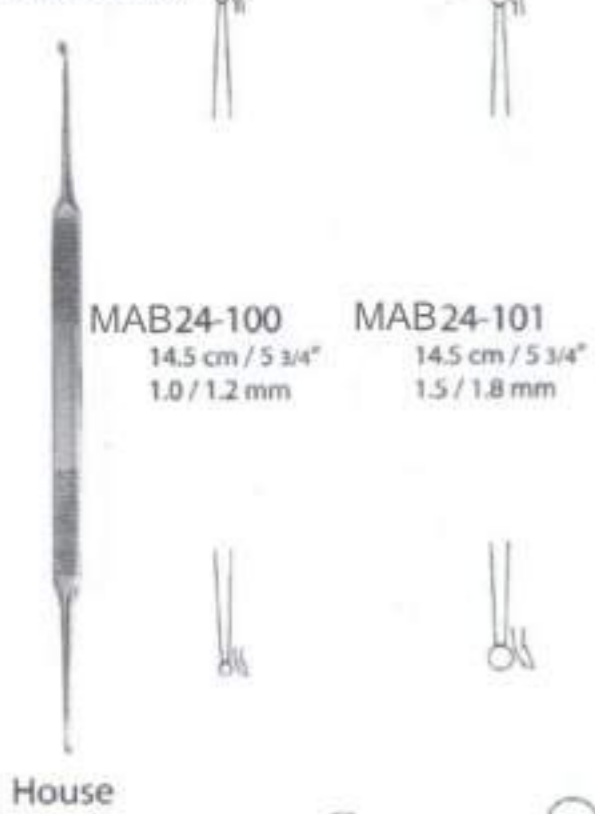

Otologie . Otologie . Otologia  
 Ohrspekula  
 Ear Specula  
 Espéculos auriculares  
 Spéculums auriculaires  
 Specoli auricolari



Ohrspekula, Satz  
 Ear Specula, set  
 Espéculos auriculares, juego  
 Spéculums auriculaires, jeu  
 Specoli auricolari, set  
 MAB24-124  
 bestehend aus 6 Stück  
 consisting of 6 pieces  
 consiste de 6 piezas  
 se composant de 6 pièces  
 composto di 6 pezzi

ohrspekula, Satz  
 Ear Specula, set  
 Espéculos auriculares, juego  
 Spéculums auriculaires, jeu  
 Specoli auricolari, set  
 MAB 24-125  
 MAB 24-126

für Erwachsene  
 for adults  
 para adultos  
 pour adultes  
 per adulti



ohrspekula, Satz  
 Ear Specula, set  
 Espéculos auriculares, juego  
 Spéculums auriculaires, jeu  
 Specoli auricolari, set  
 MAB24-111 Fig. 0 - 2

für Kinder  
 for children  
 para niños  
 pour enfants  
 per bambini  
 Ohrspekula, Satz  
 Ear Specula, set  
 Espéculos auriculares, juego  
 Spéculums auriculaires, jeu  
 Specoli auricolari, set  
 MAB24-112 Fig. 2 - 4  
 MAB24-113 Fig. 1 - 4

Zöllner  
 oval, schwarz  
 oval, black  
 ovalado, negro  
 ovale, noire  
 ovale, nero

Toynbee

Otologie . Otology . Otologia  
 Ohrspekula  
 Ear Specula  
 Espéculos auriculares  
 Spéculums auriculaires  
 Specoli auricolari

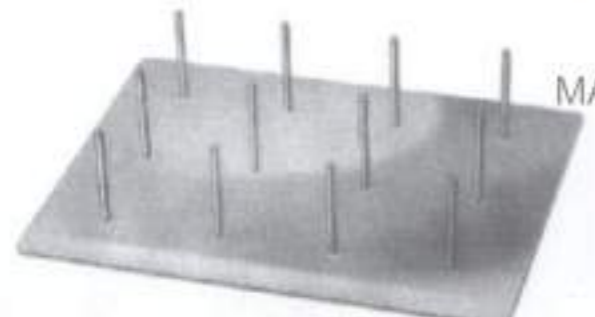

Otologie . Otology . Otologia  
 Stimmgabeln  
 Tuning Forks  
 Diapasones  
 Diapasons  
 Diapason





Otologie . Otologie . Otologia  
Stimmgabeln  
Tuning Forks  
Diapasones  
Diapasons  
Diapason



Lucae MAB24-151 c<sup>1</sup> 128  
Lucae MAB24-152 c<sup>1</sup> 256  
Lucae MAB24-153 c<sup>2</sup> 512  
Lucae MAB24-154 c<sup>3</sup> 1024  
Lucae MAB24-155 c<sup>4</sup> 2048  
Lucae MAB24-156 c<sup>5</sup> 4096

Otologie . Otology . Otologia  
Stimmgabeln  
Tuning Forks  
Diapasones  
Diapasons  
Diapason



**Rydel-Seiffert**  
MAB24-160  
C 64 / c 128  
auch für Neurologie  
also for Neurology  
para neurología  
aussi pour neurologie  
per neurologia  
mit Dämpfer = C64  
with dampers = C64  
con sordinas = C64  
avec curseurs = C64  
con sordine = C64  
ohne Dämpfer = c128  
without dampers = c128  
sin sordinas = c128  
sans curseurs c128  
senza sordine = c128

**Neuro**  
MAB24-161  
mit Hammer, Nadelrad, Pinsel u.  
Nadel  
with hammer, pinwheel, brush  
and needle  
con martillo, rueda con espinas,  
cepillo y aguja  
avec marteaux, roue aux  
épingles, broset et aiguille  
con martello, algesimetro,  
spazzola ed ago

**König**  
MAB24-162  
A 109  
verschiebbar bis g  
movable up to g  
regulable hasta g  
réglable jusqu'à g  
regolabile fino a g

MAB24-163  
a<sup>1</sup> 440

Aluminium



**MAB24-157**  
c 128  
verschiebbar bis h  
movable up to h  
regulable hasta h  
réglable jusqu'à h  
regolabile fino a h  
Lucae

**MAB24-158**  
c 128  
verschiebbar bis h  
movable up to h  
regulable hasta h  
réglable jusqu'à h  
regolabile fino a h  
Hartmann

**Hartmann**  
MAB24-159  
c<sup>1</sup> 256

Otologie . Otologie . Otologia  
Ohrkatheter, Polypenschürer  
Ear Catheters, Polypus Snare  
Sondas auriculares, Polipótomos  
Sondes auriculaires, Serre-noeuds  
Sonde auricolari, Serranodi

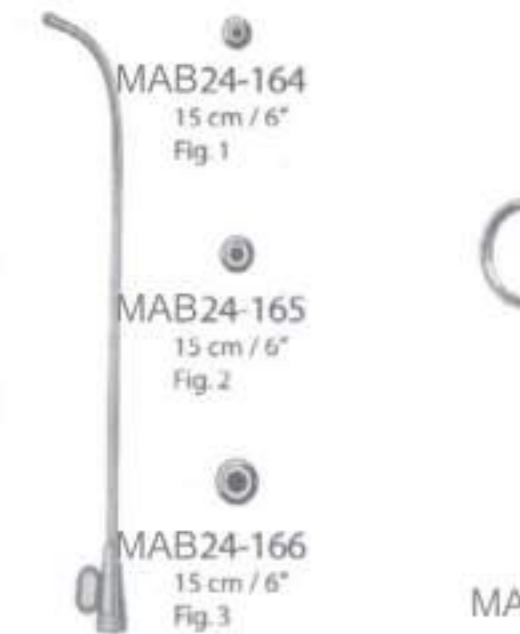

**MAB24-164**  
15 cm / 6"  
Fig. 1

**MAB24-165**  
15 cm / 6"  
Fig. 2

**MAB24-166**  
15 cm / 6"  
Fig. 3

Hartmann



**MAB24-167**  
18.5 cm / 7 1/4"  
offenes Ende  
open tip  
punta abierta  
pouente ouverte  
punta aperta

**MAB24-168**  
18.5 cm / 7 1/4"  
geschlossenes Ende  
closed tip  
punta cerrada  
pointe fermée  
punta chiusa



**MAB24-169**  
0.3 mm Ø

**MAB24-170**  
0.4 mm Ø

Stahldraht  
Snare Wire  
Alambre  
fil en acier  
filo in acciaio  
Rolle mit  
coil of  
rolo de  
rouleau de  
rotolo di  
**10 m**

Otologie . Otologie . Otologia  
Ohrpolypenzangen  
Ear Polypus Forceps  
Pinzas para pólipos auriculares  
Pincas pour polypes auriculaires  
Pinze per polipi auricolari

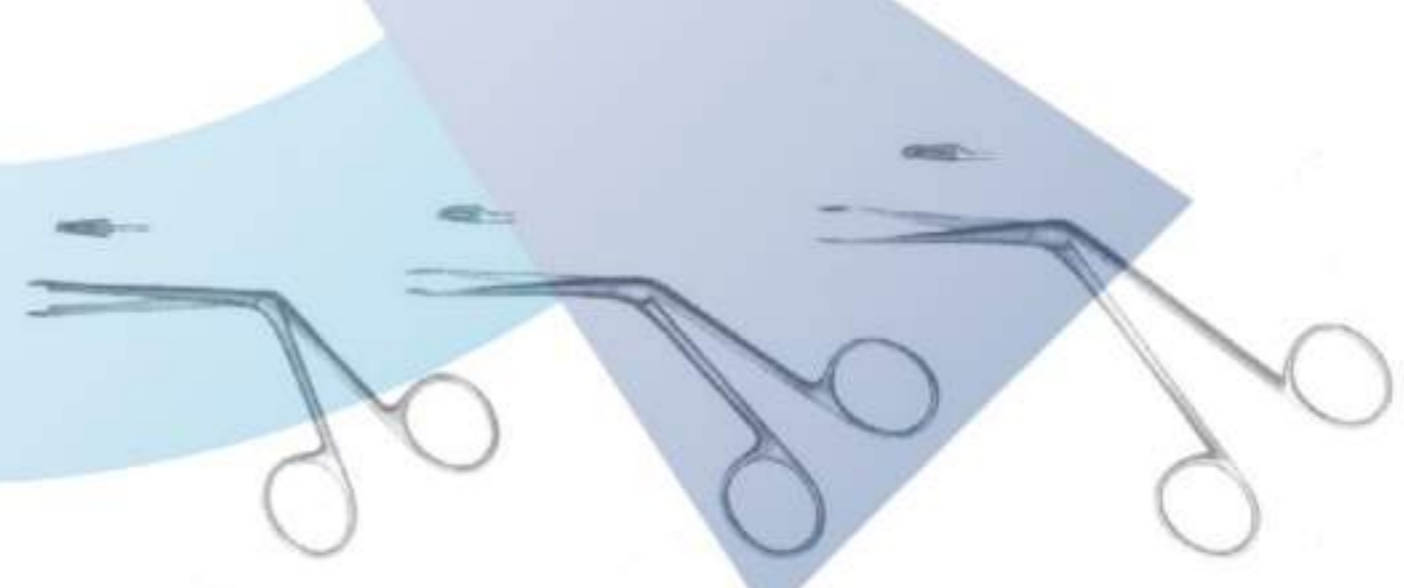

**Littauer**  
MAB24-177  
10 cm / 4"

**Hartmann**  
MAB24-178  
12 cm / 4 3/4"  
feines Modell  
fine model  
modelo fino  
modèle fin  
modello fino

**Hartmann**  
MAB24-179  
14 cm / 5 1/2"  
normales Modell  
regular model  
modelo regular  
modèle normal  
modello normale



**Troeltsch (Wilde)**  
MAB24-171  
10.5 cm / 4"

**Troeltsch (Wilde)**  
MAB24-172  
11 cm / 4 3/8"

**Troeltsch (Wilde)**  
MAB24-173  
12.5 cm / 5"

**Grünwald**  
MAB24-174  
14.5 cm / 5 3/4"

**Jansen**  
MAB24-175  
16 cm / 6 1/4"



**Buck**  
MAB24-180  
11.5 cm / 4 1/2"  
Fremdkörperzängchen  
Foreign Body Forceps  
Pinza para cuerpos extraños  
Pince pour corps étrangers  
Pinza per corpi estranei

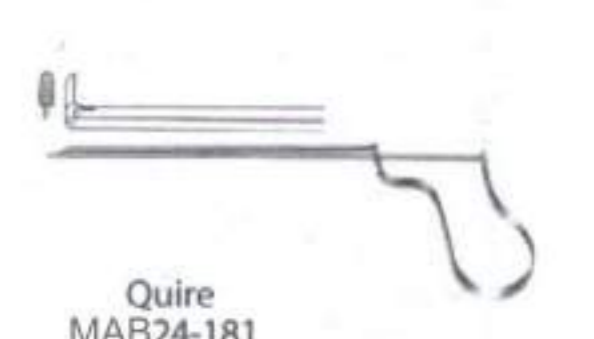

**Quire**  
MAB24-181  
10.5 cm / 4"  
Fremdkörperhebel  
Foreign Body Lever  
Elevador para cuerpos extraños  
Levier pour corps étrangers  
Leve per corpi estranei



Otologie . Otology . Otología  
 Ohrpolypenzangen  
 Ear Polypus Forceps  
 Pinzas para pólipos auriculares  
 Pinces pour polypes auriculaires  
 Pinze per polipi auricolari

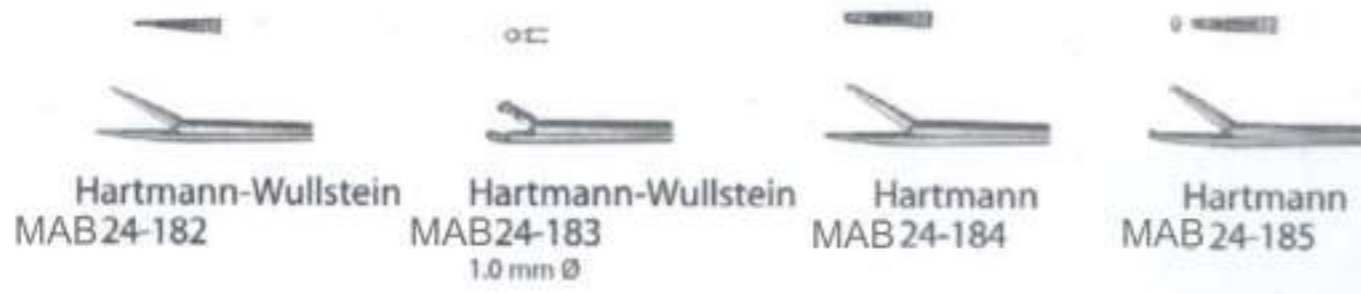

MAB24-186  
 14 cm / 5 1/2"  
 Schaftlänge  
 shaft length  
 longitud del vástago  
 longueur du tige  
 lunghezza del gambo  
 140 mm



MAB-192 MAB-193

Otologie . Otologie . Otologia  
 Ohr-Knochenstanzen  
 Mastoid Rongeurs  
 Pinzas cortantes para huesos  
 Ostéotomes emporte-pièces  
 Pinze osteotomi



Citelli  
 MAB24-194  
 3 mm Schnitt  
 3 mm cut  
 corte 3 mm  
 coupe 3 mm  
 taglio 3 mm



Beyer  
 MAB24-195  
 2 mm Schnitt  
 2 mm cut  
 corte 2 mm  
 coupe 3 mm  
 taglio 3 mm



Beyer  
 MAB24-196  
 1 mm Schnitt  
 1 mm cut  
 corte 1 mm  
 coupe 1 mm  
 taglio 1 mm

Otologie . Otology . Otología  
 Ohrküretten  
 Ear Currettes  
 Curetas auriculares  
 Curettes auriculaires  
 Curette auricolari



MAB24-197  
 13 mm / 5"  
 stumpf  
 blunt  
 romo  
 mousse  
 smusso

Langenbeck



Shapleigh

Otologie . Otologie . Otologia  
 Ohrküretten, Ohrlöffel  
 Ear Currettes, Ear Scoop  
 Curetas auriculares, Cucharilla auricular  
 Curettes auriculaires, Curette auriculaire  
 Curette auricolari, Curetta auricolare



stumpf  
 blunt  
 romo  
 mousse  
 smusso

MAB-204 17 mm / 6 3/4" Fig.000  
 MAB-205 17 mm / 6 3/4" Fig.00  
 MAB-206 17 mm / 6 3/4" Fig.0  
 MAB-207 17 mm / 6 3/4" Fig.1  
 MAB-208 17 mm / 6 3/4" Fig.2  
 MAB-209 17 mm / 6 3/4" Fig.3  
 MAB-210 17 mm / 6 3/4" Fig.4



scharf  
 sharp  
 agudo  
 aigu  
 appuntito

MAB-211 17 mm / 6 3/4" Fig.000  
 MAB-212 17 mm / 6 3/4" Fig.00  
 MAB-213 17 mm / 6 3/4" Fig.0  
 MAB-214 17 mm / 6 3/4" Fig.1  
 MAB-215 17 mm / 6 3/4" Fig.2  
 MAB-216 17 mm / 6 3/4" Fig.3  
 MAB-217 17 mm / 6 3/4" Fig.4

Buck



stumpf  
 blunt  
 romo  
 mousse  
 smusso

MAB24-200 17 mm / 6 3/4" Fig.00  
 MAB24-201 17 mm / 6 3/4" Fig.0  
 MAB24-202 17 mm / 6 3/4" Fig.1  
 MAB24-203 17 mm / 6 3/4" Fig.2

Buck



MAB24-218  
 17 mm / 6 3/4"  
 scharf  
 sharp  
 agudo  
 aigu  
 appuntito

Jansen

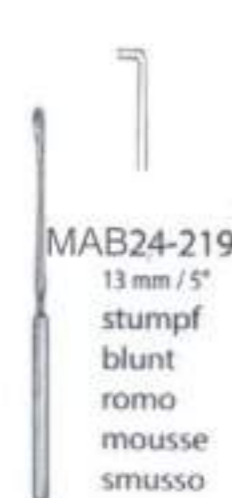

MAB24-219  
 13 mm / 5"  
 stumpf  
 blunt  
 romo  
 mousse  
 smusso

Gross  
 Ohrlöffel und Hähchen  
 Ear Scoop/Hook  
 Cucharilla/ganchito auricular  
 Curette/crochet auriculaire  
 Cucchiaio/uncino auricolare



Otologie . Otology . Otología  
Fremdkörperinstrumente  
Foreign Body Instruments  
Instrumentos para cuerpos extraños  
Instruments pour corps étrangers  
Strumenti per corpi estranei



MAB24-220  
16.5 mm / 6 1/2"

Weber-Loch  
Ohrschlinge  
Ear Loop  
Asa auricular  
Anse auriculaire  
Ansa auricolare



MAB24-221  
16 mm / 6 1/4"

Billeau  
Ohrschlinge  
Ear Loop  
Asa auricular  
Anse auriculaire  
Ansa auricolare



MAB24-222  
16 mm / 6 1/4"



MAB24-223  
16 mm / 6 1/4"

Otologie . Otologie . Otologia  
Ohrhäkchen  
Ear Hooklets  
Ganchitos auriculares  
Crochets auriculaires  
Uncini auricolari



MAB24-227 MAB24-228 MAB24-229  
14 cm / 5 1/2" 14 cm / 5 1/2" 14 cm / 5 1/2"  
klein mittel groß  
small medium large  
pequeño mediano grande  
petit moyen grand  
piccolo medio grande

Lucae



MAB24-230 MAB24-231  
17 cm / 6 3/4" 17 cm / 6 3/4"  
lang long  
largo long  
lungo long

Day



MAB24-224  
15.5 mm / 6"

Moldenhauer  
Fremdkörperheber  
Foreign Body Lever  
Elevador para cuerpos extraños  
Levier pour corps étrangers  
Leva per corpi estranei



MAB24-225  
15 mm / 6"

Zaufal  
Fremdkörperheber  
Foreign Body Lever  
Elevador para cuerpos extraños  
Levier pour corps étrangers  
Leva per corpi estranei



MAB24-226  
16 mm / 6 1/4"  
scharf  
sharp  
agudo  
aigu  
appuntito

Hartmann  
Ohrhäkchen  
Ear Hooklet  
Ganchito auricular  
Crochet auriculaire  
Uncino auricolare



MAB24-231 MAB24-233 MAB24-234 MAB24-235 MAB24-236 MAB24-237 MAB24-238  
14 cm / 5 1/2" 14 cm / 5 1/2" 14 cm / 5 1/2" 14 cm / 5 1/2" 14 cm / 5 1/2" 14 cm / 5 1/2" 14 cm / 5 1/2"  
Fig. 1 Fig. 2 Fig. 3 Fig. 4 Fig. 5 Fig. 6 Fig. 7

Wagener

Otologie . Otology . Otologia  
Trommelfellnadeln  
Tympanum Needles  
Agujas para tímpano  
Aiguilles pour le tympan  
Aghi per timpano



MAB24-239  
14 cm / 5 1/4"

Politzer  
Furunkelmesser  
Furuncle Knife  
Cuchillo para furúnculos  
furunculotome  
Coltello per foruncoli



MAB24-240  
17.5 cm / 7"

Politzer

Otologie . Otologie . Otologia  
Ohrspatzen, Ohröffel  
Ear Periosteal Elevators, Ear Scoops  
Legras auriculares, Cucharillas auriculares  
Rugines-raspatoires auriculaires, Curettes auriculaires  
Raspatori auricolari, Curette auricolari



MAB24-245  
20.5 cm / 8"  
6 mm

Lempert



MAB24-246  
18 cm / 7"  
6 mm

Lempert

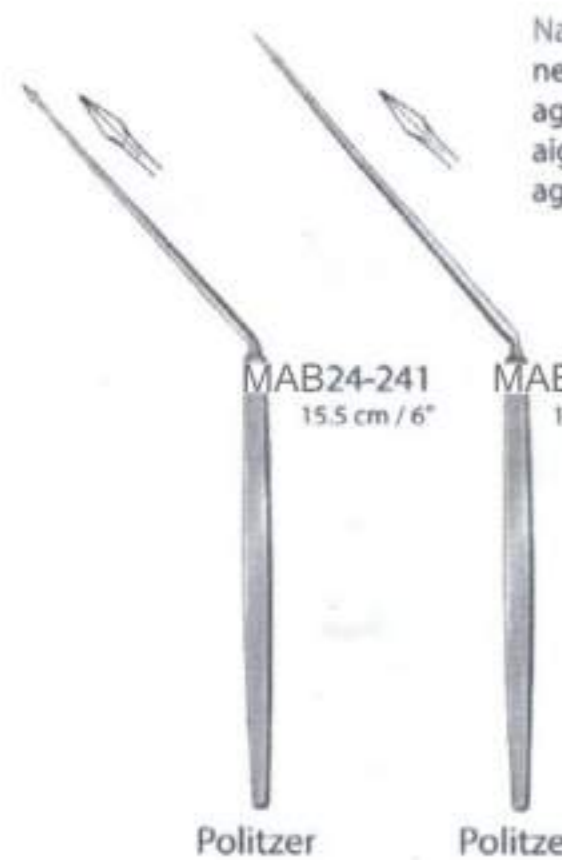

MAB24-241  
15.5 cm / 6"

MAB24-242  
16 cm / 6 1/4"

Politzer

Politzer

Nadel quergestellt  
needle horizontally  
aguja en posición horizontal  
aiguille horizontale  
ago orizzontale



MAB24-243  
17.5 cm / 7"

MAB24-244  
17.5 cm / 7"

Lucae

Lucae



Lempert  
scharf  
sharp  
agudo  
aigu  
appuntito



MAB24-247  
21.5 cm / 8 1/2"

MAB24-248  
21.5 cm / 8 1/2"

MAB24-249  
21.5 cm / 8 1/2"

MAB24-250  
21.5 cm / 8 1/2"

MAB24-251  
21.5 cm / 8 1/2"



Otologie . Otology . Otología  
 Ohrspritzen  
 Ear Syringes  
 Jeringas auriculares  
 Seringues auriculaires  
 Siringhe auricolari

## MAB 25

Rhinologie  
 Rhinology  
 Rinologia  
 Rhinlogie  
 Rinologia

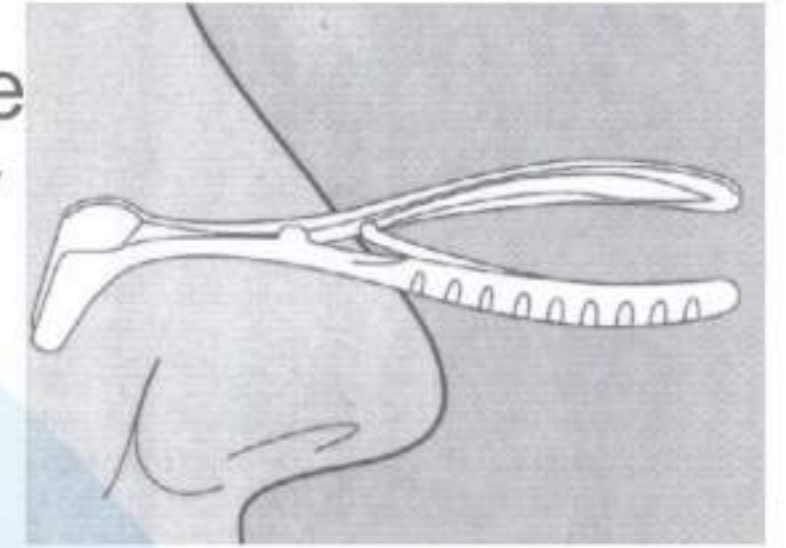

**MAB24-252**  
**50 ml**  
 komplett mit Teller und 2 Ansätzen  
 complete with protection disc and 2 tips  
 completo con disco protector y 2 puntas  
 complet avec plaque de protection et 2 pointes  
 completo con disco protettivo e 2 punte

**MAB24-253**  
**100 ml**  
 komplett mit Teller und 2 Ansätzen  
 complete with protection disc and 2 tips  
 completo con disco protector y 2 puntas  
 complet avec plaque de protection et 2 pointes  
 completo con disco protettivo e 2 punte

Rhinologie . Rhinology . Rinologia  
 Nasenspekula  
 Nasal Specula  
 Espéculos nasales  
 Spéculums nasaux  
 Specoli nasali



Goldsmith (Thudichum)



**MAB25-001**  
 6.5 cm / 2 1/2"  
 Fig.1



**MAB25-002**  
 6.5 cm / 2 1/2"  
 Fig.2



**MAB25-003**  
 6.5 cm / 2 1/2"  
 Fig.3



Rhinologie . Rhinology . Rinologia  
 Nasenspekula  
 Nasal Specula  
 Espéculos nasales  
 Spéculums nasaux  
 Specoli nasali



**MAB25-007**  
 13 cm / 5"  
 17 mm

Martin

**MAB25-008**  
 12.5 cm / 5"  
 17 mm

Martin

**MAB25-009**  
 13 cm / 5"  
 17 mm

Tieck-Halle

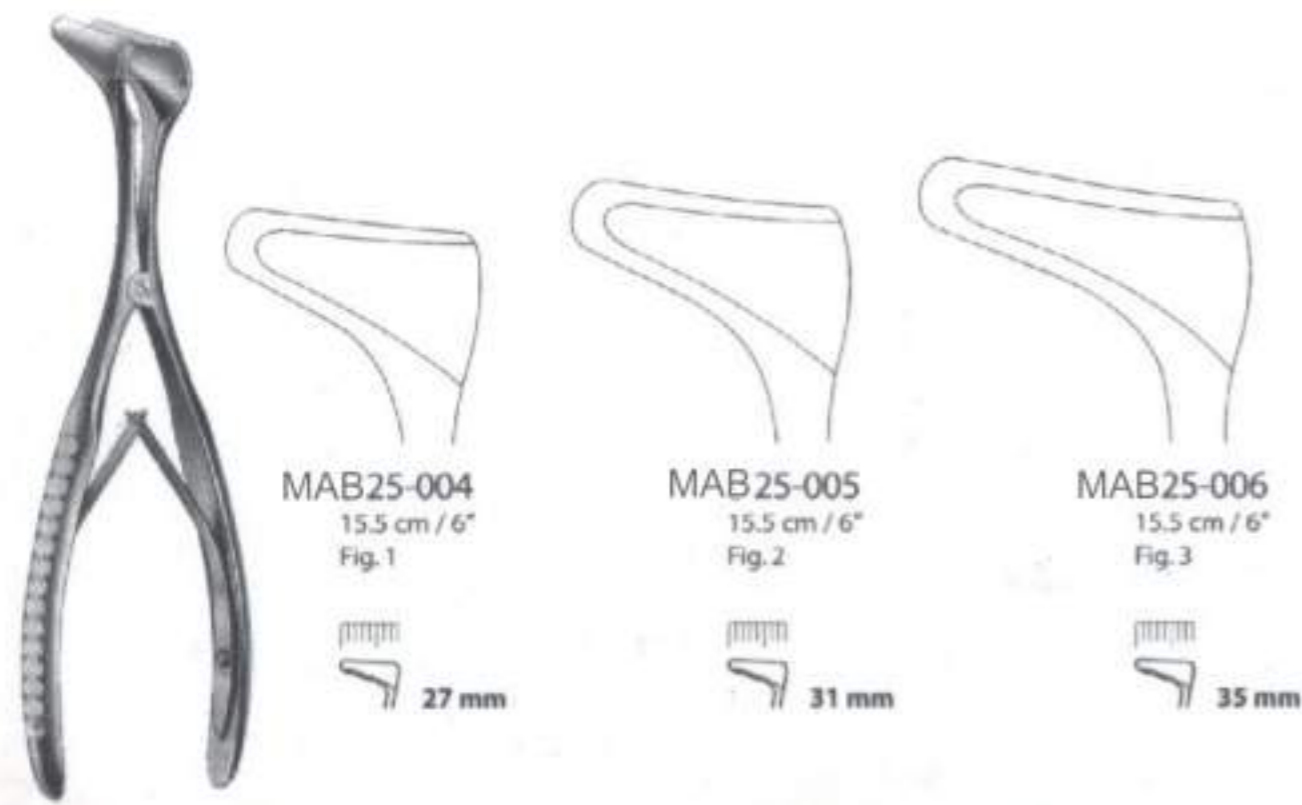

**MAB25-004**  
 15.5 cm / 6"  
 Fig.1



**MAB25-005**  
 15.5 cm / 6"  
 Fig.2



**MAB25-006**  
 15.5 cm / 6"  
 Fig.3



Hartmann-Halle

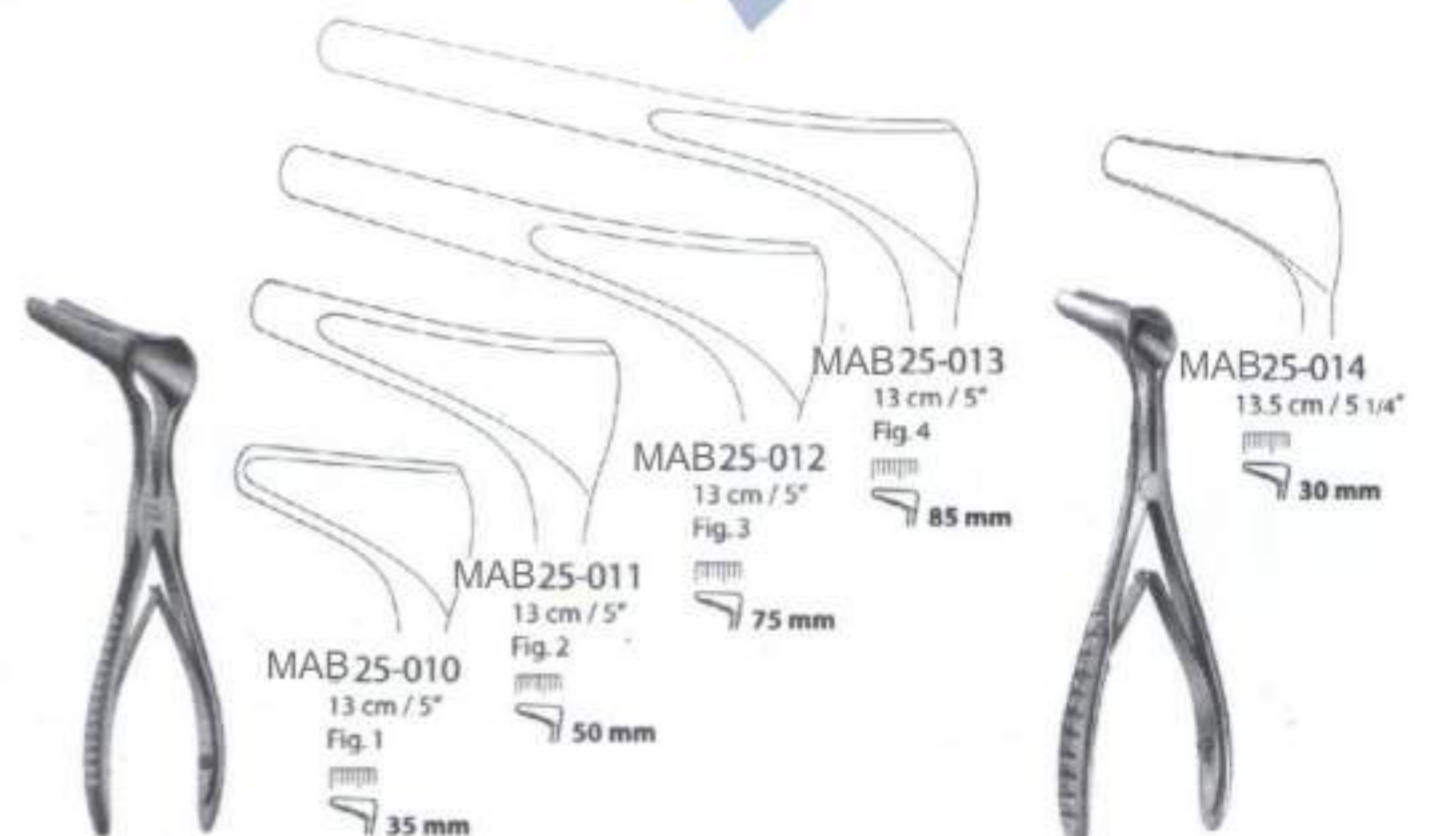

**MAB25-010**  
 13 cm / 5"  
 Fig.1  
 35 mm

Killian

**MAB25-011**  
 13 cm / 5"  
 Fig.2  
 50 mm

**MAB25-012**  
 13 cm / 5"  
 Fig.3  
 75 mm

**MAB25-013**  
 13 cm / 5"  
 Fig.4  
 85 mm

**MAB25-014**  
 13.5 cm / 5 1/4"  
 30 mm

Modell Wien



Rhinologie . Rhinology . Rinologia  
 Nasenspekula  
 Nasal Specula  
 Espéculos nasales  
 Spéculums nasaux  
 Specoli nasali

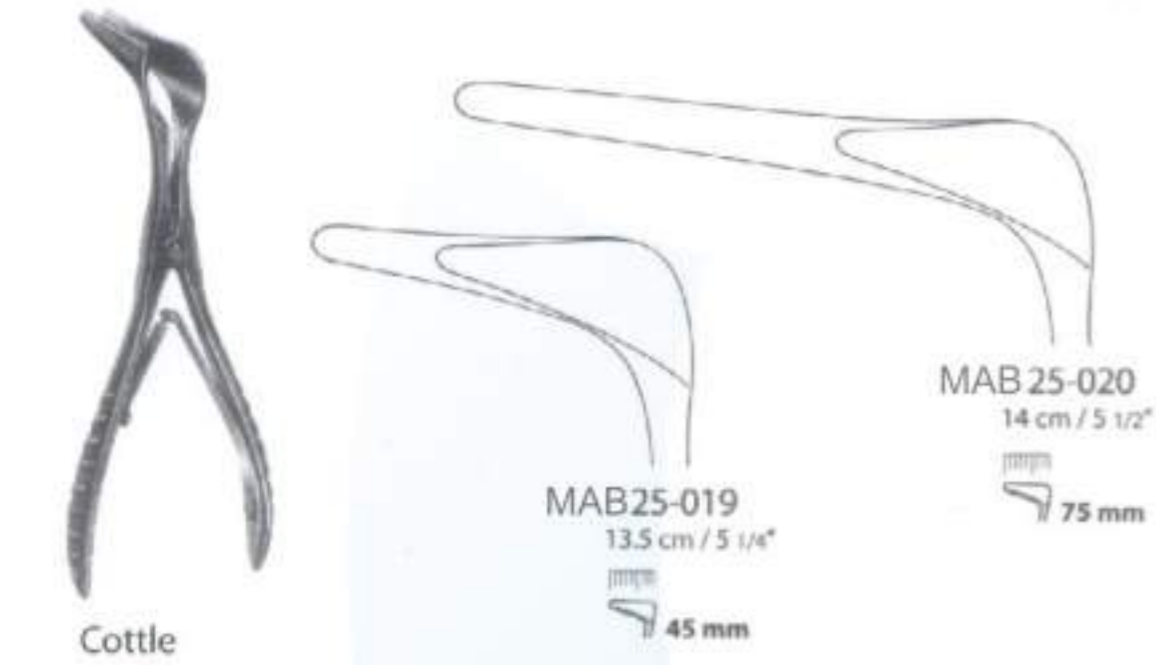
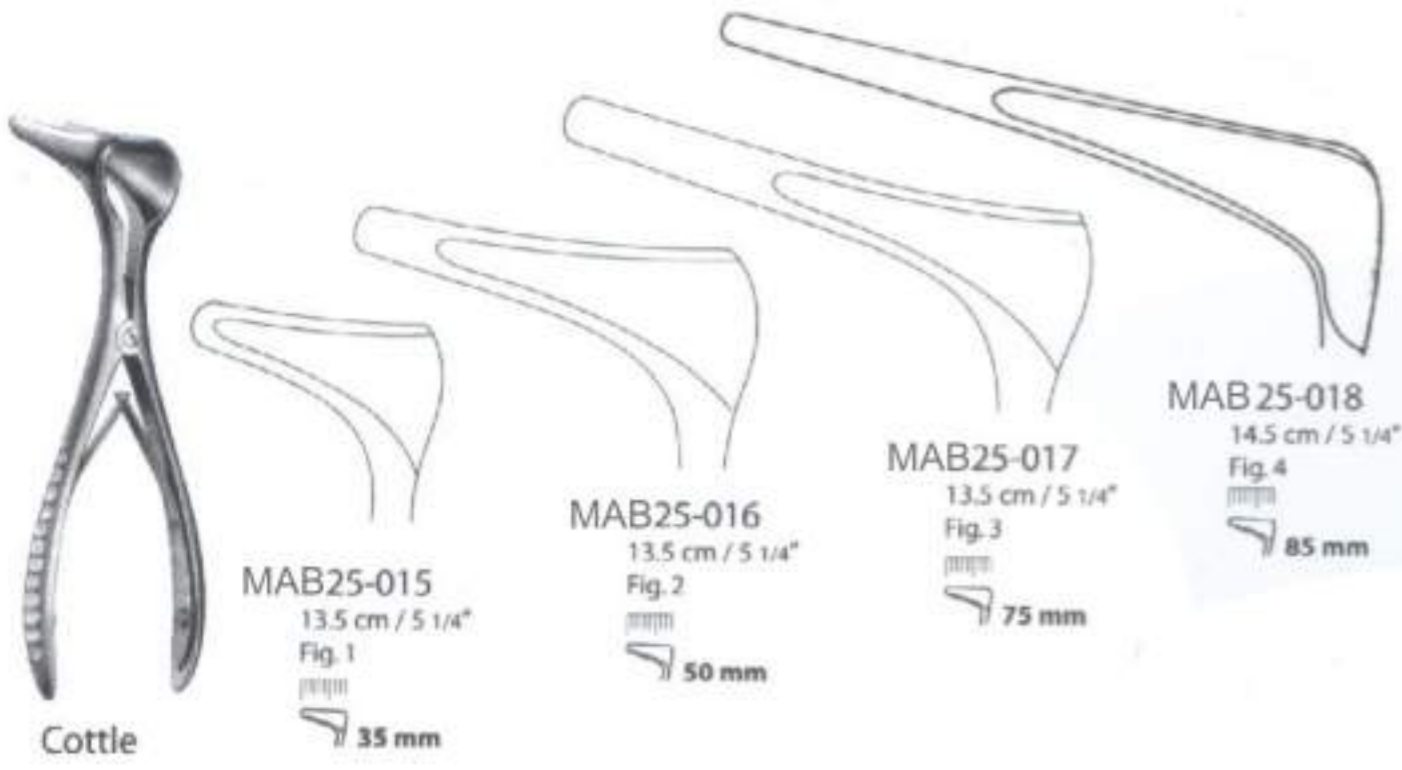

Rhinologie . Rhinologie . Rinologia  
 Nasenpolypenzangen, Septumzangen  
 Nasal polypus Forcps, Septum Forceps  
 Pinzas para pólipos nasales, Pinzas para tabique nasal  
 Pincas à polypes nasaux, Pincas pour la cloison nasale  
 pinze per polipi nasali, Pinze per il setto nasale

Rhinologie . Rhinologie . Rinologia  
 Polypenschnürer  
 Polypus Snares  
 Polipótomos  
 Serre-noeuds pour polypes  
 Serranodi per polipi



Rhinologie . Rhinology . Rinologia  
 Nasentamponpinzetten  
 Nasal Tampon Forceps  
 Pinzas para taponamiento  
 Pincas à pansements  
 Pinze per medicature



Rhinologie . Rhinology . Rinologia  
 Septumzangen, Siebbeinzangen  
 Septum Forceps, Ethmoid Bone Forceps  
 Pinzas para tabique nasal, Pinzas para etmoides  
 Pincas pour la cloison nasale, Pincas éthmoidales  
 Pinze per il setto nasale, Pinze etmoidali

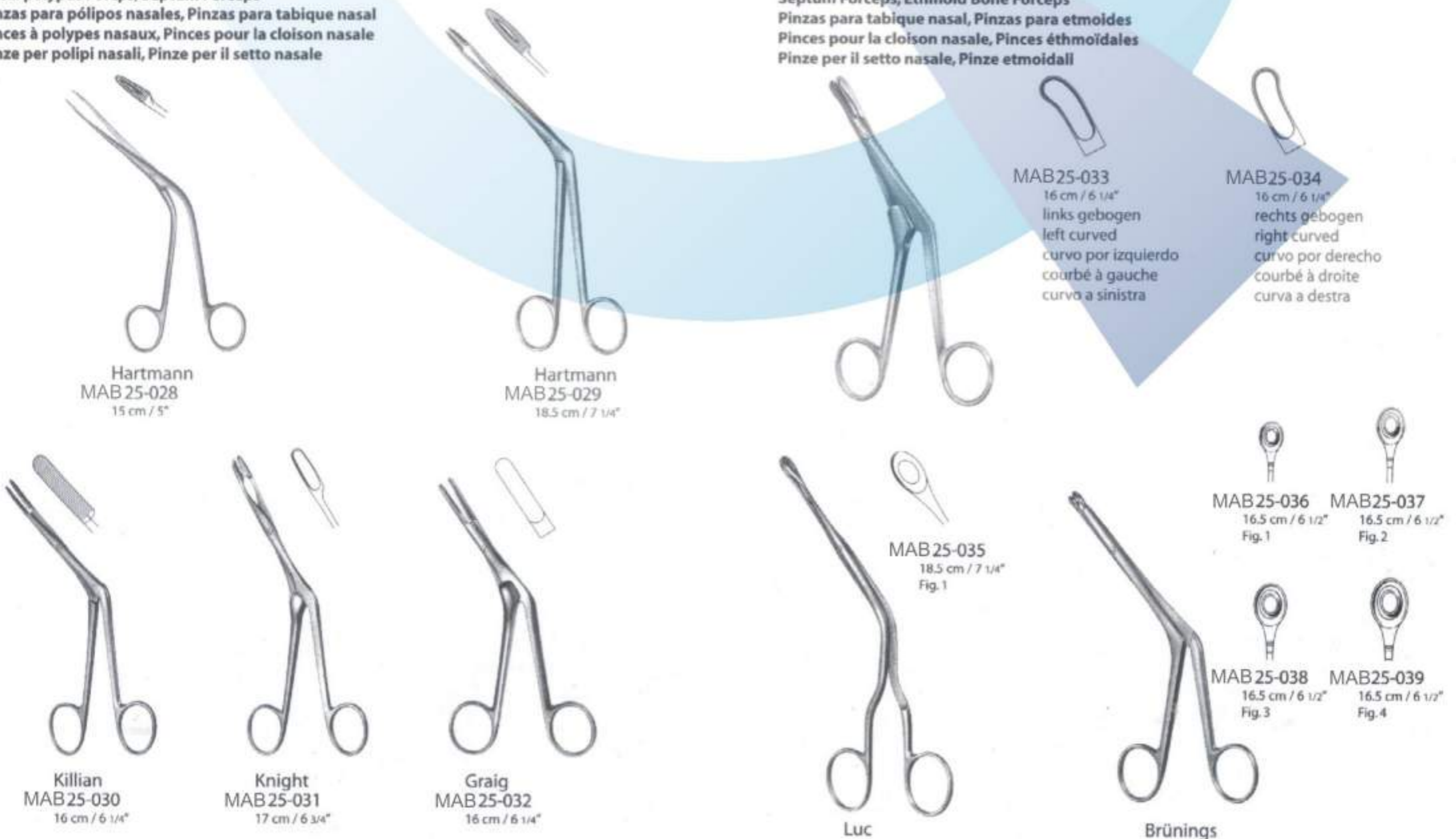



Rhinologie . Rhinologie . Rinologia  
 Siebbeinzangen  
 Ethmoid Bone Forceps  
 Pinzas para etmoides  
 Pincas éthmoidales  
 Pinze etmoidali

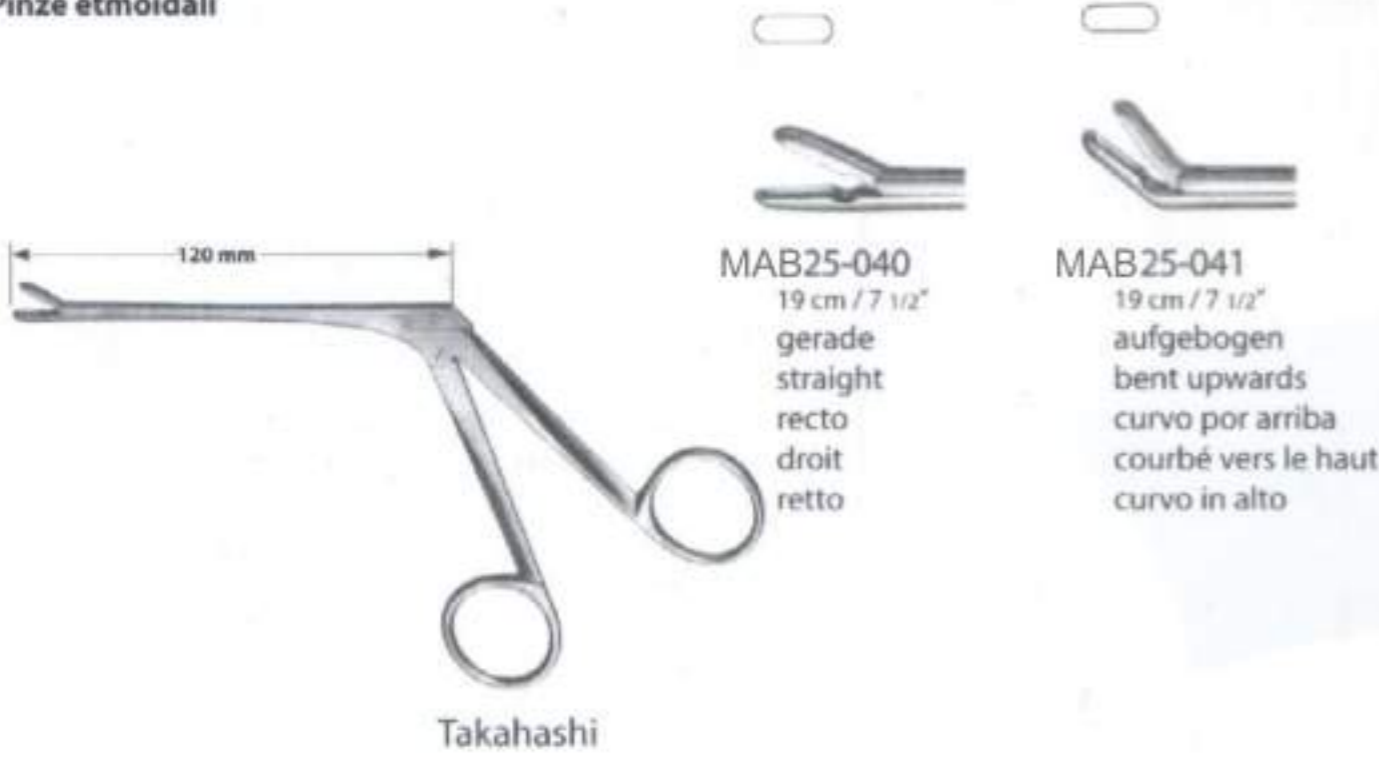

Rhinologie . Rhinology . Rinologia  
 Scharfe Nasenzangen, Siebbeinzangen  
 Nasal Cutting Forceps, Ethmoid Bone Forceps  
 Pinzas nasales cortantes, Pinzas para etmoides  
 Pincas nasales coupantes, Pincas éthmoidales  
 Pinze taglianti per il naso, Pinze etmoidali

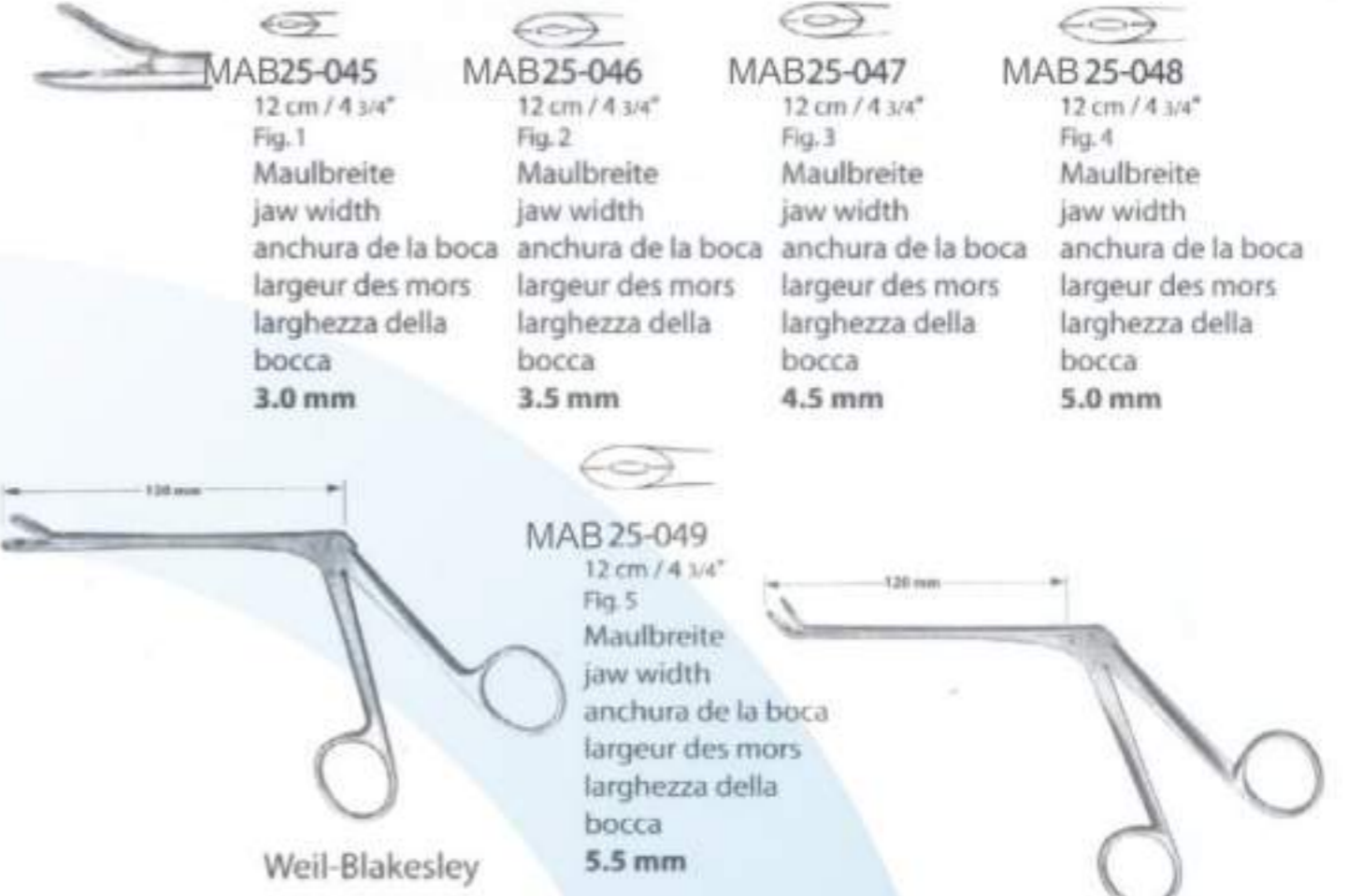

Rhinologie . Rhinologie . Rinologia  
 Siebbeinzangen, Scharfe Nasenzangen  
 Ethmoid Bone Forceps, Nasal Cutting Forceps  
 Pinzas para etmoides, Pinzas nasales cortantes  
 Pincas éthmoidales, Pincas nasales coupantes  
 Pinze etmoidali, Pinze taglianti per il naso



Rhinologie . Rhinology . Rinologia  
 Scharfe Nasenzangen  
 Nasal Cutting Forceps  
 Pinzas nasales cortantes  
 Pincas nasales coupantes  
 Pinze taglianti per il naso

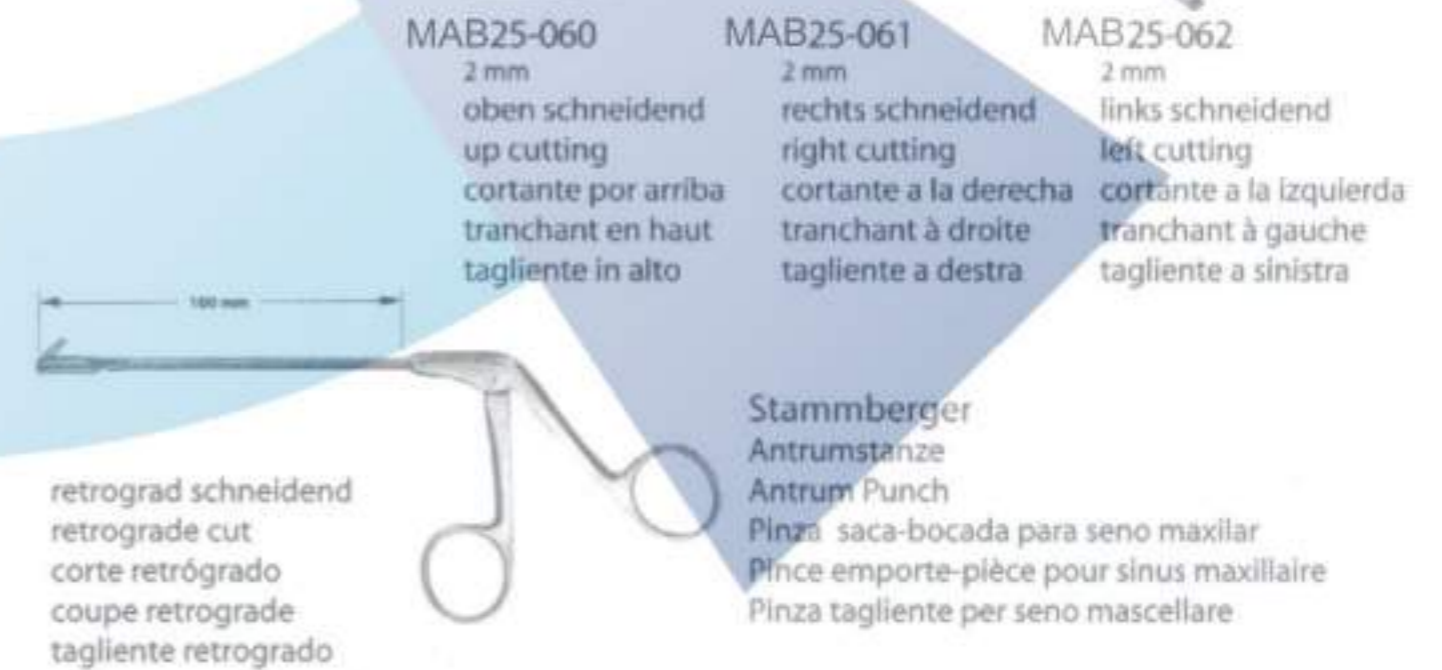



Rhinologie . Rhinologie . Rinologia  
Septumzangen  
Septum Forceps  
Pinzas para tabique nasal  
Pincas pour la cloison nasale  
Pinze per il setto nasale



Middleton-Jansen  
MAB25-068  
19 cm / 7 1/2"



Middleton-Jansen  
MAB25-069  
19 cm / 7 1/2"



Caplan  
MAB25-070  
20 cm / 8"  
eine Schneide gezahnt  
one toothed cutting edge  
una hoja dentada  
une lame dentelée  
una lama dentata



Rubin  
MAB25-072  
21 cm / 8 1/4"



Rubin  
MAB25-071  
Schutzkappe  
Protection Cap  
Caperuza protectora  
Capuchon protecteur  
Calotta protettiva

Rhinologie . Rhinologie . Rinologia  
Keilbeinstanzen  
Sphenoid Bone Punches  
Pinzas sacabocadas para esfenoides  
Pincas emporte-pièces pour sinus sphénoïdal  
Pinze taglianti per seno sfenoidale



4 x 4 mm  
Hajek  
MAB25-073  
14 cm / 5 1/2"  
oben schneidend  
up cutting  
cortante por arriba  
tranchant en haut  
tagliante in alto



4 x 4 mm  
Hajek  
MAB25-074  
14 cm / 5 1/2"  
unten schneidend  
down cutting  
cortante por abajo  
tranchant en bas  
tagliante in basso



3.5 x 3.5 mm  
Hajek-Kofler  
MAB25-075  
14 cm / 5 1/2"  
oben schneidend  
up cutting  
cortante por arriba  
tranchant en haut  
tagliante in alto



3.5 x 3.5 mm  
Hajek-Kofler  
MAB25-076  
14 cm / 5 1/2"  
unten schneidend  
down cutting  
cortante por abajo  
tranchant en bas  
tagliante in basso



Rhinologie . Rhinologie . Rinologia  
Keilbeinstanzen  
Sphenoid Bone Punches  
Pinzas sacabocadas para esfenoides  
Pincas emporte-pièces pour sinus sphénoïdal  
Pinze taglianti per seno sfenoidale



Ferris-Smith-Kerrison



MAB25-077  
18 cm / 7"  
oben schneidend  
up cutting  
cortante por arriba  
tranchant en haut  
tagliante in alto



MAB25-078  
18 cm / 7"  
unten schneidend  
down cutting  
cortante por abajo  
tranchant en bas  
tagliante in basso



MAB25-079  
18 cm / 7"  
schräg vorwärts schneidend  
obliquely forward cutting  
cortante oblicuo hacia adelante  
tranchant oblique en avant  
tagliante obliquo in avanti  
Biss  
bite  
corte  
coupe  
taglio  
3.0 mm



MAB25-080  
18 cm / 7"  
schräg vorwärts schneidend  
obliquely forward cutting  
cortante oblicuo hacia adelante  
tranchant oblique en avant  
tagliante obliquo in avanti  
Biss  
bite  
corte  
coupe  
taglio  
5.0 mm



Ferris-Smith-Kerrison

Rhinologie . Rhinologie . Rinologia  
Antrumstanzen  
Antrum Punches  
Pinzas sacabocadas para seno maxilar  
Pincas emporte-pièces pour sinus maxillaire  
Pinze taglianti per seno mascellare

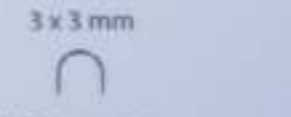

3 x 3 mm  
MAB25-081  
oben schneidend  
up cutting  
cortante por arriba  
tranchant en haut  
tagliante in alto



4 x 4 mm  
MAB25-082  
oben schneidend  
up cutting  
cortante por arriba  
tranchant en haut  
tagliante in alto



5 x 5 mm  
MAB25-083  
oben schneidend  
up cutting  
cortante por arriba  
tranchant en haut  
tagliante in alto



6 x 6 mm  
MAB25-084  
unten schneidend  
up cutting  
cortante por arriba  
tranchant en haut  
tagliante in alto



Kerrison



Rhinologie . Rhinology . Rinologia  
 Rhinoplastik-Messer  
 Rhinoplastic Knives  
 Cuchillos para rinoplástica  
 Couteaux pour plastie du nez  
 Bisturi per plastica nasale

Rhinologie . Rhinologie . Rinologia  
 Septummesser, Schwingmesser  
 Septum Knives, Swivel Knives  
 Cuchillos para tabique nasal  
 Bistouris pour la cloison nasale  
 Bisturi per il setto nasale



MAB25-085 15 cm / 6" Fig.1  
 MAB25-086 15 cm / 6" Fig.2

Joseph



MAB25-087 16.5 cm / 6 1/2"

Fomon



MAB25-091 16.5 cm / 6 1/2"

Mukosamesser  
 Mucosa Knife  
 Cuchillo para mucosa  
 Couteau pour muqueuse  
 Bisturi per mucosa

Freer



MAB25-092 19 cm / 7 1/2"

Freer



MAB25-093 19 cm / 7 1/2"

Freer



MAB25-088 16 cm / 6 1/4"

Converse



MAB25-089 15 cm / 6"

Joseph



MAB25-090 14 cm / 5 1/2"

Cottle



MAB-094 21 cm / 8 1/4" 3.0 mm

Ballenger

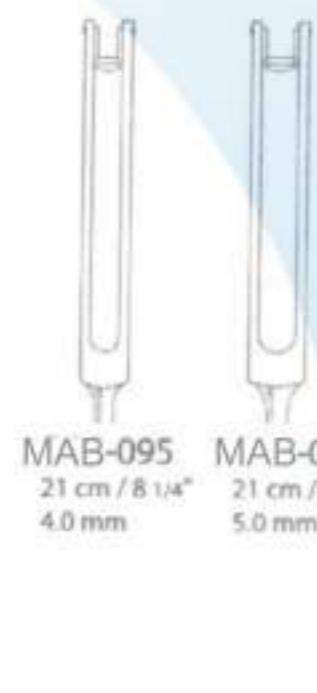

MAB-095 21 cm / 8 1/4" 4.0 mm



MAB-096 21 cm / 8 1/4" 5.0 mm



MAB-097 20 cm / 8" 3.0 mm

Ballenger

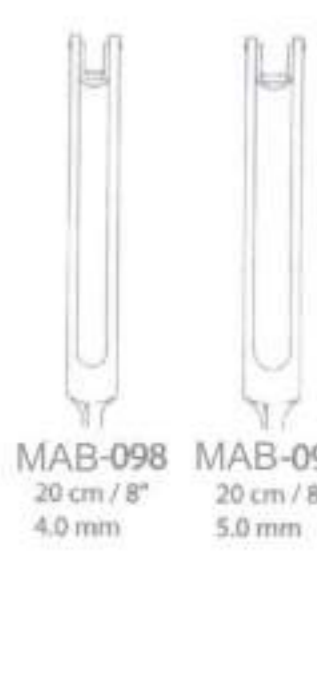

MAB-098 20 cm / 8" 4.0 mm



MAB-099 20 cm / 8" 5.0 mm

Rhinologie . Rhinology . Rinologia  
 Septumelevatorien  
 Septum Elevators  
 Elevadores para tabique nasal  
 Élévateurs pour la cloison nasale  
 Elevatori per il setto nasale

Rhinologie . Rhinologie . Rinologia  
 Septumelevatorien  
 Septum Elevators  
 Elevadores para tabique nasal  
 Élévateurs pour la cloison nasale  
 Elevatori per il setto nasale



MAB25-100 16.5 cm / 6 1/2"

Brünings  
 Septummesser  
 Septum Knife  
 Cuchillo para tabique nasal  
 Bistouri pour la cloison nasale  
 Bisturi per il setto nasale

McKenty



MAB25-101 15 cm / 6" 4 mm



MAB25-102 15 cm / 6" 5 mm

Halle



MAB25-103 16 cm / 6 1/4" 3.5 mm

Joseph



MAB25-104 16 cm / 6 1/4" 4 mm



MAB25-109 20.5 cm / 8" 4 / 4 mm

McKenty



MAB25-110 19 cm / 7 1/2" 6 / 6 mm

Ballenger-Hajek



MAB25-111 23.5 cm / 9 1/4" 5 x 5 mm

Cottle



MAB25-105 19 cm / 7 1/2" 5 mm  
 scharf  
 sharp  
 agudo  
 aigu  
 acuto

Freer



MAB25-106 19 cm / 7 1/2" 6 mm  
 stumpf  
 blunt  
 romo  
 mousse  
 smusso

Freer



MAB25-107 18.5 cm / 7 1/4" 5 / 5 mm  
 scharf / stumpf  
 sharp / blunt  
 agudo / romo  
 aigu / mousse  
 acuto / smusso

Freer



MAB25-108 20.5 cm / 8" 6 / 5 mm

Freer



MAB25-112 18 cm / 7" 4 / 4 mm

Killian

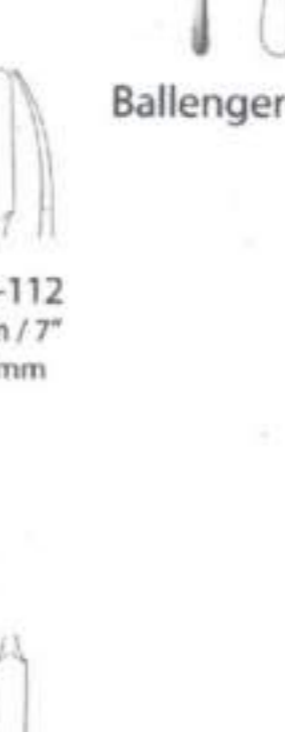

MAB25-113 23 cm / 9" 4.5 x 4.5 mm

Killian



MAB25-114 21.5 cm / 8 1/2" 4 x 4 mm

Pennington



## MAB 26

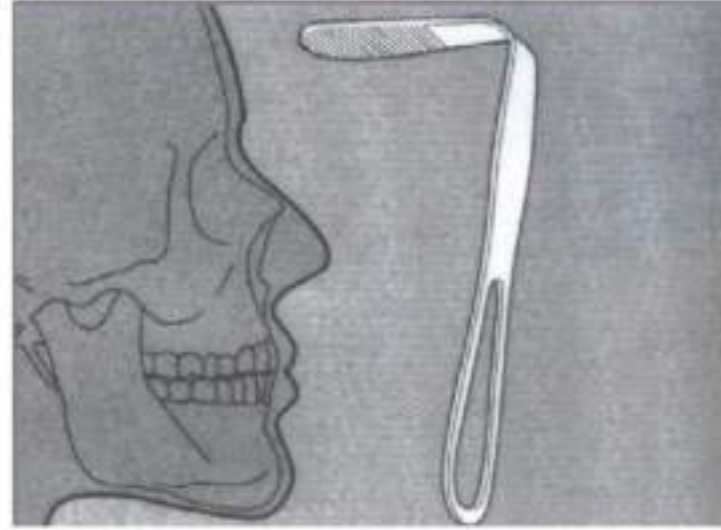

Mund, Kiefer, Geischtschirurgie  
 Oral Maxillo-Facial Surgery  
 Cirguia oral y maxilofacial  
 Chirgie buccale et maxillo-faciale  
 Chirurgia maxillo-facciale

Mund-, Kiefer-, Gesichtschirurgie . Oral Maxillo-Facial Surgery . Cirugía oral y maxilofacial  
 Elevatoren, Transplantatstopfer  
 Elevadores, Graft Packers  
 Elevadores, Atacadores de trasplantes  
 Elévateurs, Pousoirs pour transplantation  
 Elevatori, Turatori per innesti



MAB26-001  
5.0 / 8.0 mm

Terry  
 17 cm / 6 3/4"  
 zur Alveolarlappenabhebung  
 for elevation of alveolar flaps  
 para la elevación de las aletas alveolares  
 pour élévation du lambeau alvéolaire  
 per la elevazione del lembo alveolare



MAB26-002  
11 cm / 4 1/4"

Terry  
 Transplantatstopfer  
 Graft Packer  
 Atacador de trasplantes  
 Pousoir pour transplantation  
 Turatore per innesti



MAB26-003  
13 / 5" mm

Transplantatstopfer  
 Graft Packer  
 Atacador de trasplantes  
 Pousoir pour tarsplantation  
 Turatore per innesti



MAB26-004  
3.0 cm / 7.0 mm

Terry  
 18 cm / 7"  
 für subperiostale Tunnell  
 for subperiosteal tunnels  
 para túneles subperiósticos  
 pour tunnel subpériostale  
 per tunnel supperiostale

Mund-, Kiefer-, Gesichtschirurgie . Chirurgie buccale et maxillo-faciale . Chirurgia maxillo-facciale  
 Mund-, Kiefer-, Gesichtschirurgie . Oral Maxillo-Facial Surgery . Cirugía oral y maxilofacial  
 Sinus-Lift-Küretten  
 Sinus Lift Curettes  
 Curetas para Sinus-lift  
 Curettes pour Sinus-lift  
 Curette per Sinus-lift

Mund-, Kiefer-, Gesichtschirurgie . Chirurgie buccale et maxillo-faciale . Chirurgia maxillo-facciale  
 Mund-, Kiefer-, Gesichtschirurgie . Oral Maxillo-Facial Surgery . Cirugía oral y maxilofacial  
 Sinus-Lift-Küretten  
 Sinus Lift Curettes  
 Curetas para Sinus-lift  
 Curettes pour Sinus-lift  
 Curette per Sinus-lift

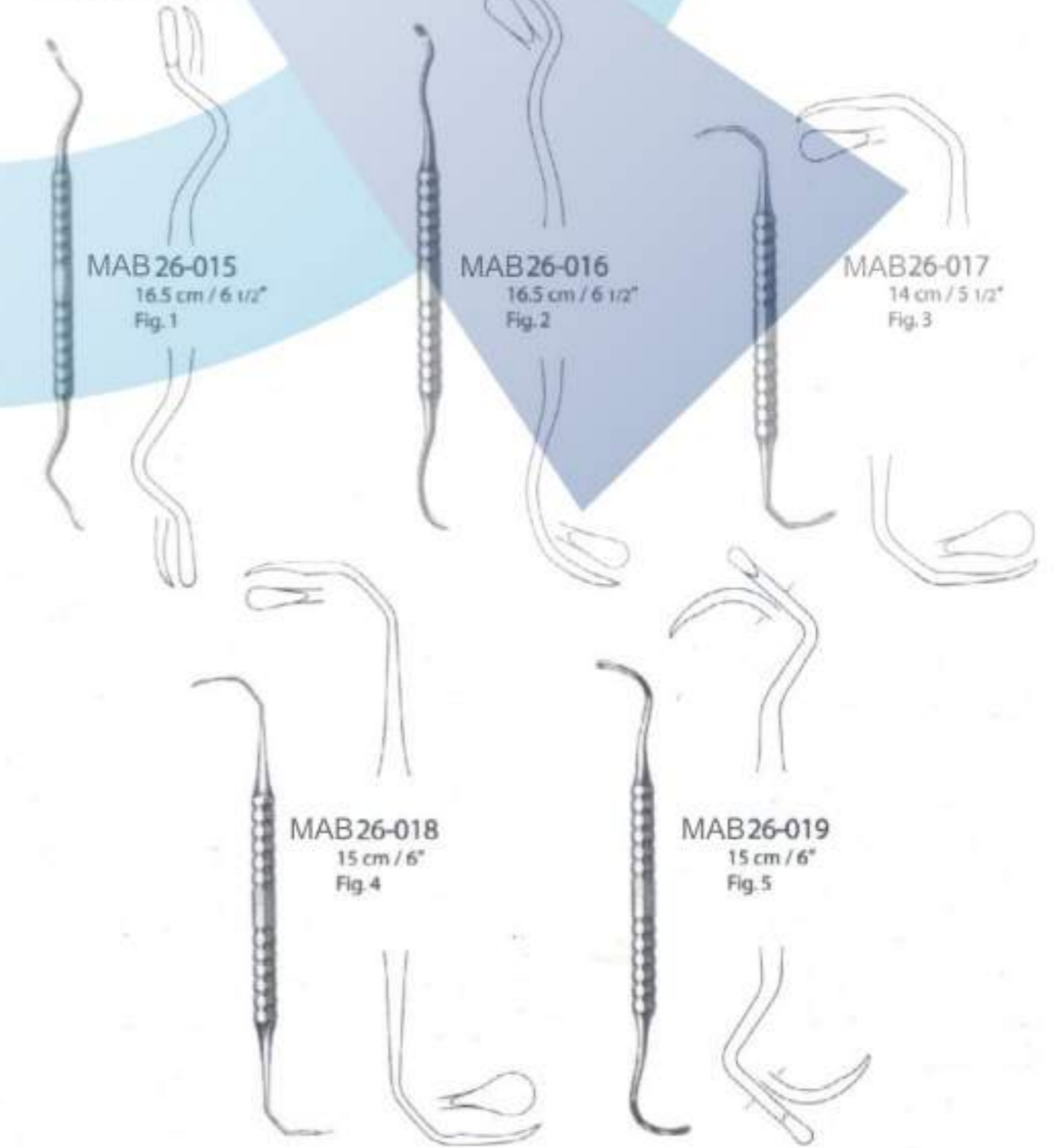



Rhinologie . Rhinologie . Rinologia  
 Osteotome  
 Osteotomes  
 Osteótomos  
 Osteótomes  
 Osteotomi

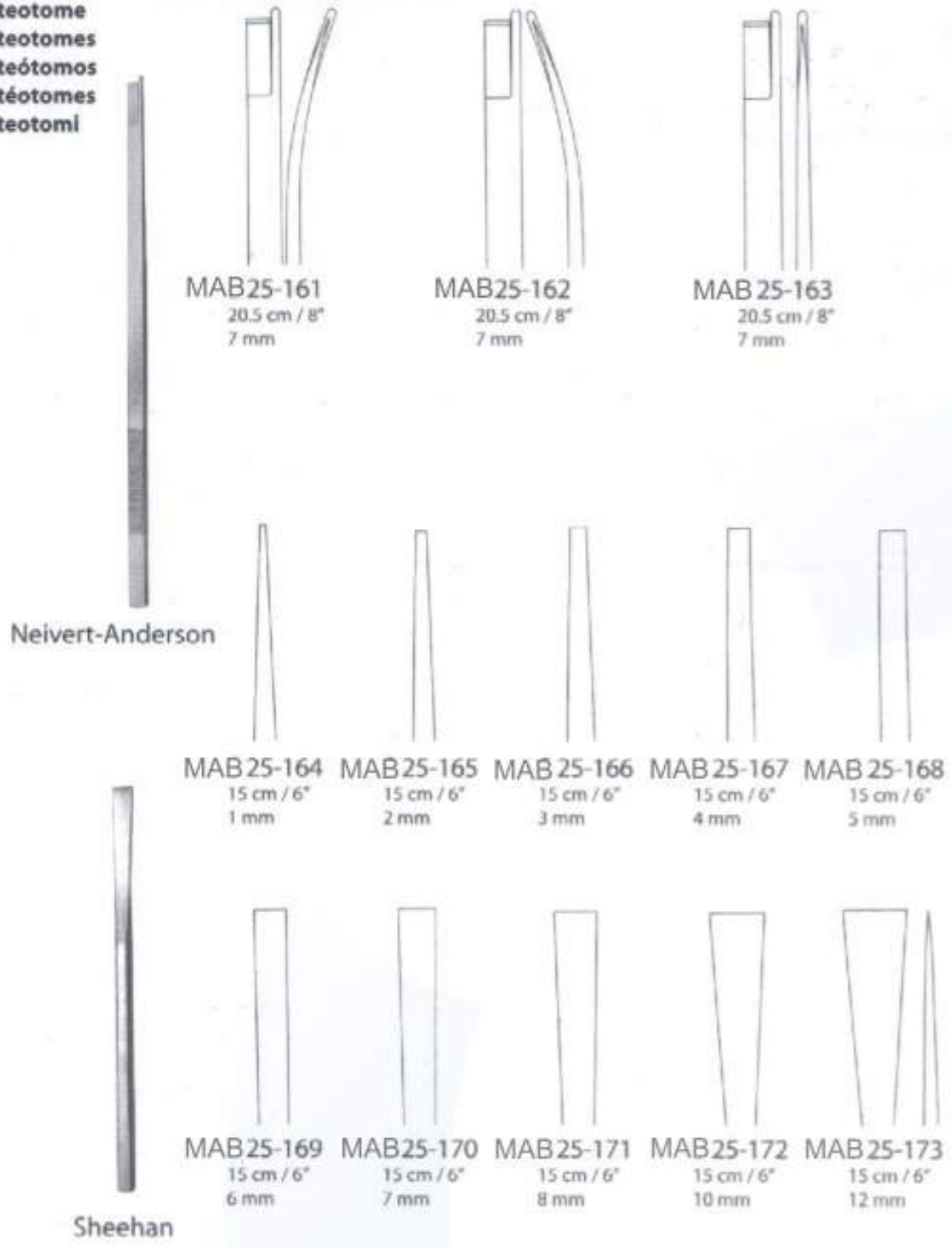

Rhinologie . Rhinology . Rinologia  
 Nasenmeißel, Osteotome, Nasensägen  
 Rhinoplastic Chisels, Osteotomes, Nasal Saws  
 Cinceles nasales, Osteótomos, Sierras nasales  
 Ciseaux-burins nasaux, Osteótomes, Scies nasales  
 Scalpelli nasali, Osteotomi, Seghe nasali



Rhinologie . Rhinology . Rinologia  
 Nasenraspeln, Knochenfeilen, Antrumraspeln  
 Nasal Rasps, Bone Files, Antrum Rasps  
 Escofinas nasales, Limas para huesos, Escofinas para el antro  
 Râpes nasales, Limes à os, Râpes pour antre  
 Raspe nasali, Lime per ossa, Raspe per seno mascellare

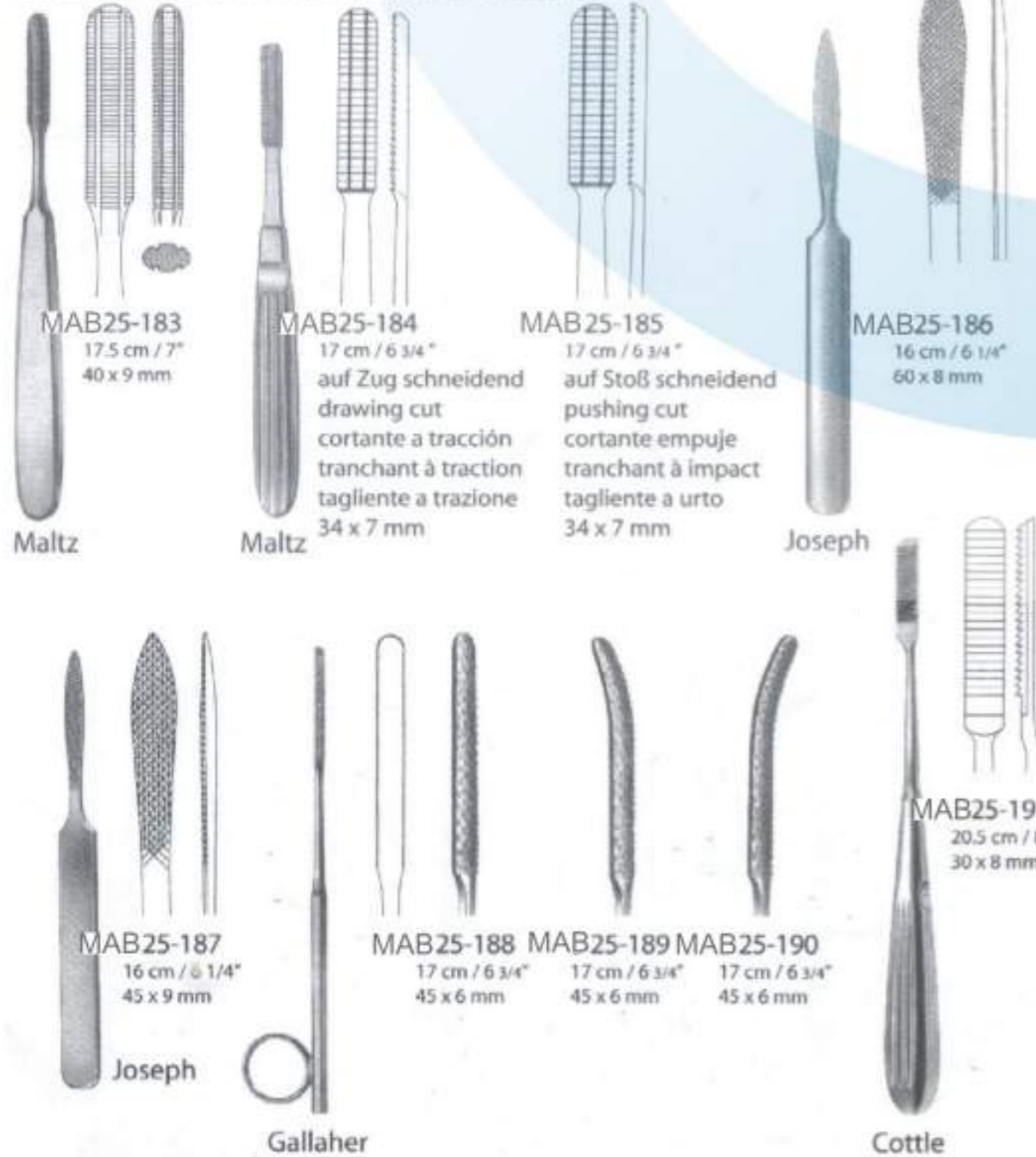

Rhinologie . Rhinologie . Rinologia  
 Glabellaraspeln, Nasenraspeln  
 Glabella Rasps, Nasal Rasps  
 Escofinas para glabella, Escofinas nasales  
 Râpes pour la glabelle, Râpes nasales  
 Raspe per glabella, Raspe nasali

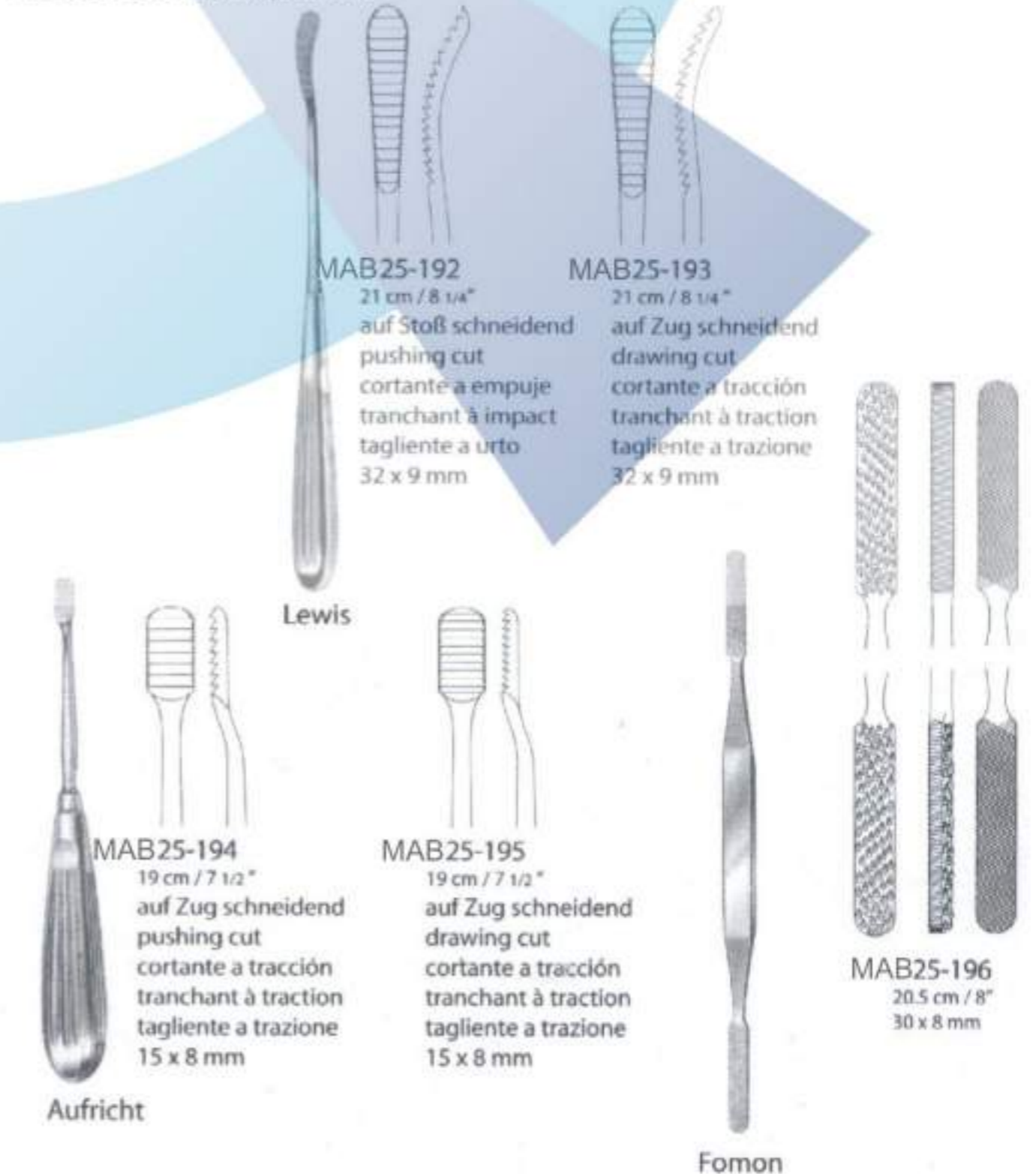



Rhinologie . Rhinology . Rinologia  
 Nasenraspeln  
 Nasal Rasps  
 Escofinas nasales  
 Râpes nasales  
 Raspe nasali

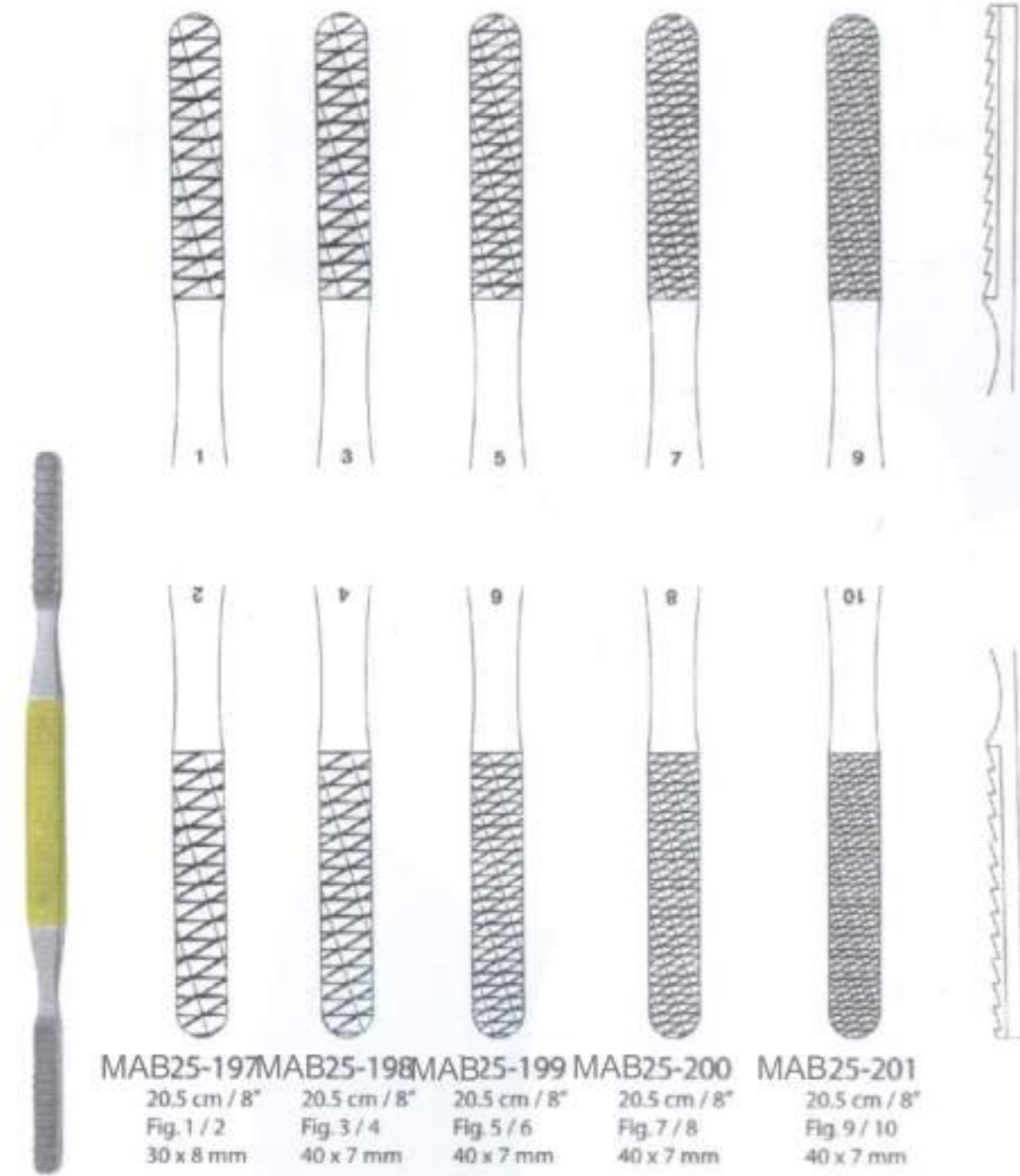

Fomon

Rhinologie . Rhinologie . Rinologia  
 Nasenhäkchen, Nasenhaken  
 Nasal Hooks, Nasal Retractors  
 Ganchitos nasales, Separadores nasales  
 Crochets nasaux, Ecarteurs nasaux  
 Uncini nasali, Divaricatori nasali

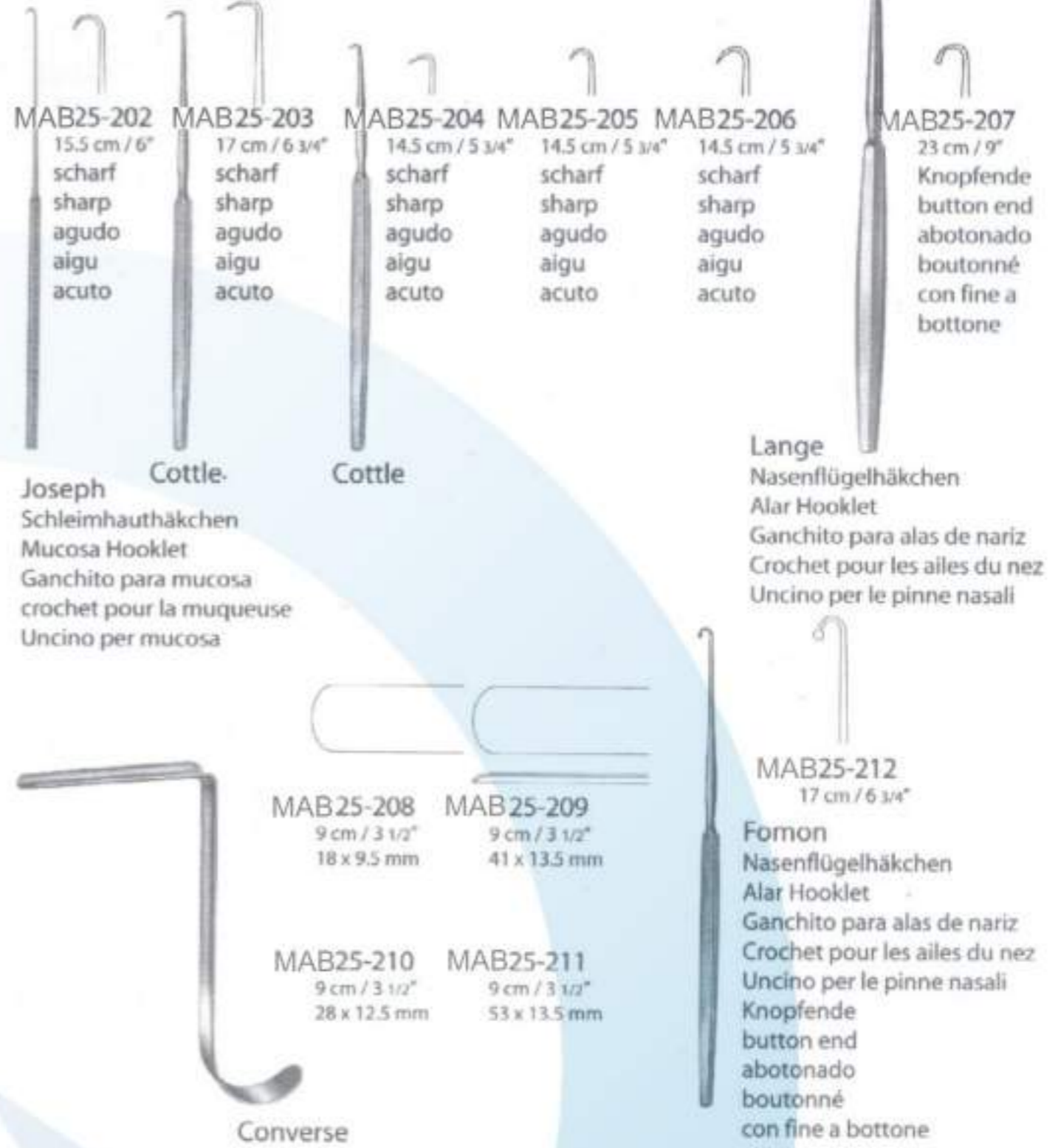

Rhinologie . Rhinology . Rinologia  
 Nasenhaken, Schleimhauthäkchen  
 Nasal Retractors, Mucosa Hooklets  
 Separadores nasales, Ganchitos para mucosa  
 Ecarteurs nasaux, Crochets pour la muqueuse  
 Divaricatori casali, Uncini per mucosa



Rhinologie . Rhinologie . Rinologia  
 Nasenflügelhäkchen, Nasenhaken  
 Alar Hooklets, Nasal Retractors  
 Ganchitos para alas de nariz, Separadores nasales  
 Crochets pour les ailes du nez, Ecarteurs nasaux  
 Uncini per le pinne nasali, Divaricatori nasali

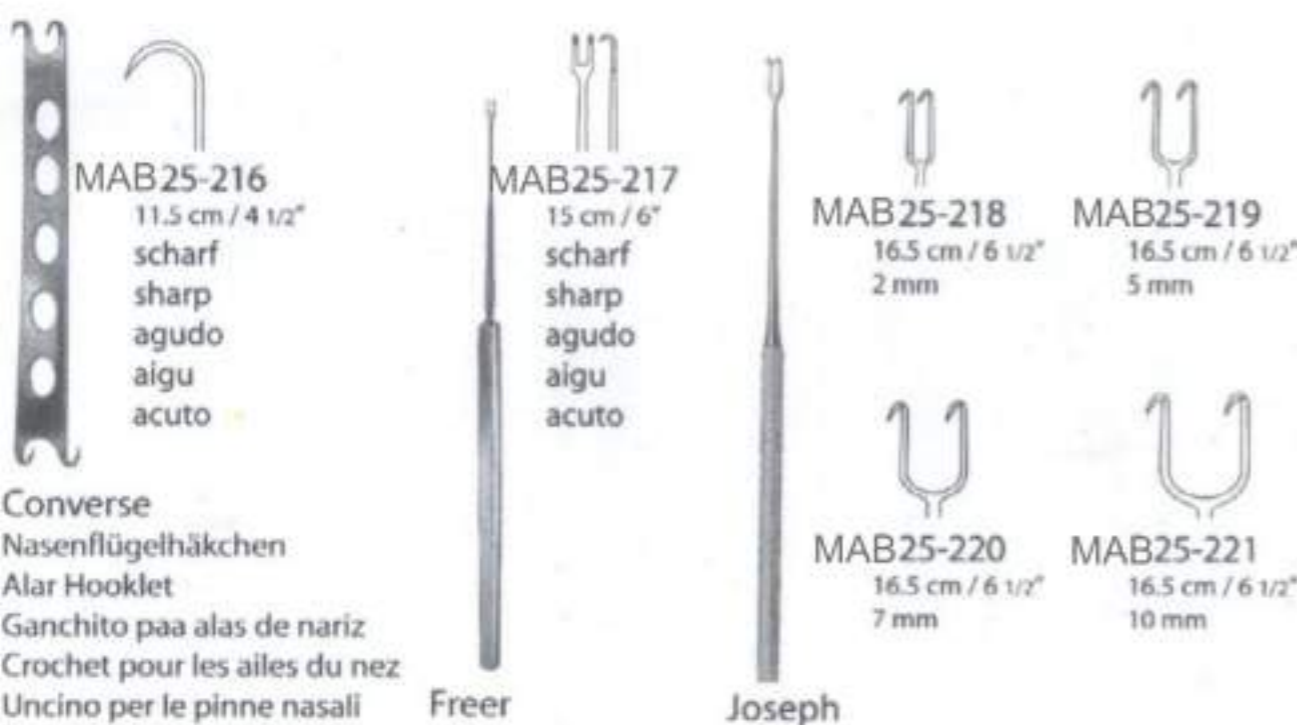
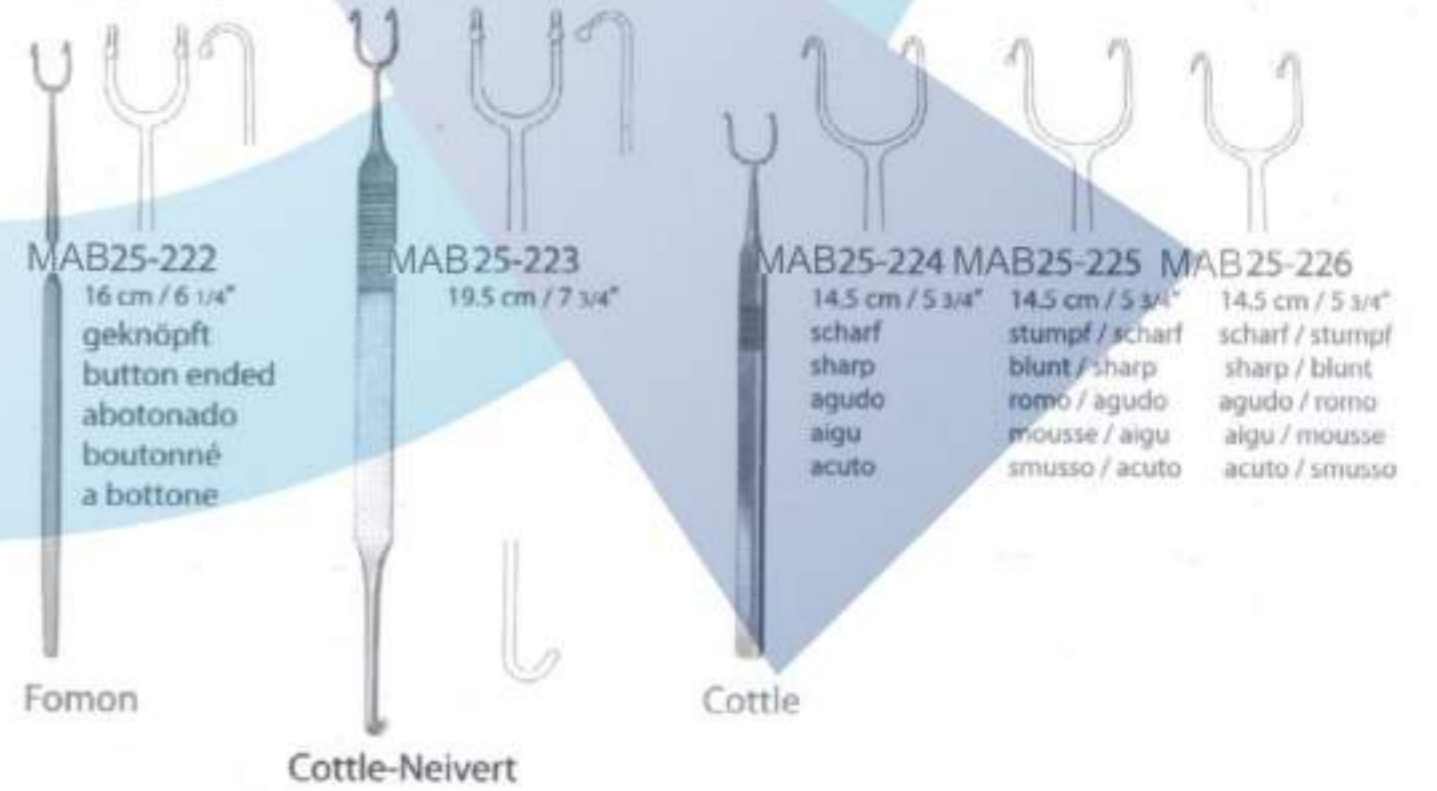



Rhinologie . Rhinology . Rinología  
 Rhinoplastik-Messer  
 Rhinoplastic Knives  
 Cuchillos para rinoplástica  
 Couteaux pour plastie du nez  
 Bisturi per plastica nasale

Rhinologie . Rhinologie . Rinologia  
 Septummesser, Schwingmesser  
 Septum Knives, Swivel Knives  
 Cuchillos para tabique nasal  
 Bistouris pour la cloison nasale  
 Bisturi per il setto nasale

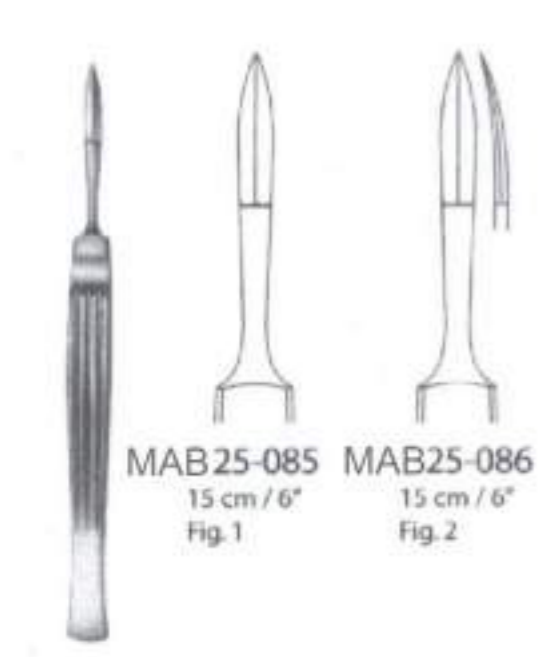

MAB25-085 15 cm / 6" Fig.1  
 MAB25-086 15 cm / 6" Fig.2

Joseph



MAB25-087 16.5 cm / 6 1/2"

Fomon



MAB25-091 16.5 cm / 6 1/2"

Mukosamesser  
 Mucosa Knife  
 Cuchillo para mucosa  
 Couteau pour muqueuse  
 Bisturi per mucosa

Freer



MAB25-092 19 cm / 7 1/2"

Freer



MAB25-093 19 cm / 7 1/2"

Freer



MAB25-088 16 cm / 6 1/4"

Converse



MAB25-089 15 cm / 6"

Joseph



MAB25-090 14 cm / 5 1/2"

Cottle



MAB25-094 21 cm / 8 1/4" 3.0 mm

Ballenger



MAB25-095 21 cm / 8 1/4" 4.0 mm



MAB25-096 21 cm / 8 1/4" 5.0 mm



MAB25-097 20 cm / 8" 3.0 mm

Ballenger



MAB25-098 20 cm / 8" 4.0 mm



MAB25-099 20 cm / 8" 5.0 mm

Rhinologie . Rhinology . Rinologia  
 Septumelevatorien  
 Septum Elevators  
 Elevadores para tabique nasal  
 Elévateurs pour la cloison nasale  
 Elevatori per il setto nasale

Rhinologie . Rhinologie . Rinologia  
 Septumelevatorien  
 Septum Elevators  
 Elevadores para tabique nasal  
 Elévateurs pour la cloison nasale  
 Elevatori per il setto nasale



MAB25-100 16.5 cm / 6 1/2"

Brünings  
 Septummesser  
 Septum Knife  
 Cuchillo para tabique nasal  
 Bistouri pour la cloison nasale  
 Bisturi per il setto nasale

McKenty



MAB25-101 15 cm / 6" 4 mm



MAB25-102 15 cm / 6" 5 mm

Halle



MAB25-103 16 cm / 6 1/4" 3.5 mm

Joseph



MAB25-104 16 cm / 6 1/4" 4 mm



MAB25-109 20.5 cm / 8" 4 / 4 mm

McKenty



MAB25-110 19 cm / 7 1/2" 6 / 6 mm

Ballenger-Hajek



MAB25-111 23.5 cm / 9 1/4" 5 x 5 mm

Cottle



MAB25-105 19 cm / 7 1/2" 5 mm  
 scharf / sharp / agudo / aigu / acuto

Freer



MAB25-106 19 cm / 7 1/2" 6 mm  
 stumpf / blunt / romo / mousse / smusso

Freer



MAB25-107 18.5 cm / 7 1/4" 5 / 5 mm  
 scharf / stumpf / sharp / blunt / agudo / romo / aigu / mousse / acuto / smusso

Freer



MAB25-108 20.5 cm / 8" 6 / 5 mm

Freer



MAB25-112 18 cm / 7" 4 / 4 mm

Killian



MAB25-113 23 cm / 9" 4.5 x 4.5 mm

Killian



MAB25-114 21.5 cm / 8 1/2" 4 x 4 mm

Pennington



Mund, Kiefer, Gesichtschirurgie  
 Oral Maxillo-Facial Surgery  
 Cirurgia oral y Maxilofacial  
 Chirurgie buccale et maxillo-faciale  
 Chirurgia maxillo-facciale

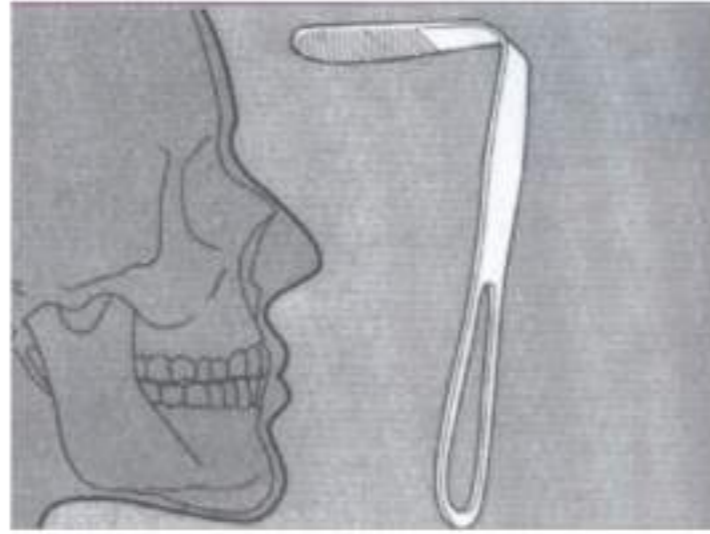

## MAB 26

Mund-, Kiefer-, Gesichtschirurgie . Oral Maxillo-Facial Surgery . Cirurgia oral y maxilofacial  
 Elevatorien, Transplantatstopfer  
 Elevators, Graft Packers  
 Elevadores, Atacadores de trasplantes  
 Elévateurs, Pousoirs pour transplantation  
 Elevatori, Turatori per innesti



Terry  
 17 cm / 6 3/4"  
 zur Alveolarlappenabhebung  
 for elevation of alveolar flaps  
 para la elevación de las aletas alveolares  
 pour élévation du lambeau alvéolaire  
 per la elevazione del lembo alveolare



Terry  
 Transplantatstopfer  
 Graft Packer  
 Atacador de trasplantes  
 Pousoir pour transplantation  
 Turatore per innesti



Transplantatstopfer  
 Graft Packer  
 Atacador de trasplantes  
 Pousoir pour tarsplantation  
 Turatore per innesti



Terry  
 18 cm / 7"  
 für subperiostale Tunnel  
 for subperiosteal tunnels  
 para túneles subperiósticos  
 pour tunnel subpériostale  
 per tunnel supperiostale

Mund-, Kiefer-, Gesichtschirurgie . Chirurgie buccale et maxillo-faciale . Chirurgia maxillo-facciale  
 Mund-, Kiefer-, Gesichtschirurgie . Oral Maxillo-Facial Surgery . Cirurgia oral y maxilofacial  
 Sinus-Lift-Küretten  
 Sinus Lift Curettes  
 Curetas para Sinus-lift  
 Curettes pour Sinus-lift  
 Curette per Sinus-lift

Mund-, Kiefer-, Gesichtschirurgie . Chirurgie buccale et maxillo-faciale . Chirurgia maxillo-facciale  
 Mund-, Kiefer-, Gesichtschirurgie . Oral Maxillo-Facial Surgery . Cirurgia oral y maxilofacial  
 Sinus-Lift-Küretten  
 Sinus Lift Curettes  
 Curetas para Sinus-lift  
 Curettes pour Sinus-lift  
 Curette per Sinus-lift





Mund-, Kiefer-, Gesichtschirurgie . Oral Maxillo-Facial Surgery . Cirugía oral y maxilofacial  
 Mundsperrer  
 Mouth Gags  
 Abrebocas  
 Ouvre-bouche  
 Apribocca

Mund-, Kiefer-, Gesichtschirurgie . Chirurgie buccale et maxillo-faciale . Chirurgia caxillo-facciale  
 Mundsperrer  
 Mouth Gags  
 Abrebocas  
 Ouvre-bouche  
 Apribocca



Heister  
 MAB 26-020  
 13 cm / 5"



Obwegeser  
 MAB26-021  
 11 cm / 4 1/4"



Molt  
 MAB26-022  
 11 cm / 4 1/4"



Molt  
 MAB26-023  
 13 cm / 5"



Denhart

MAB 26-024  
 13 cm / 5"  
 Backen  
 jaws  
 bocas  
 mors  
 branche  
 16 mm



Roser-König



MAB26-025  
 16 cm / 6 1/4"



MAB 26-026  
 20 cm / 8"



Jennings

MAB26-027 10.5 cm / 4"  
 MAB26-028 12.5 cm / 5"  
 MAB26-029 14.5 cm / 5 3/4"  
 MAB26-030 16.5 cm / 6 1/2"

Mund-, Kiefer-, Gesichtschirurgie . Chirurgie buccale et maxillo-faciale . Chirurgia maxillo-facciale  
 Lippen- u. Wangenhalter  
 Lip and Cheek Retractors  
 Separadores para labios y mejillas  
 Ecarteurs des lèvres et joues  
 Separatori per labbra e guancia

Mund-, Kiefer-, Gesichtschirurgie . Oral Maxillo-Facial Surgery . Cirugía oral y maxilofacial  
 Wangenhalter  
 Cheek Retractors  
 Separadores para mejilla  
 Ecarteurs des joues  
 Separatori per guancia



Martin-Simplex  
 MAB26-031  
 10.5 cm / 4"



MAB26-032  
 14 cm / 5 1/2"  
 Vestibulumhaken  
 Vestibulum Retractor  
 Separador para vestibulo  
 Ecarteur pour vestibulum  
 Separatore per vestibulo



Sternberg  
 MAB 26-033  
 14 cm / 5 1/2"  
 26 / 37 mm



Obwegeser

MAB26-034  
 12 cm / 4 3/4"



Bishop

MAB 26-035  
 13.5 cm / 5 1/4"  
 27 mm



Cawood-Minnesota

MAB 26-036  
 15 cm / 6"  
 20 mm



MAB26-037  
 14.5 cm / 5 3/4"  
 gefenstert  
 fenestrated  
 fenestrado  
 fenêtre  
 finestrato



Mund-, Kiefer-, Gesichtschirurgie . Chirurgie buccale et maxillo-faciale . Chirurgia maxillo-facciale

Zungendrucker  
Tongue Depressors  
Abajalenguas  
Abaisse-langue  
Abassalingua



MAB26-038  
15 cm / 6"  
72 x 23 mm

Hartmann



MAB26-039  
15 cm / 6"  
88 x 25 mm

Tobold



MAB26-040  
14.5 cm / 5 3/4"  
85 x 24 mm

Tobold



Wieder



MAB26-041  
14 cm / 5 1/2"  
36 mm

MAB26-042  
15 cm / 6"  
43 mm

Mund-, Kiefer-, Gesichtschirurgie . Oral Maxillo-Facial Surgery . Cirugía oral y maxilofacial

Zungenspatel  
Tongue Spatulas  
Espátulas linguales  
Abaisse-langue  
Spatole per lingua



Doyen



MAB26-043  
13.5 cm / 5 1/4"  
24 / 30 mm



MAB26-044  
16 cm / 6 1/4"  
30 / 34 mm



MAB26-045  
19 cm / 7 1/2"  
19 / 15 mm

Brünings

Mund-, Kiefer-, Gesichtschirurgie . Chirurgie buccale et maxillo-faciale . Chirurgia maxillo-facciale

Zungenzangen  
Tongue Holding Forceps  
Pinzas tira-lengua  
Pinces tire-langue  
Pinze per lingua



MAB26-046  
17 cm / 6 3/4"  
Maul 24 x 27 mm  
Jaw 24 x 27 mm  
boca 24 x 27 mm  
mors 24 x 27 mm  
branche 24 x 27 mm

Collin



MAB26-047  
15 cm / 6"

Young



MAB26-048  
Gummipolster  
Rubber Inserts  
Bocas de goma  
Mors en caoutchouc  
Cuscino di gomma  
23 x 15 mm  
paar  
pair  
Par  
paire  
paio

Mund-, Kiefer-, Gesichtschirurgie . Oral Maxillo-Facial Surgery . Cirugía oral y maxilofacial

Extraorale Retraktoren  
Extra Oral Retractors  
Separadores extra orales  
Rétracteurs extra-oraux  
Separatori extraorali



MAB26-049  
22 cm / 8 3/4"  
9.5 mm / 16 mm  
konkaves Blatt, mit stark  
aufgebogenem Ende  
concave blade, fully bent tip  
hoja concava, fuertemente  
curva  
lame concave, courbé  
énormement  
lama concava, fortemente  
curva



MAB26-050  
25.5 cm / 10"  
9.5 mm / 16 mm  
konkaves Blatt, mit stark  
aufgebogenem Ende  
concave blade, fully bent tip  
hoja concava, fuertemente  
curva  
lame concave, courbé  
énormement  
lama concava, fortemente  
curva

Mund-, Kiefer-, Gesichtschirurgie . Oral Maxillo-Facial Surgery . Cirugía oral y maxilofacial

Intraorale Retraktoren  
Intra Oral Retractors  
Separadores intra orales  
Rétracteurs intra-oraux  
Separatori intraorali



MAB26-053  
21 cm / 8 1/4"  
26.5 / 16 mm  
rechts  
right  
derecho  
droite  
destra



MAB26-054  
21 cm / 8 1/4"  
26.5 / 16 mm  
links  
left  
izquierdo  
gauche  
sinistra



MAB26-055  
24.5 cm / 9 3/4"  
26.5 / 16 mm  
rechts  
right  
derecho  
droite  
destra



MAB26-056  
24.5 cm / 9 3/4"  
26.5 / 16 mm  
links  
left  
izquierdo  
gauche  
sinistra

Mund-, Kiefer-, Gesichtschirurgie . Chirurgie buccale et maxillo-faciale . Chirurgia maxillo-facciale

Intraorale Retraktoren  
Intra Oral Retractors  
Separadores intra orales  
Rétracteurs intra-oraux  
Separatori intraorali



MAB26-051  
23 cm / 9"  
25.5 mm  
für LeFort Osteotomie  
for LeFort osteotomies  
para osteotomías según LeFort  
pour ostéotomie selon LeFort  
per osteotomie sec. LeFort



MAB26-052  
27 cm / 10 3/4"  
25.5 mm  
für LeFort Osteotomie  
for LeFort osteotomies  
para osteotomías según LeFort  
pour ostéotomie selon LeFort  
per osteotomie sec. LeFort

Mund-, Kiefer-, Gesichtschirurgie . Oral Maxillo-Facial Surgery . Cirugía oral y maxilofacial

Intraorale Retraktoren  
Intra Oral Retractors  
Separadores intra orales  
Rétracteurs intra-oraux  
Separatori intraorali



MAB26-057  
25 cm / 9 3/4"  
12.5 / 27 mm  
L&M, für vertikale Osteotomie  
L&M, for vertical osteotomy  
L&M, para osteotomia vertical  
L&M, pour ostéotomie verticale  
L&M, per osteotomia verticale



MAB26-058  
28 cm / 11"  
12.5 / 27 mm  
L&M, für vertikale Osteotomie  
L&M, for vertical osteotomy  
L&M, para osteotomia vertical  
L&M, pour ostéotomie verticale  
L&M, per osteotomia verticale



MAB26-059  
22 cm / 8 3/4"  
14.5 mm  
Shea  
Mehrzweck-Retraktor  
Multi Purpose Retractor  
Separador de aplicaciones varias  
Rétracteurs pour applications différentes  
Separatori multuso



Mund-, Kiefer-, Gesichtschirurgie . Oral Maxillo-Facial Surgery . Cirugía oral y maxilofacial  
**Weichteilhaken**  
**Soft Tissue Retractors**  
**Separadores para partes blandas**  
**Crochets pour parties molles**  
**Separatori per tessuti molli**



Obwegeser

Mund-, Kiefer-, Gesichtschirurgie . Oral Maxillo-Facial Surgery . Cirugía oral y maxilofacial  
**Kinnhalter, Progenierinnen**  
**Chin Retractor, Channel Retractors**  
**Gancho de mentón, Separadores mandibulares**  
**Fixe-mentom, Ecarteurs mandibulaires**  
**Guancio per mento, Separatori mandibulari**

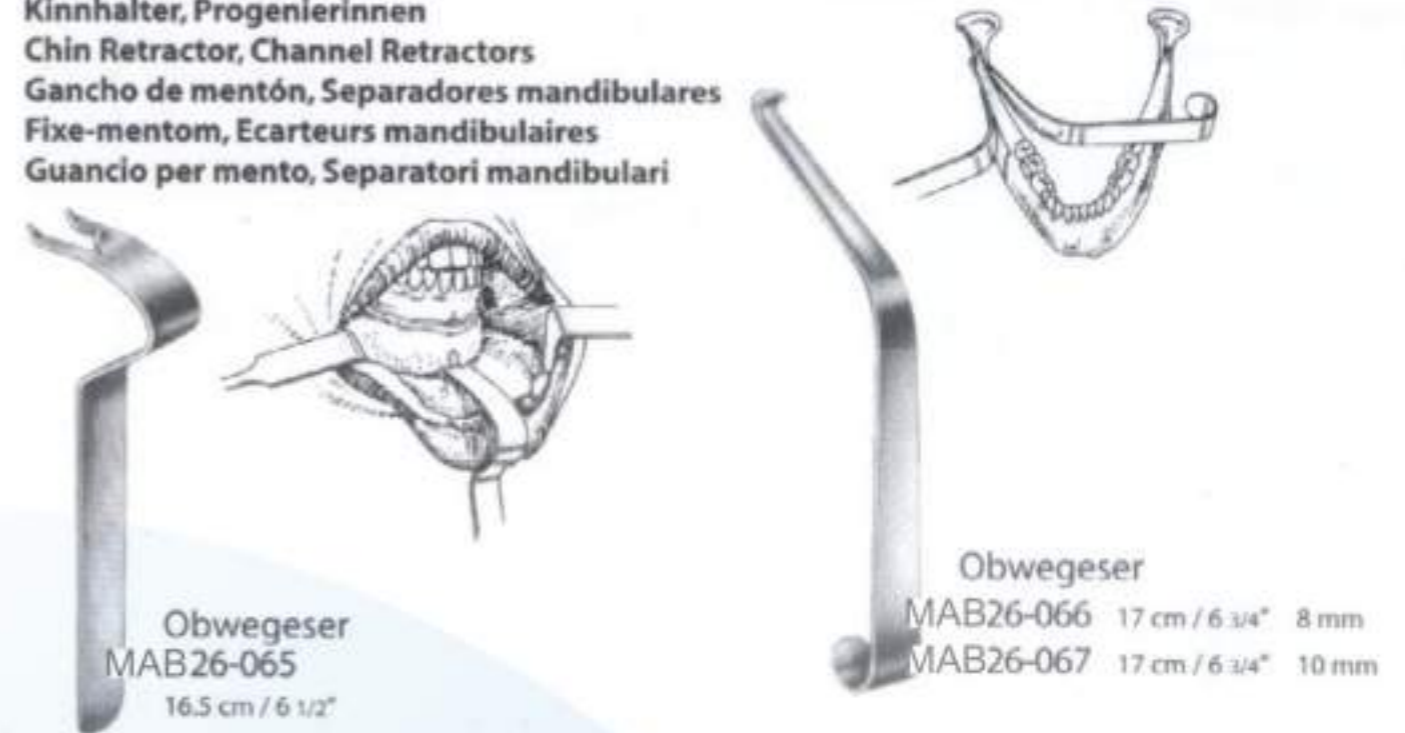

Obwegeser

Mund-, Kiefer-, Gesichtschirurgie . Chirurgie buccale et maxillo-faciale . Chirurgia maxillo-facciale  
**Ramushaken**  
**Ramus Retractors**  
**Separadors para el ramo**  
**Ecarteurs pour ramus**  
**Separatore per ramo**

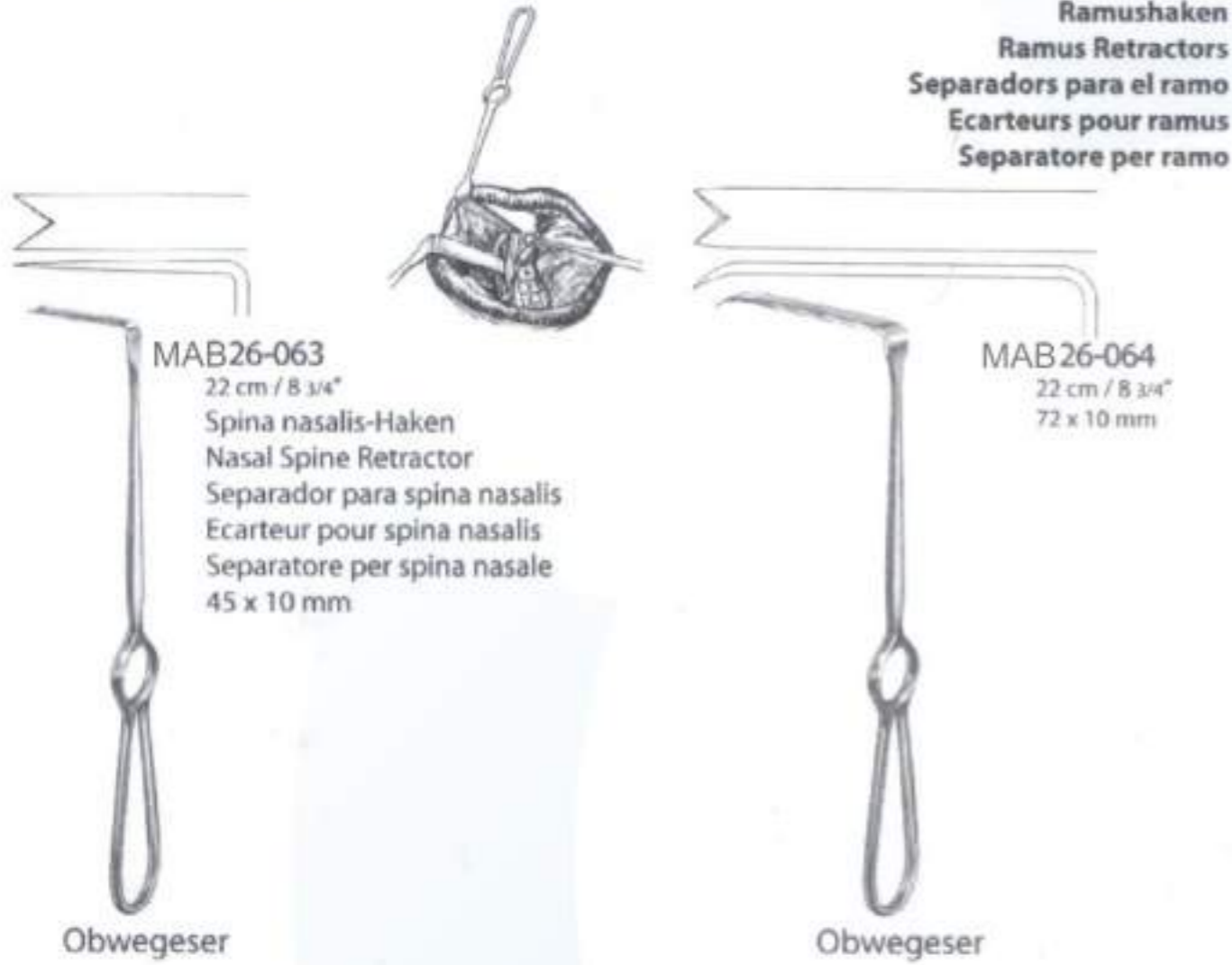

Obwegeser

Obwegeser

Mund-, Kiefer-, Gesichtschirurgie . Chirurgie buccale et maxillo-faciale . Chirurgia maxillo-facciale  
**Progeniehaken**  
**Progeny Retractor**  
**Separadors para progenismo**  
**Crochets de progenie**  
**Separatori per progenismo**

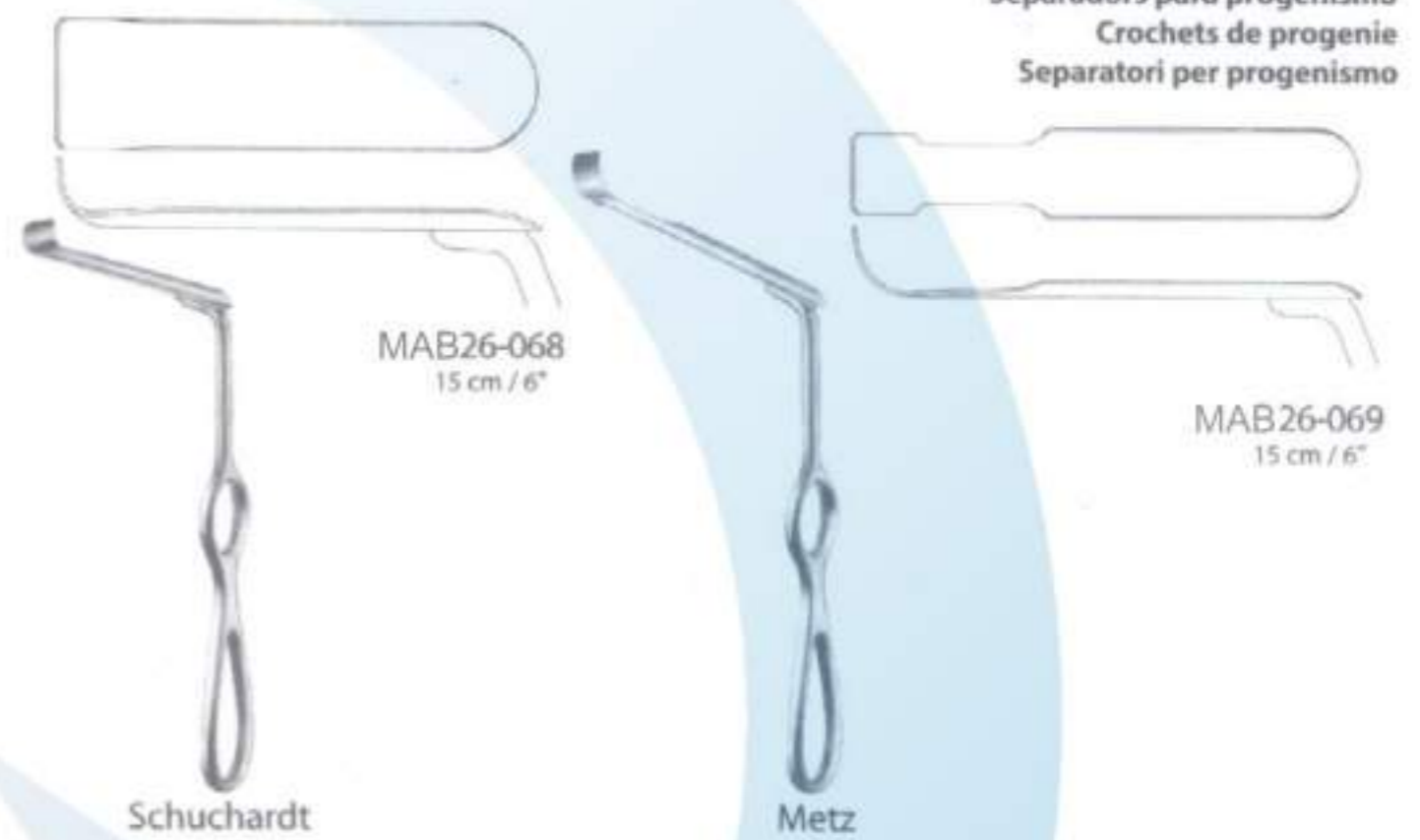

Schuchardt

Metz

Mund-, Kiefer-, Gesichtschirurgie . Oral Maxillo-Facial Surgery . Cirugía oral y maxilofacial  
**Wundhaken, Raspatorien**  
**Retractors, Periosteal Elevators**  
**Separadores, Legras**  
**Ecarteurs, Rugines-raspatoires**  
**Divaricatori, Elevatori per periosteo**

Mund-, Kiefer-, Gesichtschirurgie . Chirurgie buccale et maxillo-faciale . Chirurgia maxillo-facciale  
**Raspatorien**  
**Periosteal Elevators**  
**Legras**  
**Rugines-raspatoires**  
**Elevatori per periosteo**

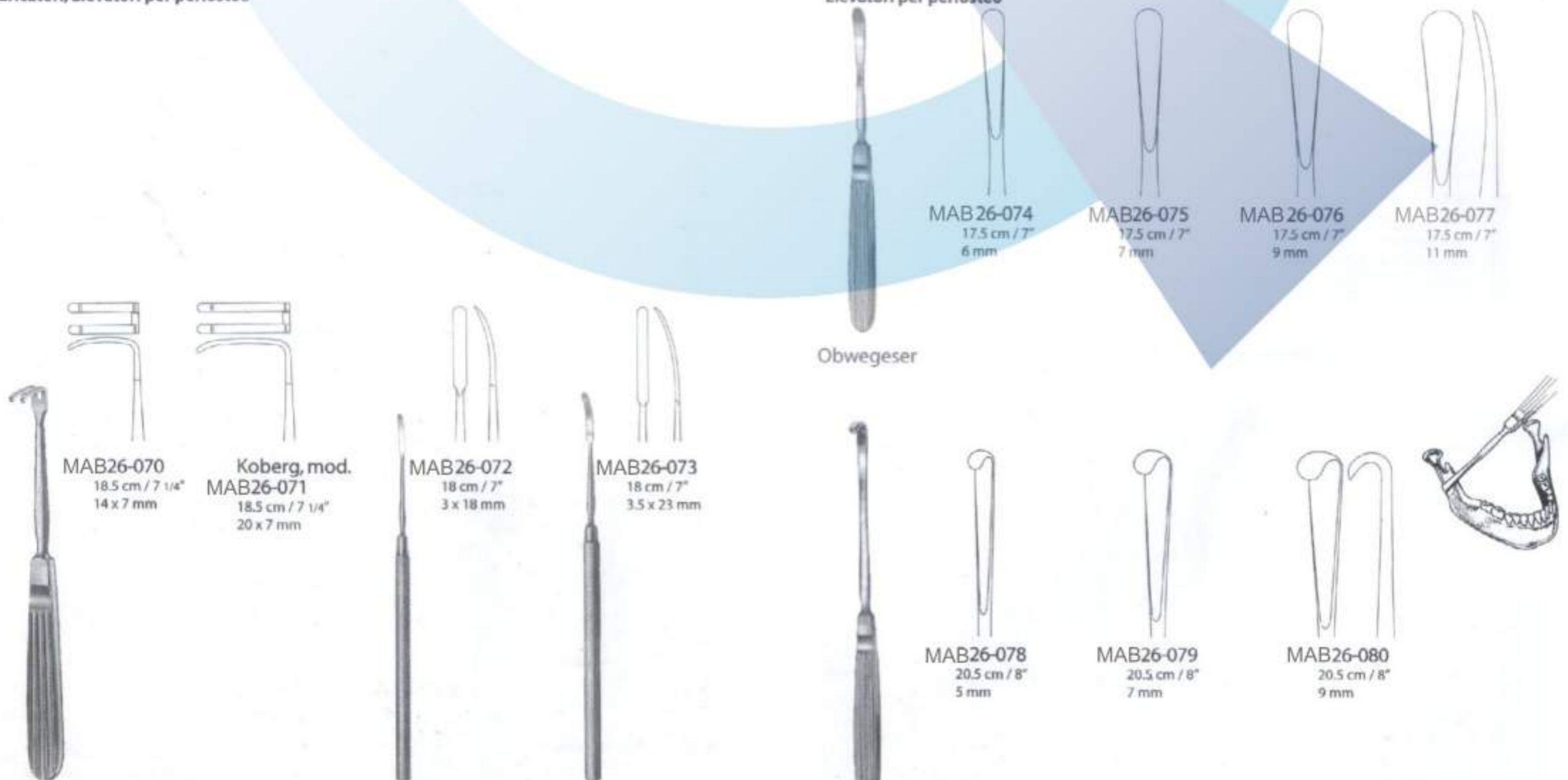

Obwegeser

Obwegeser



Mund-, Kiefer-, Gesichtschirurgie . Oral Maxillo-Facial Surgery . Cirugía oral y maxilofacial  
 Raspatorien, Elevatorien  
 Periosteal Elevators, Elevators  
 Legras, Elevadores  
 Rugines-raspatoires, Elévateurs  
 Elevatori per periosteio, Elevatori

Mund-, Kiefer-, Gesichtschirurgie . Oral Maxillo-Facial Surgery . Cirugía oral y maxilofacial  
 Drahtpositionierer, Drahtbogen  
 Wire pushers, Arch Bar  
 Empujadores de alambres, Arco de alambre  
 Outil de positionnement, Arc de fis  
 Posizionatori per filo, Arco di filo



Mund-, Kiefer-, Gesichtschirurgie . Chirurgie buccale et maxillo-faciale . Chirurgia maxillo-facciale  
 Repositionszangen  
 Disimpaction forceps  
 Pinzas para reposición  
 Pinces de reposition  
 Pinze per riduzione

Mund-, Kiefer-, Gesichtschirurgie . Oral Maxillo-Facial Surgery . Cirugía oral y maxilofacial  
 Zygoma-Elevatorien, Wundhaken  
 Zygoma Elevators, Retractors  
 Elevadores cigomáticos, Separadores  
 Elévateurs zygomatiques, Ecarteurs  
 Elevatori per zigomo, Divaricatori

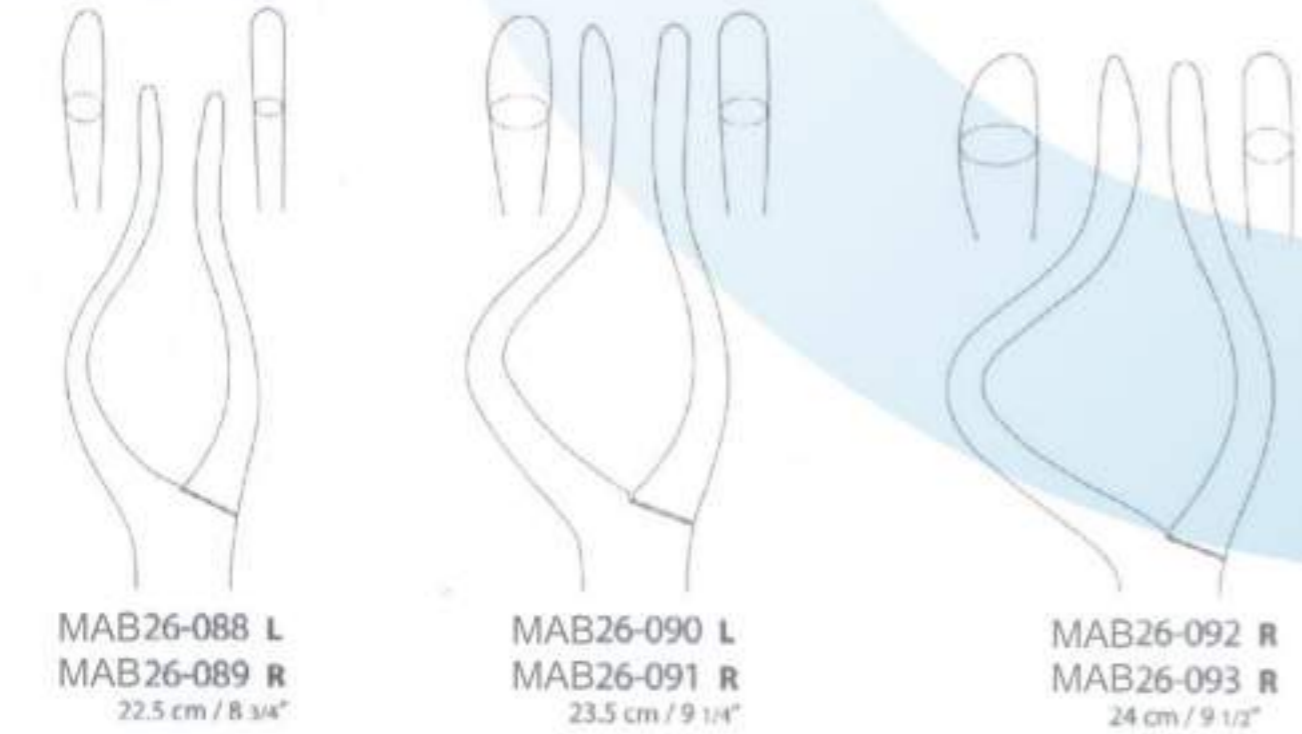



Mund-, Kiefer-, Gesichtschirurgie . Oral Maxillo-Facial Surgery . Cirugía oral y maxilofacial

Knochenhaltezaugen  
Bone Holding Forceps  
Pinzas para huesos  
Pincers pour os  
Pinze per ossa

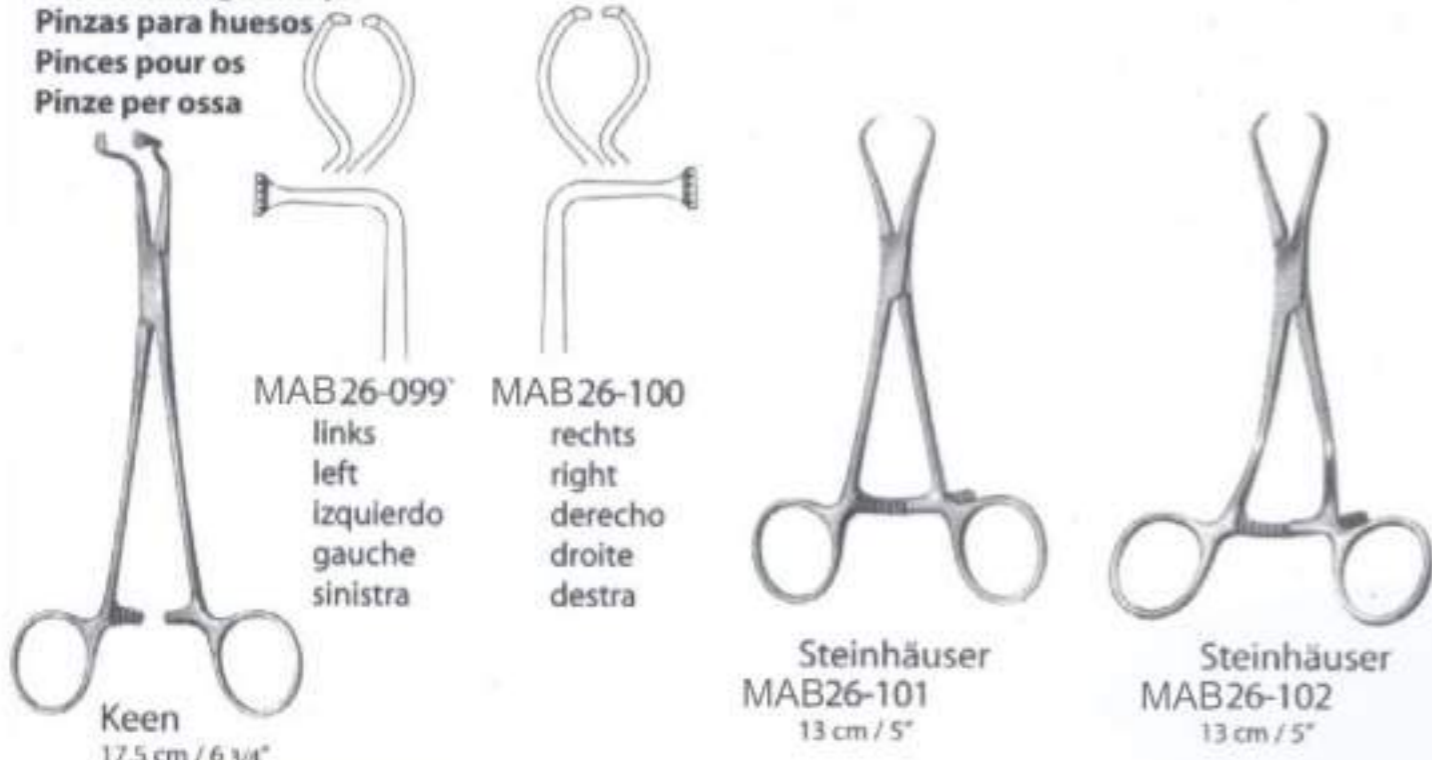

Mund-, Kiefer-, Gesichtschirurgie . Oral Maxillo-Facial Surgery . Cirugía oral y maxilofacial

LeFort I-Haken, Sinushaken  
LeFort I Retractors, Sinus Lift Retractors  
Ganchos de LeFort I, Ganchos para seno  
Crochets de LeFort I, Crochets pour sinus  
Divaricatori per LeFort I, Divaricatori per seno

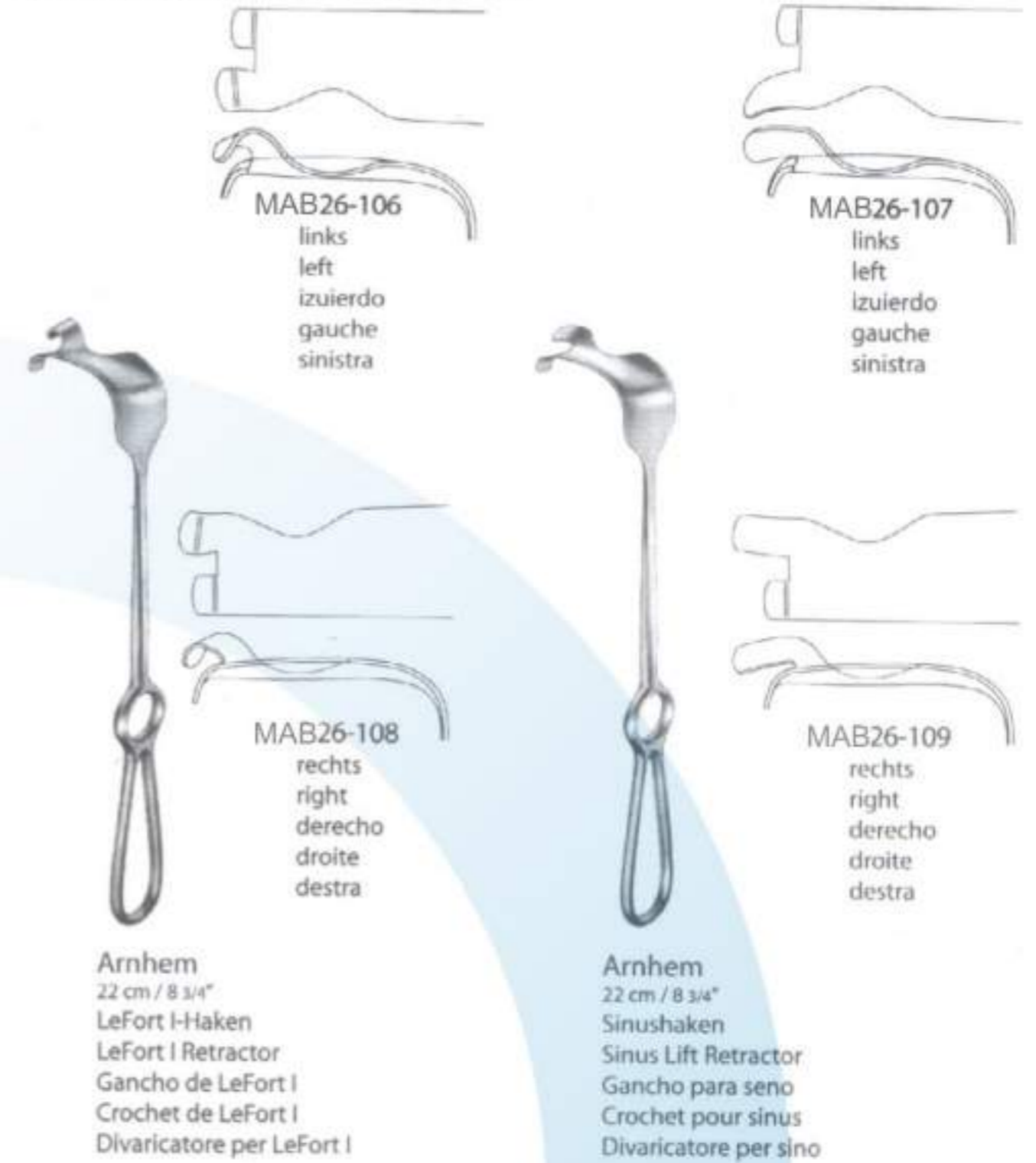

Mund-, Kiefer-, Gesichtschirurgie . Chirurgie buccale et maxillo-faciale . Chirurgia maxillo-facciale

Knochenhaltezaugen  
Bone Holding Forceps  
Pinzas para huesos  
Pincers pour os  
Pinze per ossa

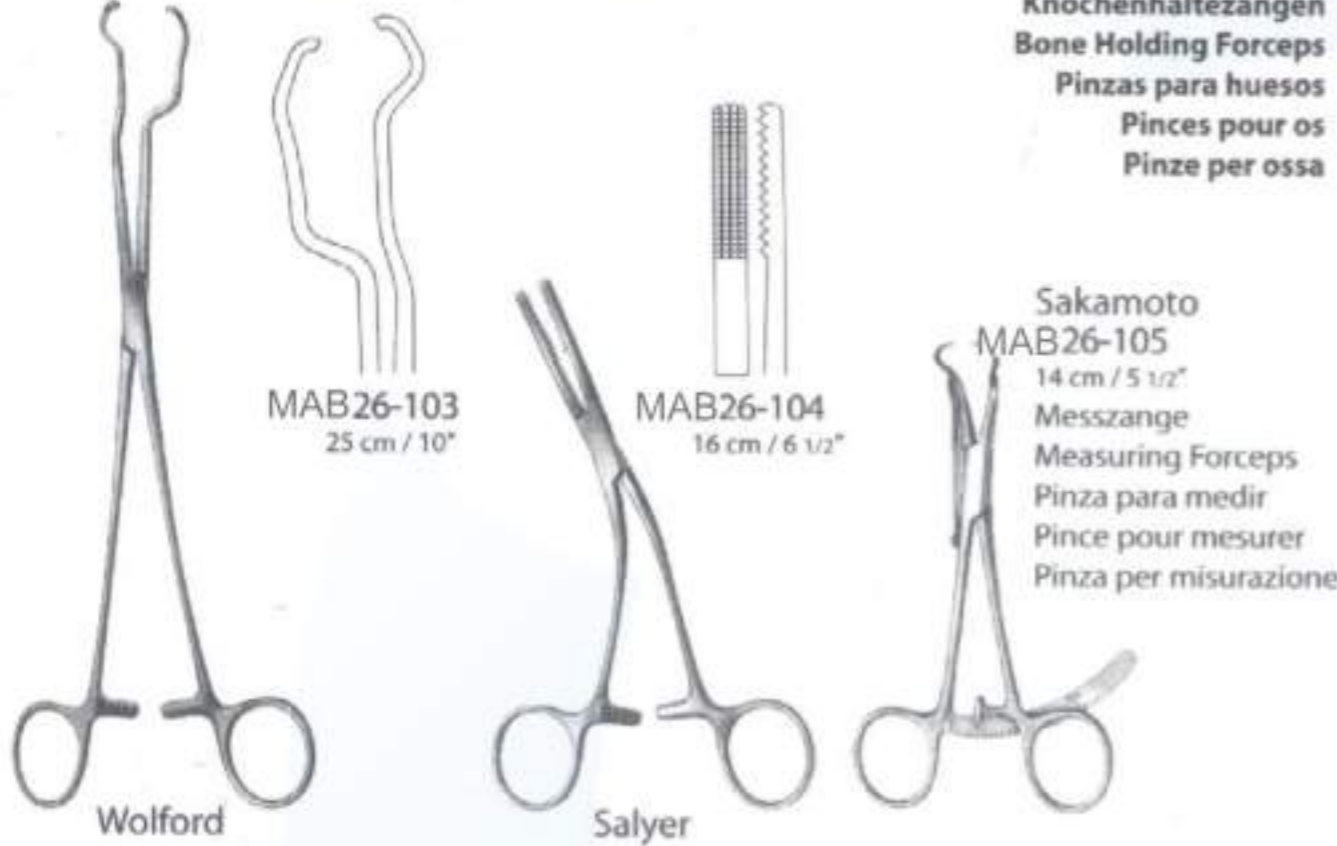

Mund-, Kiefer-, Gesichtschirurgie . Chirurgie buccale et maxillo-faciale . Chirurgia maxillo-facciale

Osteotome  
Osteotomes  
Osteótomos  
Ostéotomes  
Osteotomi

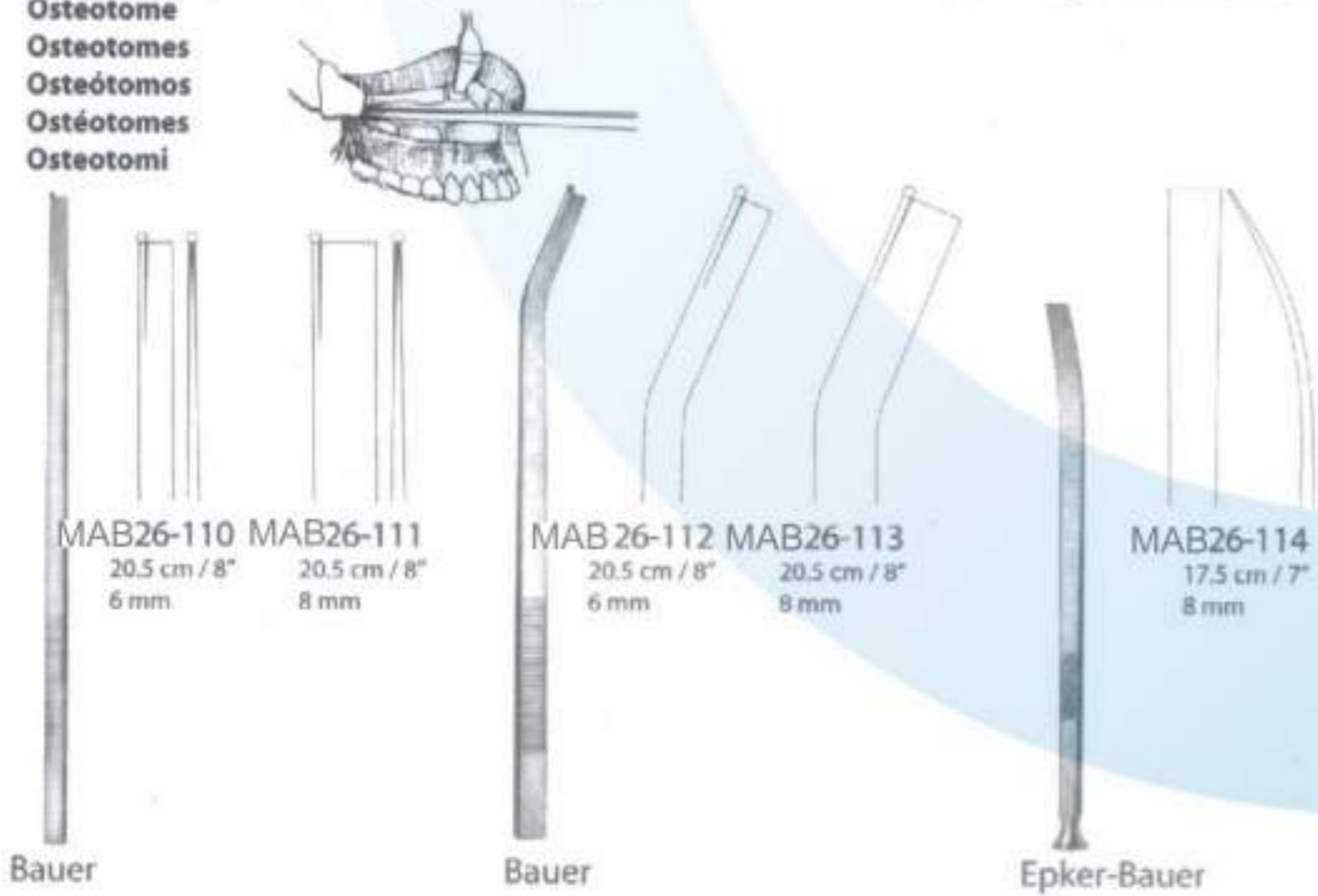

Mund-, Kiefer-, Gesichtschirurgie . Chirurgie buccale et maxillo-faciale . Chirurgia maxillo-facciale

Osteotome  
Osteotomes  
Osteótomos  
Ostéotomes  
Osteotomi

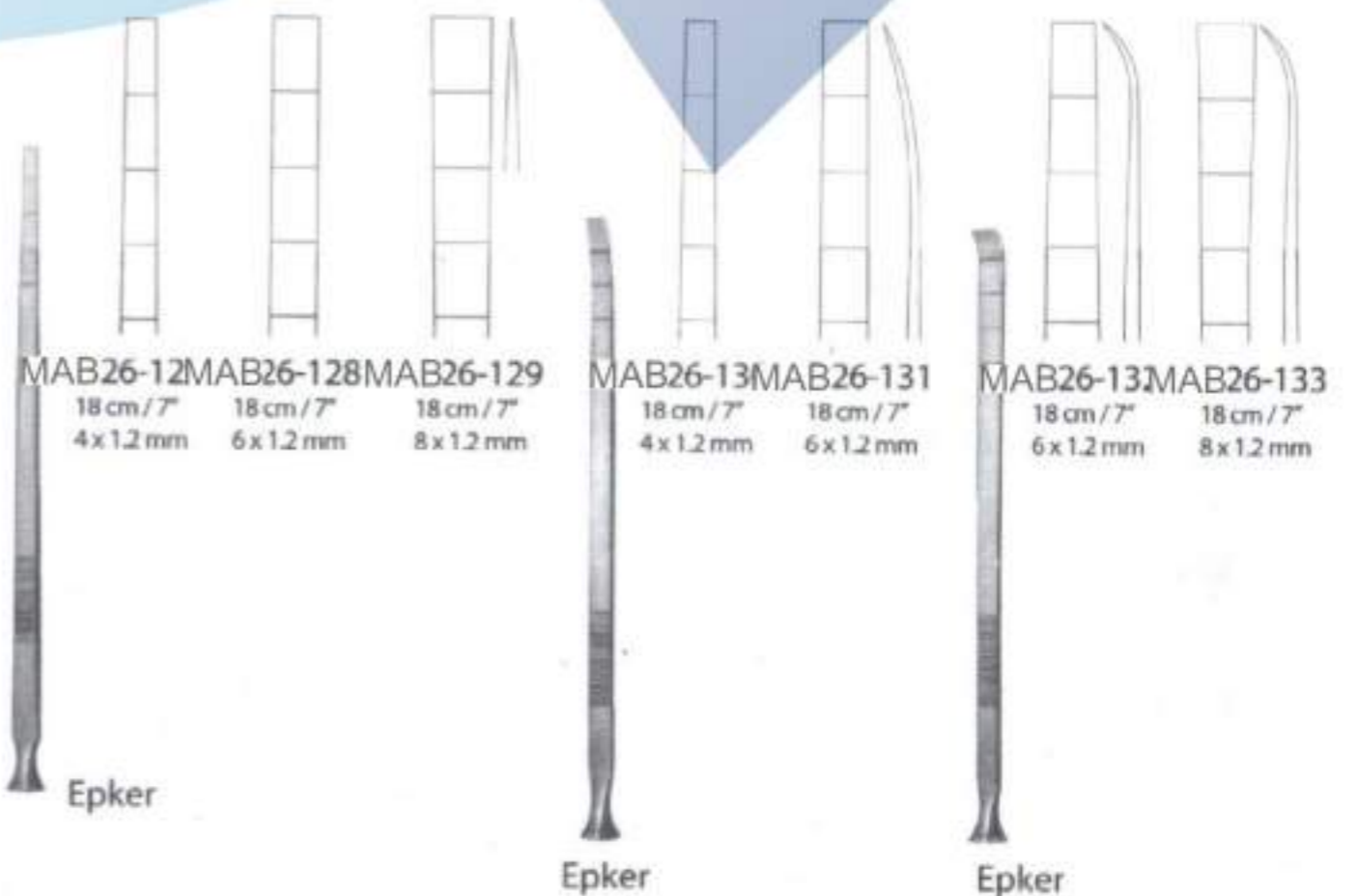
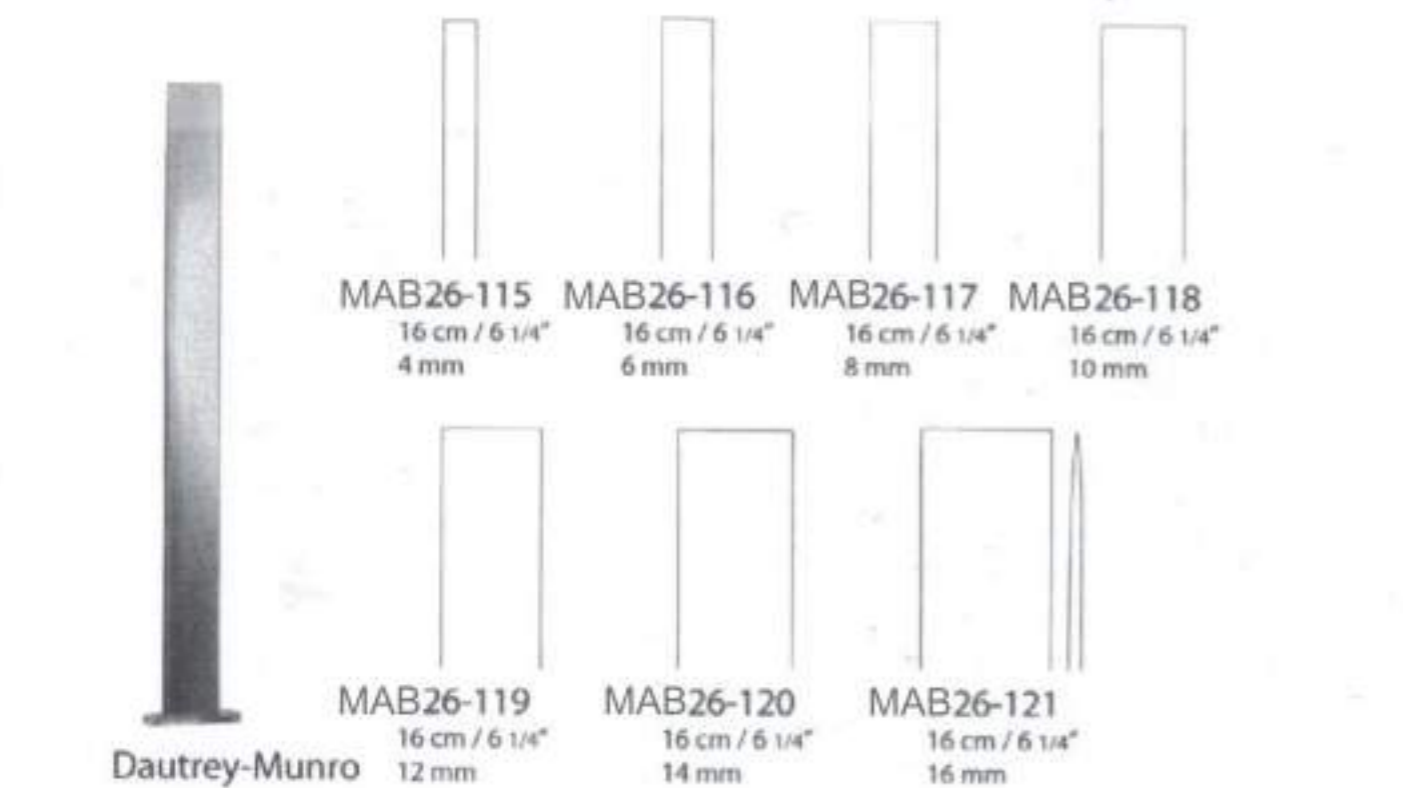



Mund-, Kiefer-, Gesichtschirurgie . Oral Maxillo-Facial Surgery . Cirugía oral y maxilofacial

Ramushaken  
Ramus Retractors  
Separadores de rama  
Ecarteurs pour ramus  
Separatori per ramo

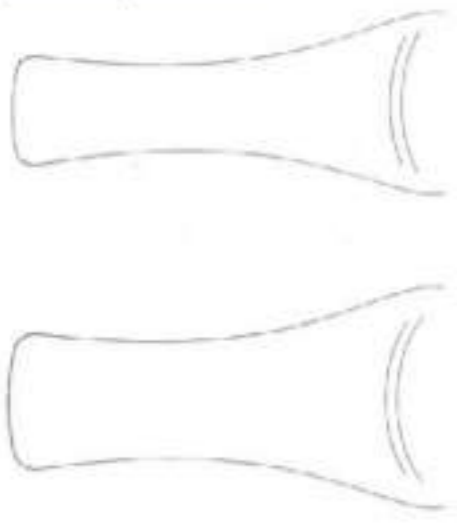

MAB26-134  
16 cm / 6 1/4"

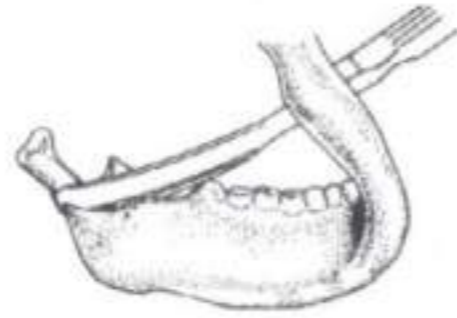

MAB26-135  
19.5 cm / 7 3/4"  
rechts  
right  
derecho  
droite  
destra

MAB26-136  
19.5 cm / 7 3/4"  
links  
left  
izquierdo  
gauche  
sinistra



Hargis  
Lippen- u. Wangenhalter  
Lip and Cheek Retractors  
Separadores para labios y mejillas  
Ecarteurs pour lèvres et joues  
Separatori per labbra e guancia

Mund-, Kiefer-, Gesichtschirurgie . Oral Maxillo-Facial Surgery . Cirugía oral y maxilofacial

Unterkieferkörperperhaken, Vorderrandstripper  
Mandibular Body Retractor, Anterior Border Stripper  
Separador para el cuerpo mandibular, Separador para el borde anterior  
Ecarteur pour corps mandibulaire, Ecarteur pour le bord antérieur  
Separatore per il corpo mandibulare, Separatore per il bordo anteriore



MAB26-137  
18 cm / 7"

Hargis

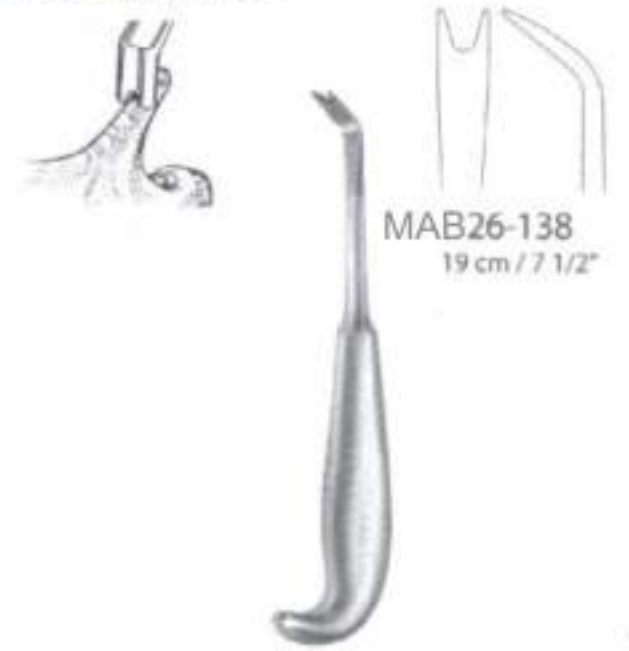

MAB26-138  
19 cm / 7 1/2"

Hargis

Mund-, Kiefer-, Gesichtschirurgie . Chirurgie buccale et maxillo-faciale . Chirurgia maxillo-facciale

Raspatorien  
Periosteal Elevators  
Legras  
Rugine-raspatoire  
Elevatori per periosteo



MAB26-139  
23 cm / 9"  
6.5 mm  
rechts  
right  
derecho  
droite  
destra

MAB26-140  
23 cm / 9"  
9 mm  
rechts  
right  
derecho  
droite  
destra

MAB26-141  
23 cm / 9"  
6.5 mm  
links  
left  
izquierdo  
gauche  
sinistra

MAB26-142  
23 cm / 9"  
9 mm  
links  
left  
izquierdo  
gauche  
sinistra

Hargis

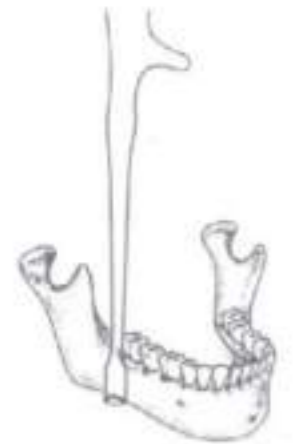

Mund-, Kiefer-, Gesichtschirurgie . Chirurgie buccale et maxillo-faciale . Chirurgia maxillo-facciale

Piriformis-Haken, Pterygoideus-Osteotom  
Periform Rim Retractor, Pterygoid Osteotome  
Gancho piriforme, Osteótomo pterigoideo  
Crochet pour la fosse piriforme, Ostéotome ptérygoïde  
Divaricatore per piriforme, Osteotomo per pterigoideo



MAB26-143  
18.5 cm / 7 1/4"

Hargis



MAB26-144  
22 cm / 8 3/4"

Hargis

Mund-, Kiefer-, Gesichtschirurgie . Oral Maxillo-Facial Surgery . Cirugía oral y maxilofacial

Sagittalspreizer, Spreizzange  
Sagittal Split Separators, Ramus Separator  
Separadores sagitales, Pinza para separar la rama  
Ecarteurs sagitaux, Pince pour separer ramus  
Separatori sagittali, Pinza per separare il ramo



Mund-, Kiefer-, Gesichtschirurgie . Oral Maxillo-Facial Surgery . Cirugía oral y maxilofacial

Knochenfassklemme  
Bone Holding Forceps  
Pinza para coger huesos  
Pince pour saisir os  
Afferratoio per ossa

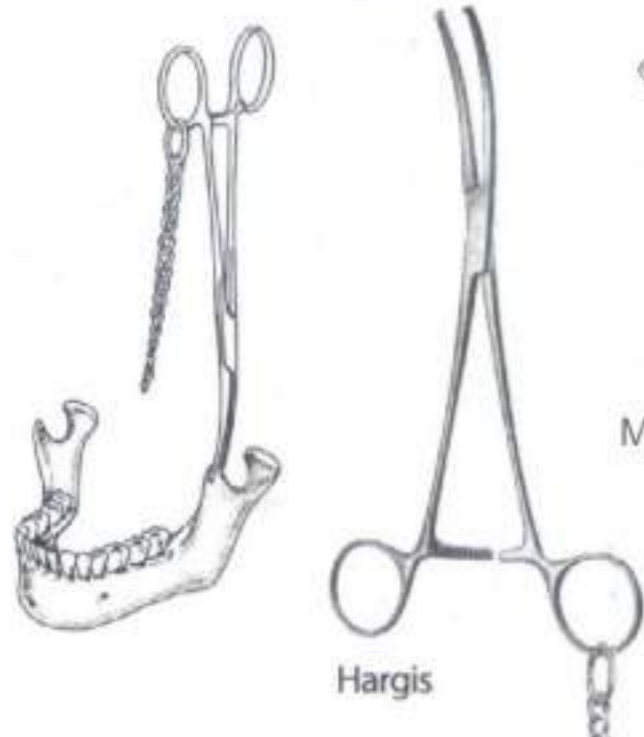

MAB26-145  
19 cm / 7 1/2"  
1:2  
mit Kette  
with chain  
con cadena  
avec chaîne  
con catena

Hargis

Hargis  
MAB26-146  
Kette, allein  
Retractor Chain, only  
cadena, suelta  
chaîne, seule  
catena, sola

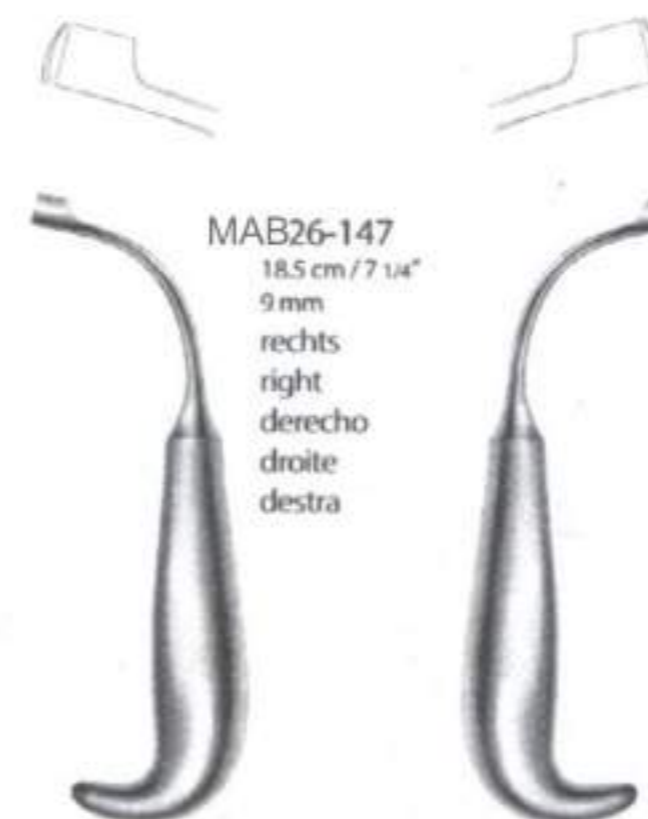

MAB26-147  
18.5 cm / 7 1/4"  
9 mm  
rechts  
right  
derecho  
droite  
destra

Smith

MAB26-148  
18.5 cm / 7 1/4"  
9 mm  
links  
left  
izquierdo  
gauche  
sinistra

Smith



MAB26-149  
23.5 cm / 9 1/4"

Smith



Mund-, Kiefer-, Gesichtschirurgie . Chirurgie buccale et maxillo-faciale . Chirurgia maxillo-facciale  
 Mylohyoidesklemmen  
 Mylohyoid Muscle Clamps  
 Pinzas para el músculo miloideo  
 Clamp mylohyoidal  
 Pinze per muscolo miloideo

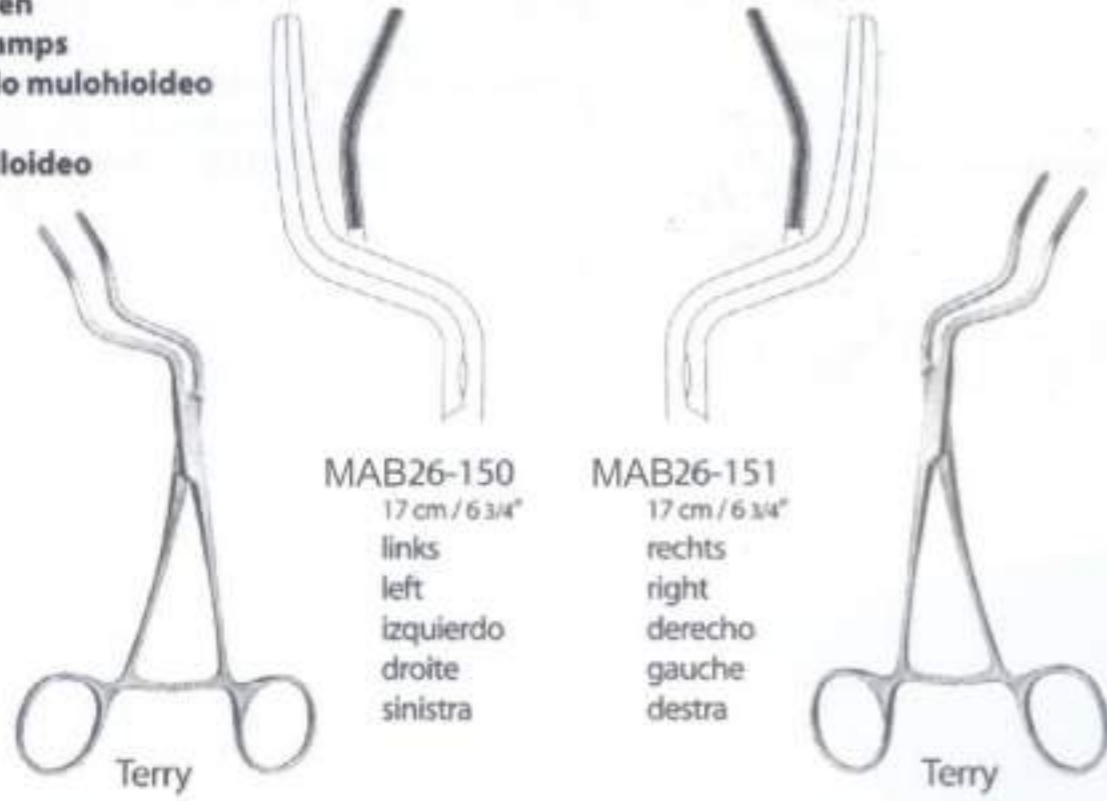

MAB26-150  
17 cm / 6 3/4"  
links  
left  
izquierdo  
droite  
sinistra

MAB26-151  
17 cm / 6 3/4"  
rechts  
right  
derecho  
gauche  
destra

Mund-, Kiefer-, Gesichtschirurgie . Chirurgie buccale et maxillo-faciale . Chirurgia maxillo-facciale  
 Drahteführinstrument, Septumosteotom, Ductushaken  
 Wire Introducer, Septal Osteotome, Duct Retractors  
 Introduttore de alambre, Osteótomo nasal, Ganchos para el conducto salivare  
 Introduteur pour fil, Ostéotome nasale, Crochet pour canal salivaire  
 Introduttore per filo, Osteotomo nasale, Divaricatori per condotto

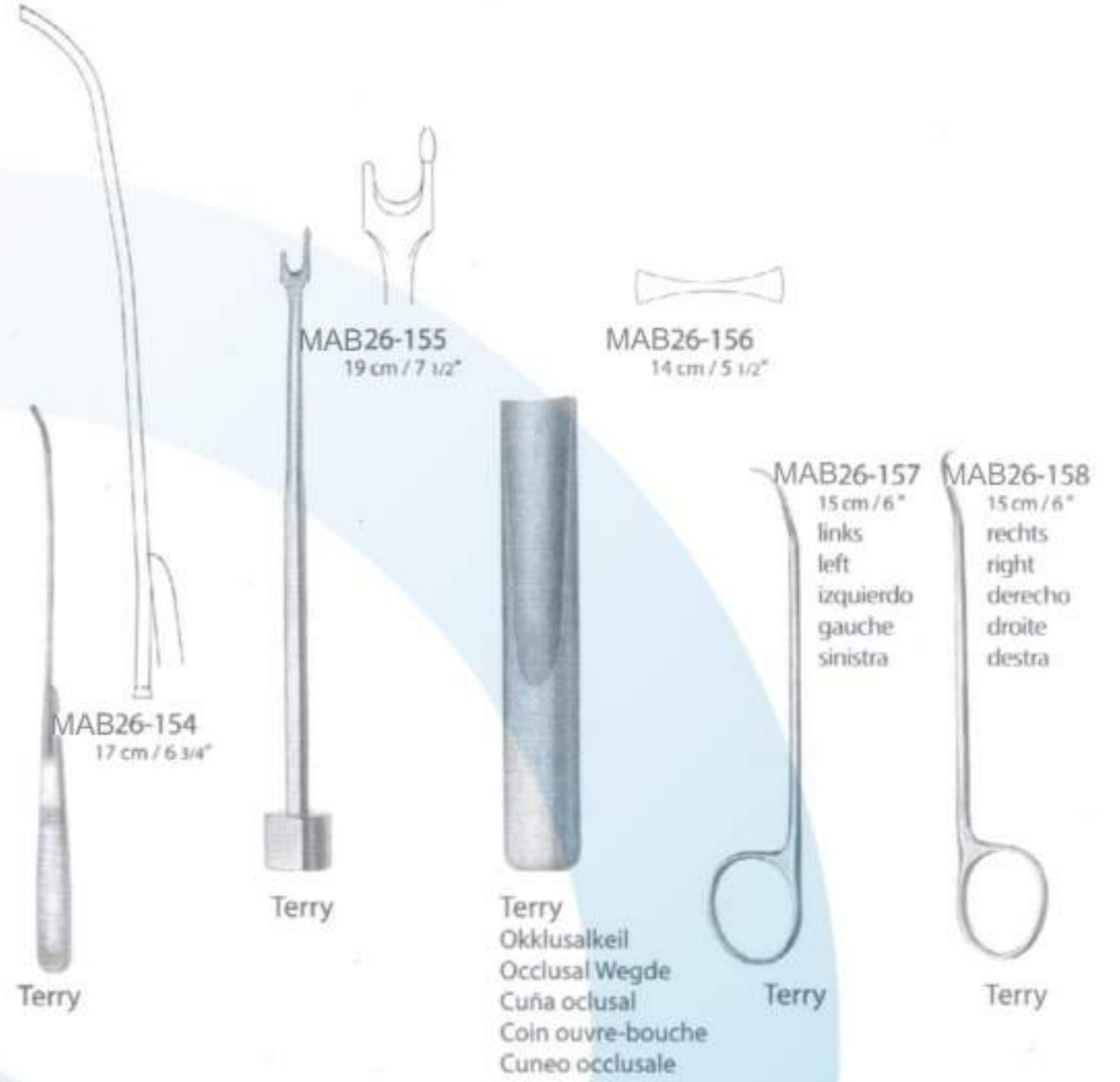

MAB26-155  
19 cm / 7 1/2"

MAB26-156  
14 cm / 5 1/2"

MAB26-157  
15 cm / 6"  
links  
left  
izquierdo  
gauche  
sinistra

MAB26-158  
15 cm / 6"  
rechts  
right  
derecho  
droite  
destra

MAB26-154  
17 cm / 6 3/4"

Mund-, Kiefer-, Gesichtschirurgie . Oral Maxillo-Facial Surgery . Cirugia oral y maxilofacial  
 Unterkieferhaken, Ramusschieber  
 Channel Retractors, Ramus Pusher  
 Gancho mandibular, Corredera de rama  
 Crochet mandibulaire, Manipulateur pour ramus  
 Divaricatore per mandibula, Posizionatore per ramo



MAB26-152  
16.5 cm / 6 1/2"

MAB26-153  
24 cm / 9 1/2"

Mund-, Kiefer-, Gesichtschirurgie . Oral Maxillo-Facial Surgery . Cirugia oral y maxilofacial  
 Ramusklemmen  
 Ramus Clamps  
 Pinzas de rama  
 Clamps pour ramus  
 Pinze per ramo

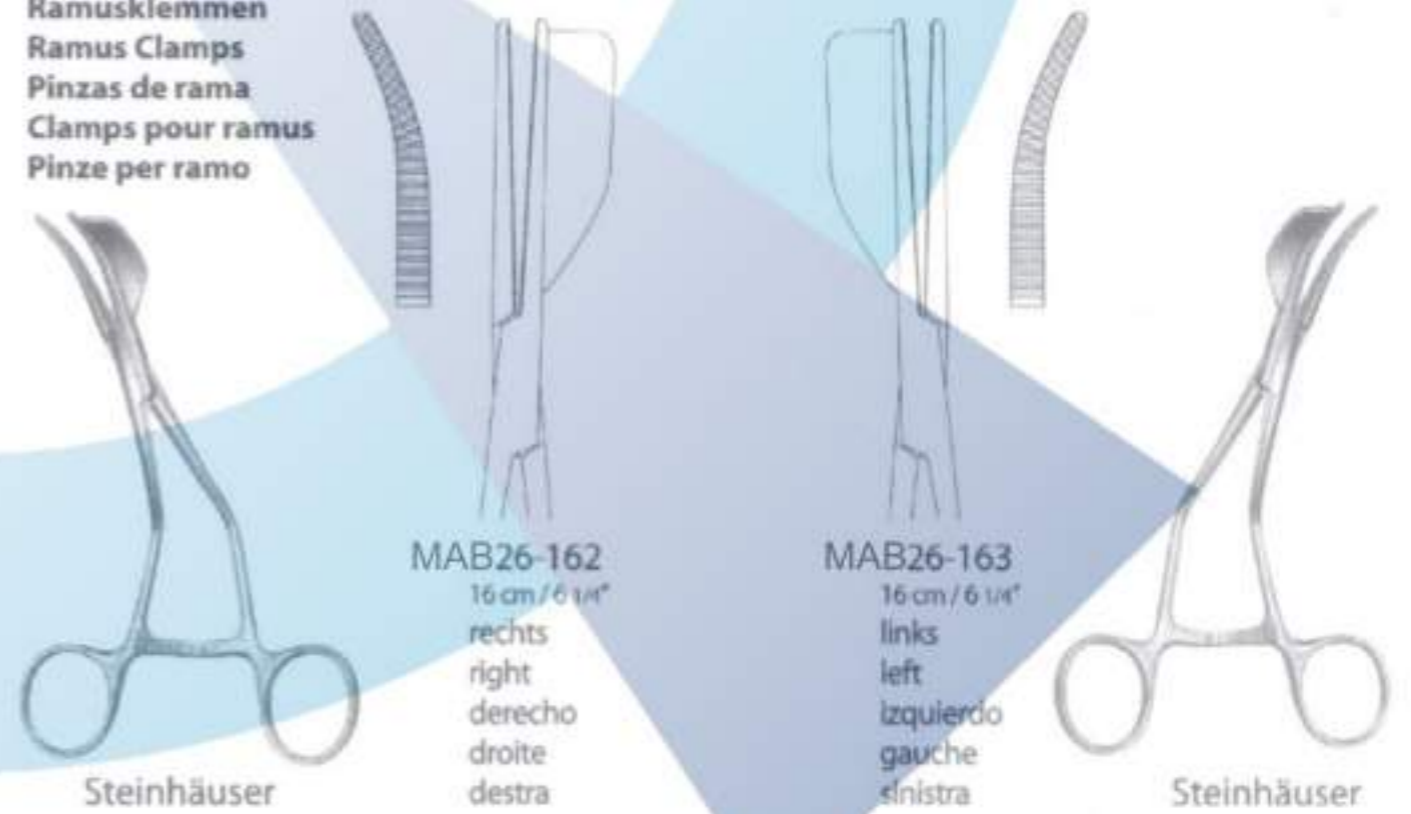

MAB26-162  
16 cm / 6 1/4"  
rechts  
right  
derecho  
droite  
destra

MAB26-163  
16 cm / 6 1/4"  
links  
left  
izquierdo  
gauche  
sinistra

Mund-, Kiefer-, Gesichtschirurgie . Oral Maxillo-Facial Surgery . Cirugia oral y maxilofacial  
 Palatumspreizer  
 Palatal Expander  
 Separador paladial  
 Ecarteur pour ostéotomie palatine  
 Separatore per palato



MAB26-159  
17 cm / 6 3/4"

Turvey

Mund-, Kiefer-, Gesichtschirurgie . Chirurgie buccale et maxillo-faciale . Chirurgia maxillo-facciale  
 Ramusosteotome, Meißel  
 Ramus Osteotomes, Chisels  
 Osteótomos de rama, Cinceles  
 Ostéotome pour ramus, Ciseaux-burins  
 Osteotomi per ramo, Scalpelli

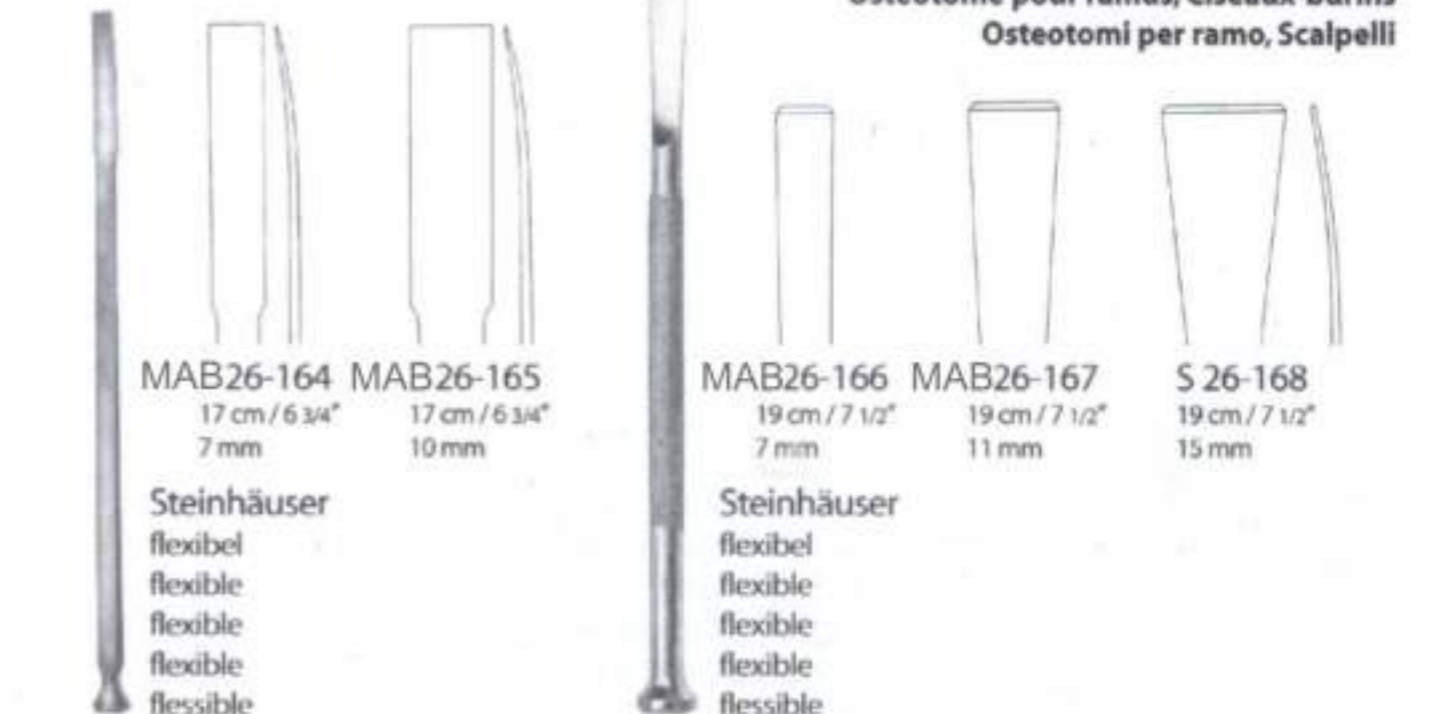

MAB26-164 MAB26-165  
17 cm / 6 3/4" 7 mm 17 cm / 6 3/4" 10 mm  
Steinhäuser  
flexibel  
flexible  
flexible  
flexible  
flexible

MAB26-166 MAB26-167 S 26-168  
19 cm / 7 1/2" 7 mm 19 cm / 7 1/2" 11 mm 19 cm / 7 1/2" 15 mm  
Steinhäuser  
flexibel  
flexible  
flexible  
flexible  
flexible

Mund-, Kiefer-, Gesichtschirurgie . Chirurgie buccale et maxillo-faciale . Chirurgia maxillo-facciale  
 Elevatorien, Unterkieferhaken  
 Elevators, Channel Retractors  
 Elevadores, Separador mandibular  
 Élévateurs, Crochet pour mandibule  
 Elevatori, Separatori per mandibula



MAB26-160  
18.5 cm / 7 1/4"

Steinhäuser

MAB26-161  
27 cm / 10 1/2"  
extra lang  
extra long  
muy largo  
très long  
molto lungo

Steinhäuser



Mund-, Kiefer-, Gesichtschirurgie . Oral Maxillo-Facial Surgery . Cirugía oral y maxilofacial

Raspatorien  
Periosteal Elevators  
Legras  
Rugine-raspatoires  
Elevatori per periosteo



MAB 26-169  
18 cm / 7"

Steinhäuser  
Repositionsinstrument  
Reposition Instrument  
Instrumento de reposición  
Instrument de reposition  
Strumento per riduzione



MAB26-170 16 cm / 6 1/4"  
6 x 12 mm

MAB26-171 16.5 cm / 6 1/2"  
6 x 19 mm

MAB26-172 17 cm / 6 3/4"  
6 x 26 mm

Steinhäuser

Mund-, Kiefer-, Gesichtschirurgie . Chirurgie buccale et maxillo-faciale . Chirurgia maxillo-facciale



Steinhäuser



MAB26-173 23 cm / 9"  
20 x 50 mm  
rechts  
right  
derecho  
droite  
destra

MAB26-174 23 cm / 9"  
20 x 50 mm  
links  
left  
izquierdo  
gauche  
sinistra

Zygoma-Wundhaken  
Zygomatic Retractor  
Separador cigomático  
Ecarteur cygomatique  
Divaricatore per zigomo

Mund-, Kiefer-, Gesichtschirurgie . Oral Maxillo-Facial Surgery . Cirugía oral y maxilofacial

Raspatorien, Osteotome  
Raspatories, Osteotomes  
Legras, Osteótomos  
Rugine-raspatoires, Ostéotomes  
Elevatori per periosteo, Osteotomi



MAB26-175  
16.5 cm / 6 1/2"  
3 mm

Steinhäuser



MAB26-176  
18 cm / 7"  
5 mm

Steinhäuser



MAB26-177  
18 cm / 7"  
8 mm

Steinhäuser



MAB26-178  
23 cm / 9"  
6 mm

Wolford



MAB26-179  
23 cm / 9"  
8 mm

Mund-, Kiefer-, Gesichtschirurgie . Chirurgie buccale et maxillo-faciale . Chirurgia maxillo-facciale

Gaumenspalten-Instrumente  
Cleft Palate Instruments  
Instrumentos paladares  
Instruments pour palais  
Strumenti per palato



Salyer  
MAB26-180  
18.5 cm / 7 1/4"  
Gaumenspalten-Häkchen  
Cleft Palate Hooklets  
Ganchito para el paladar  
Crochet pour palais  
Uncino per palato  
Kurzes Blatt  
short blade  
hoja corta  
lame courte  
lama corta

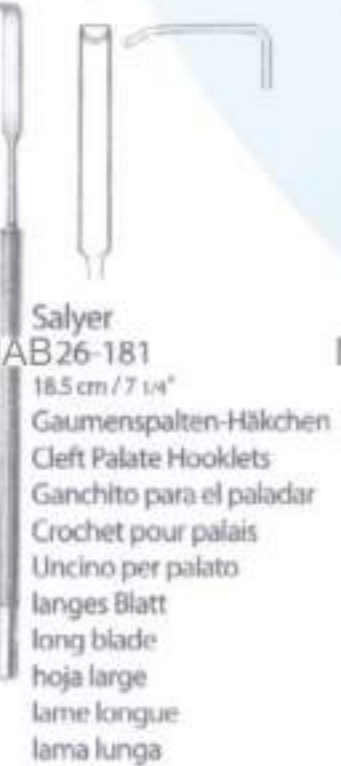

Salyer  
MAB26-181  
18.5 cm / 7 1/4"  
Gaumenspalten-Häkchen  
Cleft Palate Hooklets  
Ganchito para el paladar  
Crochet pour palais  
Uncino per palato  
langes Blatt  
long blade  
hoja large  
lame longue  
lama lunga



Salyer  
MAB26-182  
18 cm / 7"  
Gaumenspalten-Dissektor  
Cleft Palate Dissector  
Disecador pra el paladar  
Dissecteur pour palais  
Disettore per palato  
nasal  
nasal  
nasal  
nasale  
nasale



Salyer  
MAB26-183  
18 cm / 7"  
Gaumenspalten-Dissektor  
Cleft Palate Dissector  
Disecador pra el paladar  
Dissecteur pour palais  
Disettore per palato  
nasal  
nasal  
nasal  
nasale  
nasale



Salyer  
MAB26-184  
18 cm / 7"  
Gaumenspalten-Elevatorium  
Cleft Palate Instruments  
Instrumentos paladares  
Instruments pour palais  
Strumenti per palato



Salyer  
MAB26-185  
18 cm / 7"  
Gaumenspalten-Elevatorium  
Cleft Palate Elevator  
Elevador para el paladar  
Elevateur pour palais  
Elevatore per palato



Salyer  
MAB26-186  
18 cm / 7"  
Gaumenspalten-Elevatorium  
Cleft Palate Elevator  
Elevador para el paladar  
Elevateur pour palais  
Elevatore per palato



JABOMA  
MAB26-187  
17 cm / 6 3/4"  
Gaumenspalten-Raspatorium  
Cleft Palate Elevator  
Elevador para el paladar  
Elevateur pour palais  
Elevatore per palato

MAB 27

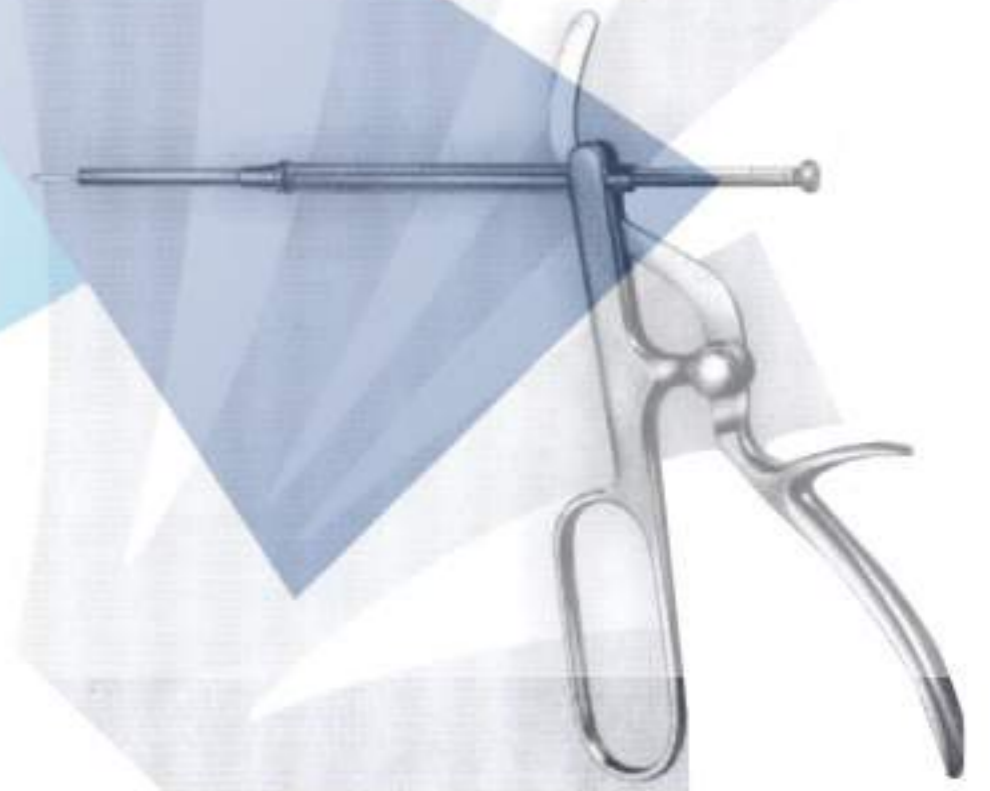

Kranio-Maxillofaziale Chirurgie  
Craino-Maxillo-Facial Surgery  
Cirugia cranei-maxilofacial  
Chirurgie du crane et maxillo-faciale  
Chirurgiea carnio-maxillo-facciale



**Tonsillektomie . Tonsillectomy . Tonsilectomia**  
**Gaumennadeln**  
**Cleft Palate Needles**  
**Agujas para sutura del paladar**  
**Aiguilles pour suturer du palais**  
**Aghe per sutura del palato**

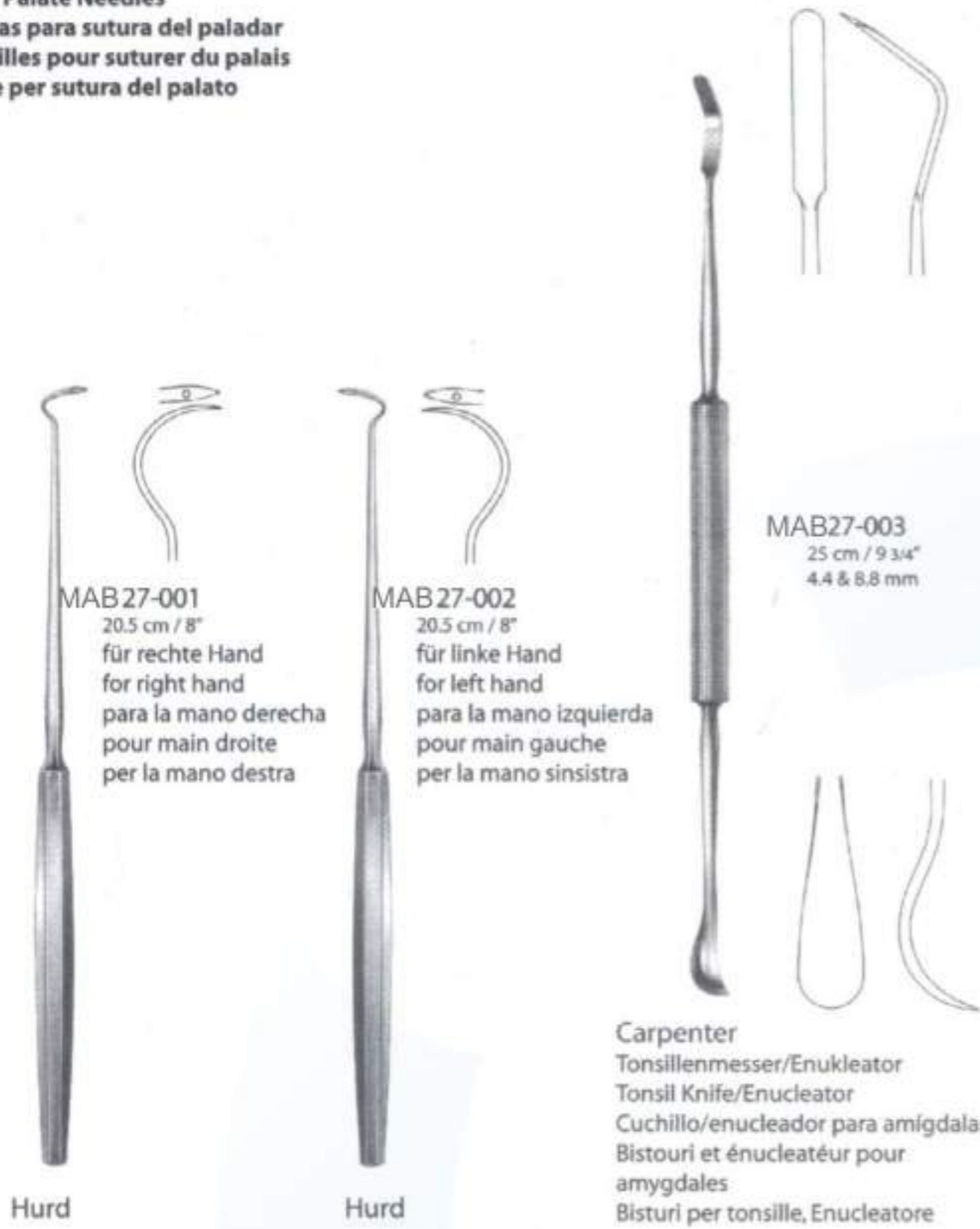

**Tonsillektomie . Tonsillectomie . Tonsilectomia**  
**Tonsillenelevator/Retraktor, Tonsillenelevatorien**  
**Tonsil Dissector/Retractor, Tonsil Elevators**  
**Dissector/separador para amígdalas, Elevadores para amígdalas**  
**Dissecteur/Rétracteur pour amygdales, Elévateurs pour amygdales**  
**Dissettori/Retrattori per tonsille, Elevattori per tonsille**

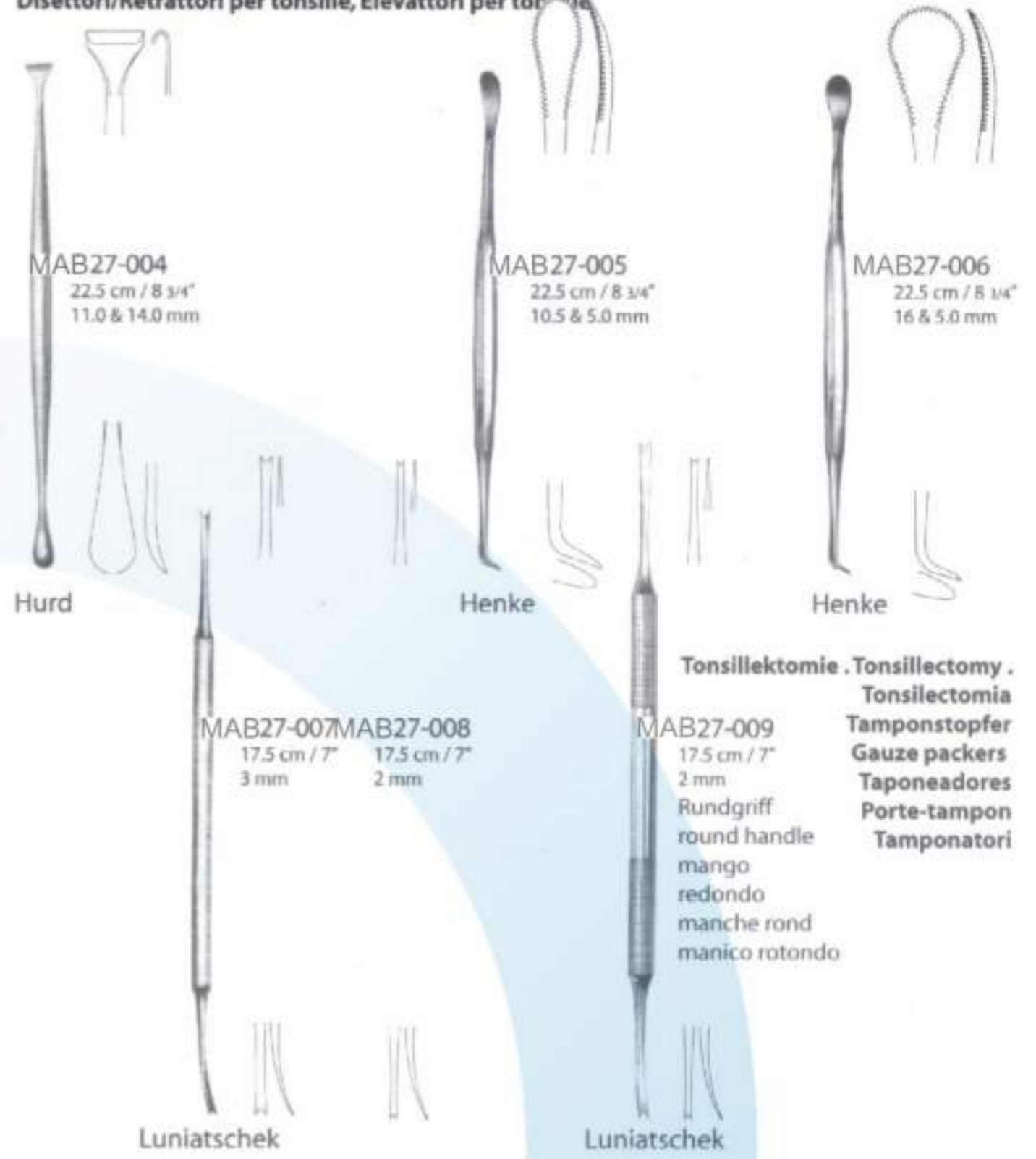

**Tonsillektomie . Tonsillectomie . Tonsilectomia**  
**Tonsillenfasszangen, Tonsillenklemmen**  
**Tonsil Grasping Forceps, Tonsil Forceps**  
**Pinzas para amígdalas**  
**Pinces pour amygdales**  
**Pinze per tonsille**

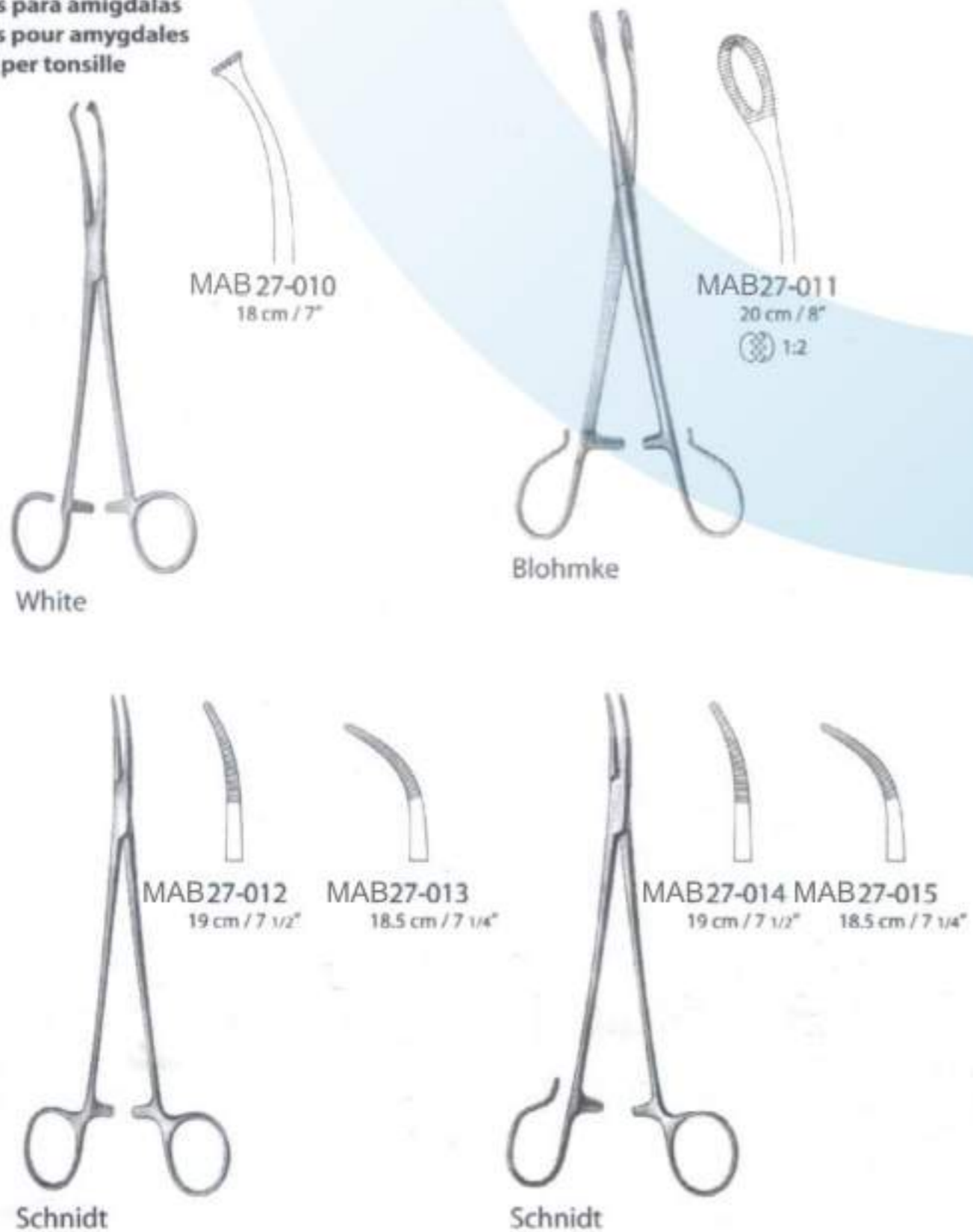

**Tonsillektomie . Tonsillectomy . Tonsilectomia**  
**Tonsillenschnürer**  
**Tonsil Snare**  
**Cierra-nudos para amígdalas**  
**Serre-noeuds pour amygdales**  
**Serranodi per tonsille**

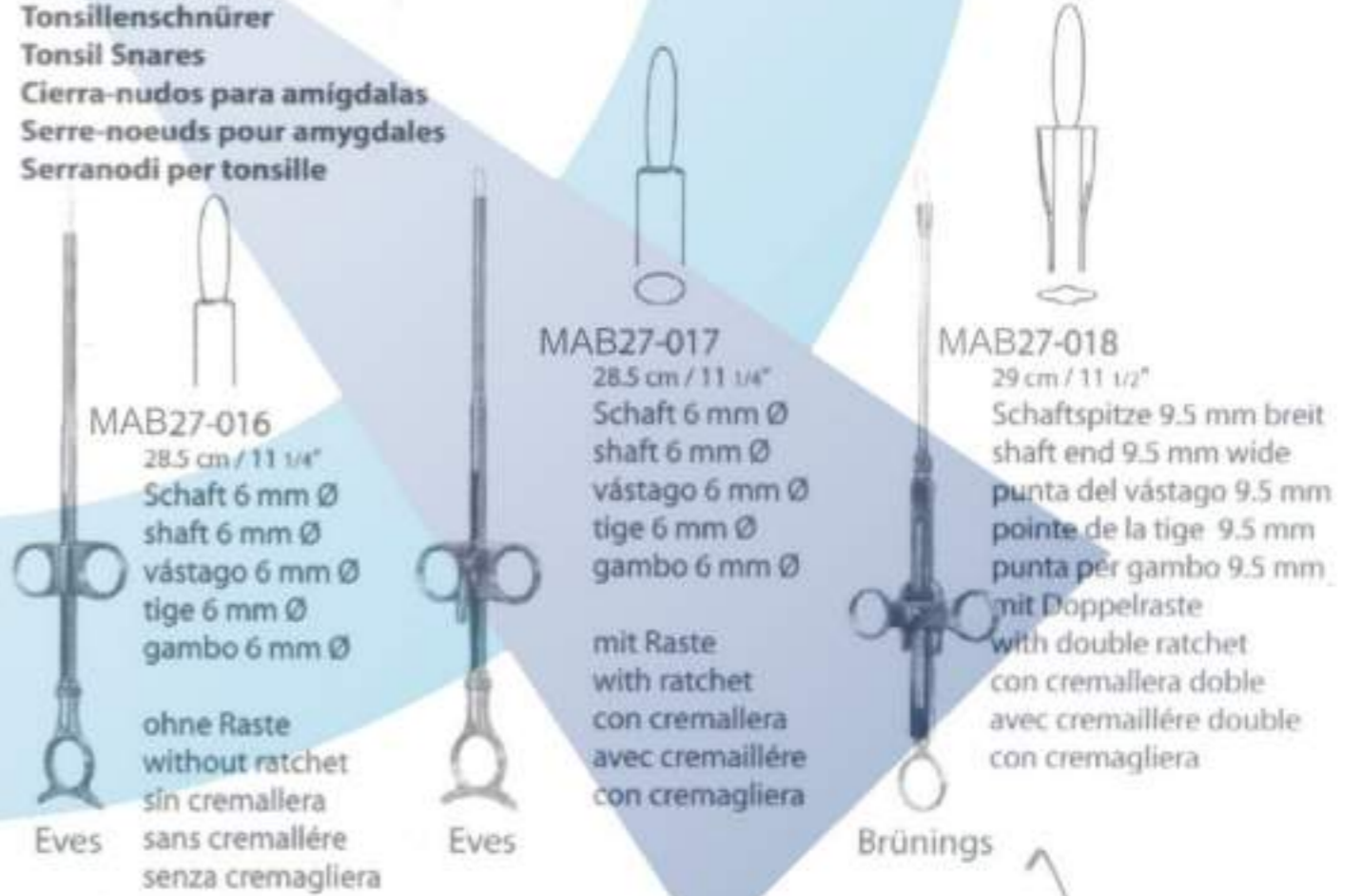



Tonsillektomie . Tonsillectomie . Tonsilectomía  
Tonsillenzangen  
Ponsil Punches  
Pinzas para amígdalas  
Pinces pour amygdales  
Pinze per tonsille



Laryngo-Bronchoskopie . Laryngo-Bronchoscopy . Laringo-Bronchoscopia  
Broncho-Oesophagoskopiezangen  
Broncho-Esophagocopy Forceps  
Pinzas para Broncho-Esofagoscopia  
Pinces pour Broncho-Esofagoscopie  
Pinze per Broncho-Esofagoscopia

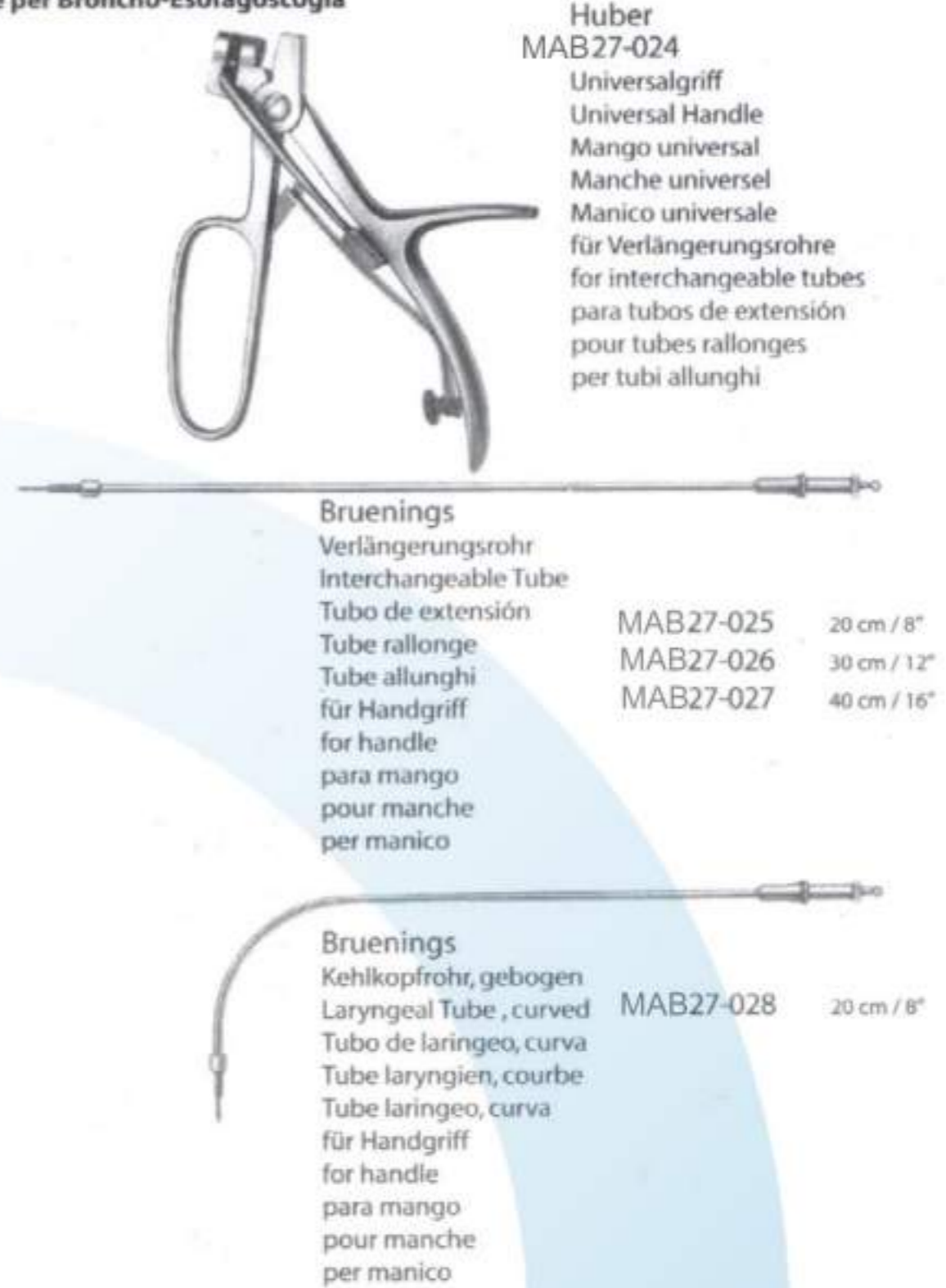

Laryngo-Bronchoskopie . Laryngo-Bronchoscopy . Laringo-Bronchoscopia  
Auswechselbare Zangenaufsätze  
Exchangeable Tips  
Pinzas intercambiables  
Embouts interchangeables  
Pinze intercambiabili

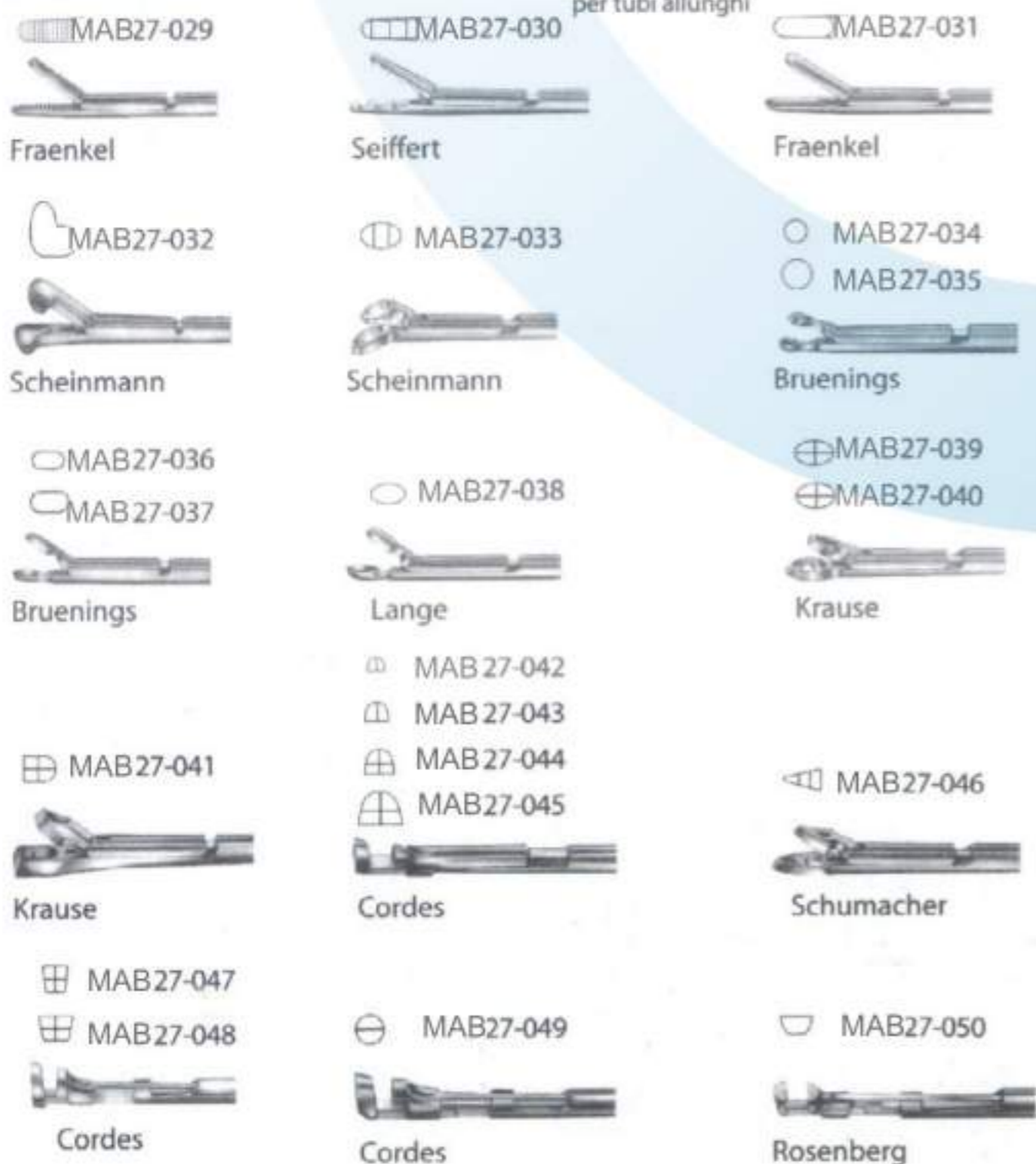

Laryngo-Bronchoskopie . Laryngo-Bronchoscopy . Laringo-Bronchoscopia  
Kehlkopfspiegel, Kehlkopfspiegel-Griffe  
Laryngeal Mirrors, Laryngeal Mirror Handles  
Espejos laringeos, Mangos para espejos laringeos  
Miroirs laryngiens, Manche pour miroirs laryngiens  
Specchi laringei, Manico per specchi laringei

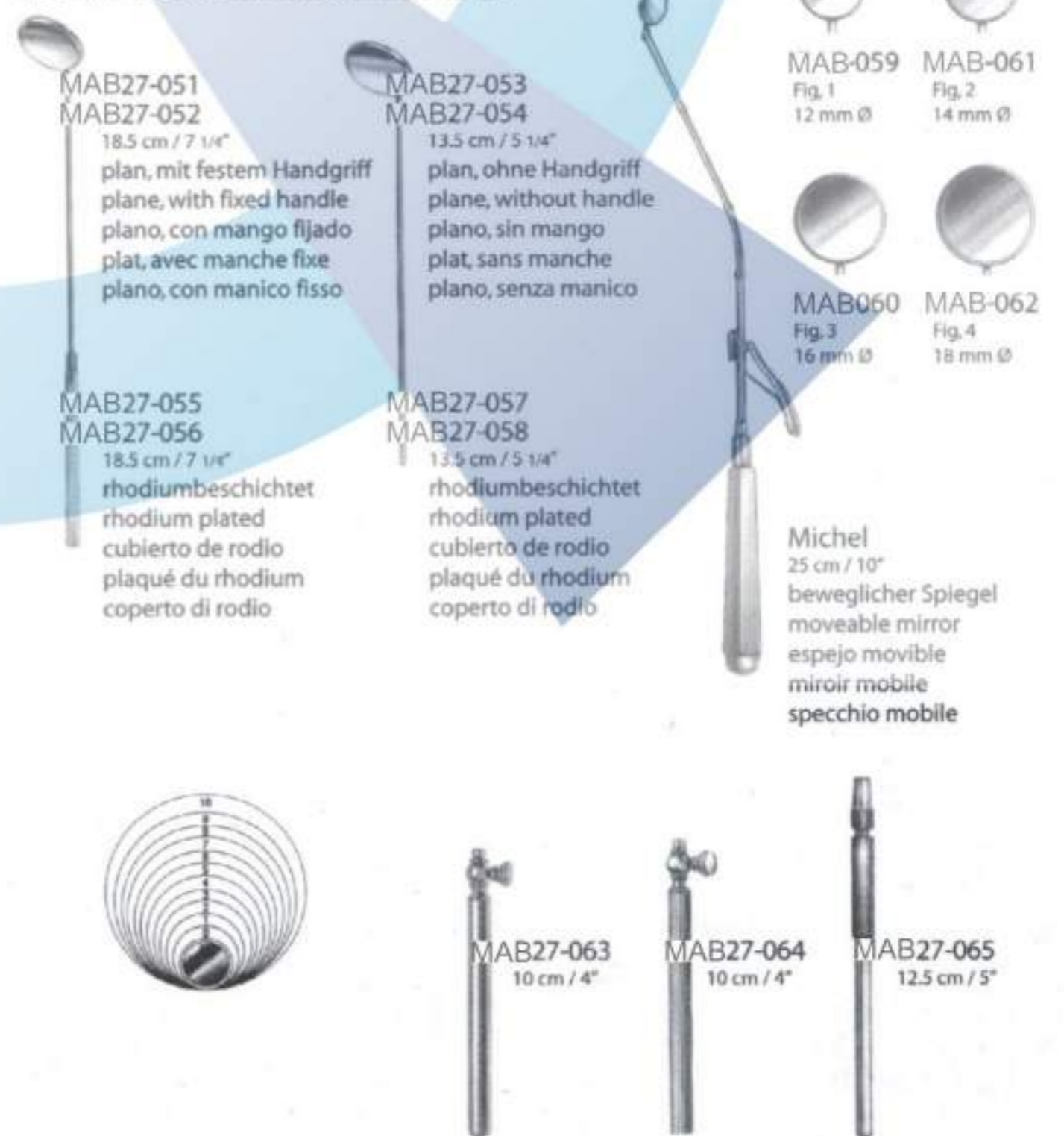



## MAB 28

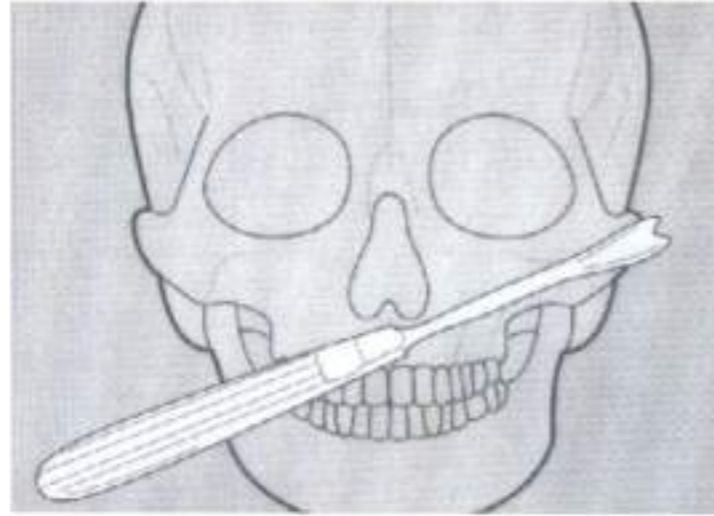

Kranio-Maxillofaziale Chirurgie  
 Cranio-Maxillo-Facial Surgery  
 Cirurgia craneo-maxilofacial  
 Chirurgie du crane et maxillo-faciale  
 Chirurgia cranio-maxillo-facciale

Kranio-Maxillofaziale Chirurgie . Cranio-Maxillo-Facial Surgery . Cirurgia craneo-maxilofacial  
 Weichteilhaken  
 Soft Tissue Retractors  
 Separadores para partes blandes  
 Ecarteurs pour parties molles  
 Divaricatori per tessuti molli



MAB28-001  
5 x 16 mm

MAB28-002  
7 x 25 mm

MAB28-003  
10 x 35 mm

MAB28-004  
10 x 42 mm

MAB28-005  
12 x 55 mm

MAB28-006  
14 x 70 mm

MAB28-007  
16 x 80 mm



Obwegeser  
24 cm / 9 1/2"  
aufwärts gebogen  
bent upwards  
angulado hacia arriba  
coudé en haut  
angolato in alto

Kranio-Maxillofaziale Chirurgie . Chirurgie du crane et maxillo-faciale .  
 Chirurgia cranio-maxillo-facciale  
 Weichteilhaken  
 Soft Tissue Retractors  
 Separadores para partes blandes  
 Ecarteurs pour parties molles  
 Divaricatori per tessuti molli

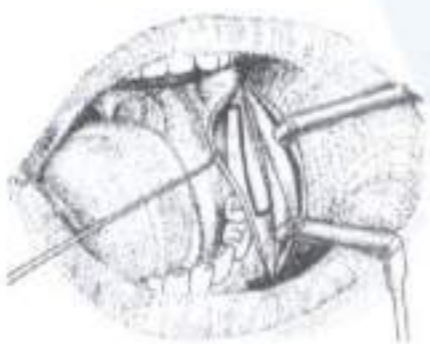

MAB28-008  
5 x 16 mm

MAB28-009  
7 x 25 mm

MAB28-010  
10 x 35 mm

MAB28-011  
10 x 42 mm

MAB28-012  
12 x 55 mm

MAB28-013  
14 x 70 mm

MAB28-014  
16 x 80 mm



Obwegeser  
24 cm / 9 1/2"  
aufwärts gebogen  
bent downwards  
angulado hacia abajo  
coudé en bas  
angolato in basso

Kranio-Maxillofaziale Chirurgie . Cranio-Maxillo-Facial Surgery . Cirurgia craneo-maxilofacial  
 Unterkieferhaken  
 Mandibular Retractors  
 Separadores mandibulares  
 Ecarteurs mandibulaires  
 Divaricatori mandibulari



MAB28-015  
9/12 x 30 mm

MAB28-016  
9/12 x 45 mm

MAB28-017  
9/12 x 60 mm

Obwegeser  
21 cm / 8 1/4"

Kranio-Maxillofaziale Chirurgie . Chirurgie du crane et maxillo-faciale .  
 Chirurgia cranio-maxillo-facciale  
 Ramushaken  
 Ramus Retractors  
 Separadores para el ramo  
 Ecarteurs pour ramus  
 Separatori per il ramo



MAB28-018  
11/15 x 70 mm

MAB28-019  
12/22 x 70 mm

Obwegeser  
24.5 cm / 9 3/4"



Kranio-Maxillofaziale Chirurgie . Cranio-Maxillo-Facial Surgery . Cirugia craneo-maxilofacial  
**Weisheitszahn-Haken**  
**Third Molar Retractor**  
**Separador para muela del juicio**  
**Ecarteur pour dent de sagesse**  
**Separatore per il dente del giudizio**



**Obwegeser**  
 24 cm / 9 1/2"  
 Weisheitszahn-Haken  
 Third Molar Retractor  
 Separador para muela juicio  
 Ecarteur pour dent de sagesse  
 Separatore per il dente del giudizio



Kranio-Maxillofaziale Chirurgie . Cranio-Maxillo-Facial Surgery . Cirugia craneo-maxilofacial  
**Ramusklappen**  
**Ramus Clamps**  
**Pinzas para el ramo**  
**Pinces pour ramus**  
**Pinze per il ramo**

MAB28-022  
**Obwegeser**  
 15 cm / 6"  
 Kleines Modell, rechts  
 small pattern, right  
 modelo pequeño, derecho  
 modèle petit, droit  
 modello piccolo, destro



MAB28-024  
**Obwegeser**  
 15 cm / 6"  
 Kleines Modell, links  
 small pattern, left  
 modelo pequeño, izquierdo  
 modèle petit, gauche  
 modello piccolo, sinistro



MAB28-023  
**Obwegeser**  
 20 cm / 8"  
 großes Modell, rechts  
 large pattern, right  
 modelo grande, derecho  
 modèle grand, droit  
 modello grande, destro



MAB28-025  
**Obwegeser**  
 20 cm / 8"  
 großes Modell, links  
 large pattern, left  
 modelo grande, izquierdo  
 modèle grand, gauche  
 modello grande, sinistro

Kranio-Maxillofaziale Chirurgie . Chirurgie du crâne et maxillo-faciale .  
**Chirurgia cranio-maxillo-facciale**  
**Spina nasalis-Haken**  
**Nasal Spine Retractor**  
**Separador para espina nasal**  
**Ecarteur pour spina nasalis**  
**Separatore per spina nasale**

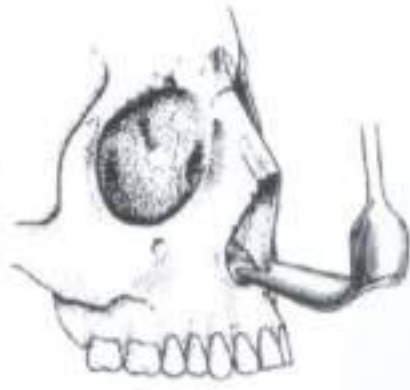

**Obwegeser**  
 24.5 cm / 9 3/4"  
 Spina nasalis-Haken  
 Nasal Spine Retractor  
 Separador para espina nasal  
 Ecarteur pour spina nasalis  
 Separatore per spina nasale

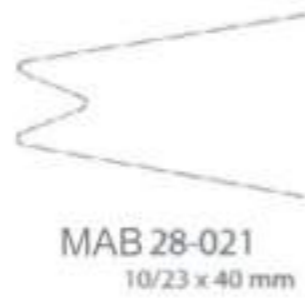

Kranio-Maxillofaziale Chirurgie . Chirurgie du crâne et maxillo-faciale .  
**Chirurgia cranio-maxillo-faccial**  
**Progenierinnen**  
**Channel Retractors**  
**Separadores mandibulares**  
**Ecarteurs mandibulaires**  
**Separatori mandibulari**

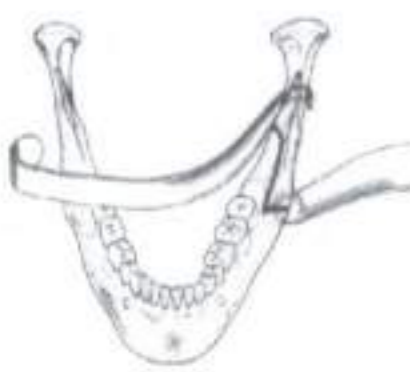

**Obwegeser**  
 16.5 cm / 6 1/2"



Kranio-Maxillofaziale Chirurgie . Chirurgie du crâne et maxillo-faciale .  
**Chirurgia cranio-maxillo-faccial**  
**Raspatorien**  
**Periosteal Elevators**  
**Legras**  
**rugine-raspatoires**  
**Elevatori periostali**



**Obwegeser**  
 18 cm / 7"  
 winkelig angeschliffen  
 angled cutting  
 biselado angular  
 tranchant angulé  
 affilatura angolata



Kranio-Maxillofaziale Chirurgie . Cranio-Maxillo-Facial Surgery . Cirugia craneo-maxilofacial  
**Kinnhalter**  
**Chin Holder**  
**Separador para mentón**  
**Ecarteur mandibulaires**  
**Divaricatore mandibulari**



**Obwegeser**  
 16 cm / 6 1/4"  
 Kinnhalter  
 Chin Holder  
 Separador para mentón  
 Ecarteur pour menton  
 Divaricatore per mento



Kranio-Maxillofaziale Chirurgie . Cranio-Maxillo-Facial Surgery . Cirugia craneo-maxilofacial



**Obwegeser**  
 18 cm / 7"  
 flach angeschliffen  
 flat cutting  
 biselado plano  
 tranchant plat  
 affilatura plana





Kranio-Maxillofaziale Chirurgie . Chirurgie du crâne et maxillo-faciale .  
Chirurgia cranio-maxillo-facciale  
Unterkiefer-Raspatorien  
Mandibular Inferior Border Raspatories  
Legras para el borde mandibular  
Rugine-raspatoire pour le bord mandibulaire  
Staccaperiostio per bordo mandibulare

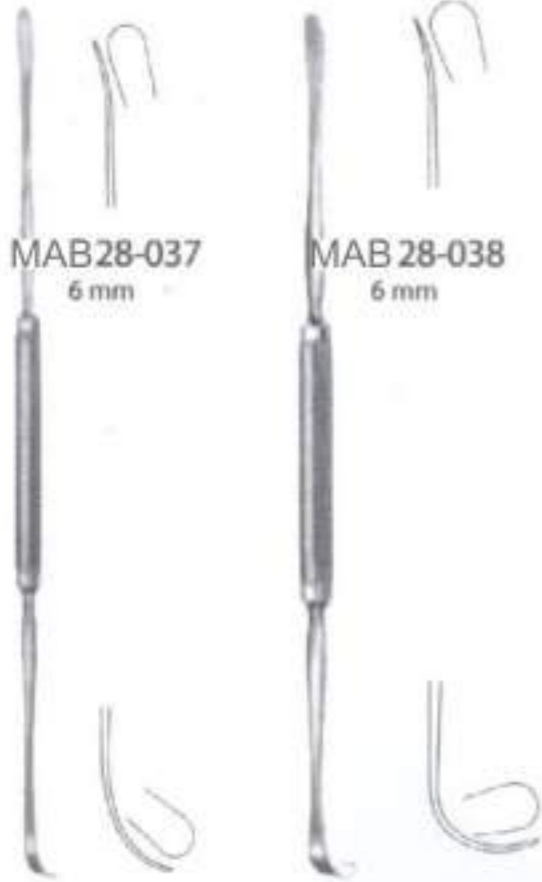
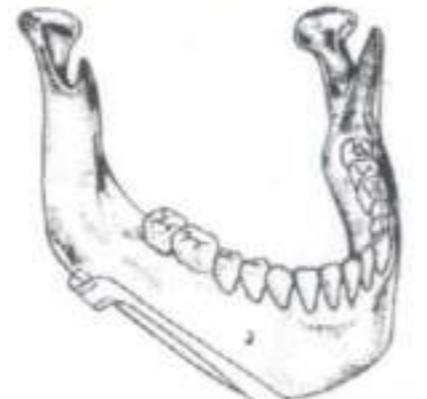

MAB28-037  
6 mm

MAB28-038  
6 mm

Obwegeser  
21 cm / 8 1/4"  
Elevatorium  
Elevator  
Elevador  
Élévateur  
Elevatore

Obwegeser  
21 cm / 8 1/4"  
Raspatorium  
Raspatory  
Legra  
Rugine-raspatoire  
Elevatore periostale



MAB28-039  
10 mm

MAB28-040  
10 mm

Obwegeser  
18 cm / 7"  
nach links gewinkelt  
angled to left  
angulado hacia la izquierda  
coudé à gauche  
angolato a sinistra

Obwegeser  
18 cm / 7"  
nach rechts gewinkelt  
angled to right  
angulado hacia la derecha  
coudé à droite  
angolato a destra

Kranio-Maxillofaziale Chirurgie . Cranio-Maxillo-Facial Surgery . Cirugia craneo-maxilofacial  
Schwalbenschwanz-Raspatorien  
Swallowtail Raspatories  
Legras en forma de cola de milano  
Rugine-raspatoire sous forme de queue d'aronde  
Staccaperiostio a coda di rondine

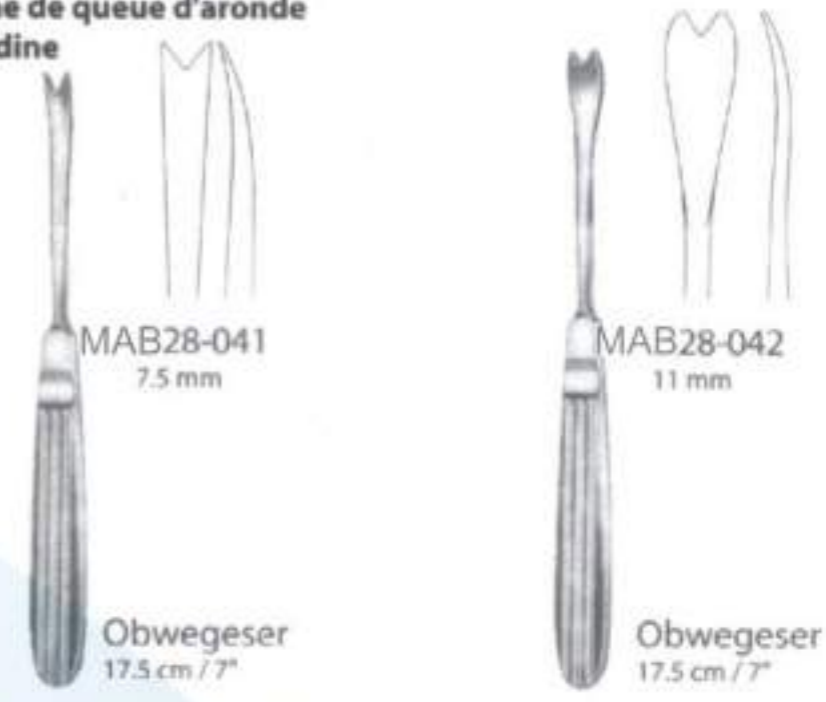

MAB28-041  
7.5 mm

MAB28-042  
11 mm

Obwegeser  
17.5 cm / 7"

Obwegeser  
17.5 cm / 7"

Kranio-Maxillofaziale Chirurgie . Chirurgie du crâne et maxillo-faciale .  
Chirurgia cranio-maxillo-facciale  
Ramusraspatorien  
Ramus Periosteal Elevators  
Legras para el ramo  
Rugine-raspatoire pour ramus  
Elevatori periostali per ramo

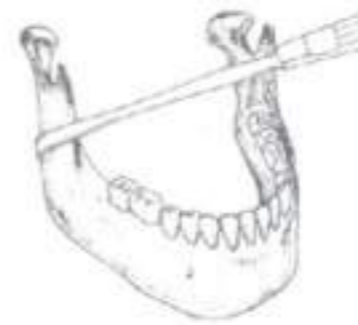

MAB28-043  
5 mm

MAB28-044  
7 mm

MAB28-046  
9 mm

Obwegeser  
20.5 cm / 8"

Kranio-Maxillofaziale Chirurgie . Cranio-Maxillo-Facial Surgery . Cirugia craneo-maxilofacial  
Septumosteotome  
Septonasal Osteotomes  
Osteótomos para el tabique nasal  
Ostéotomes pour cloison nasale  
Osteotomi per setto nasale

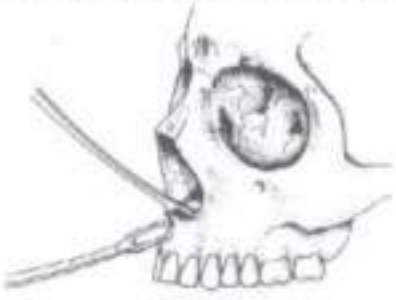

MAB28-047  
4 mm

MAB28-048  
6 mm

MAB28-049  
8 mm

Obwegeser  
18.5 cm / 7 1/4"  
graduirt  
graduated  
graduado  
gradué  
graduato

Kranio-Maxillofaziale Chirurgie . Cranio-Maxillo-Facial Surgery . Cirugia craneo-maxilofacial  
Blattosteotome  
Blade Osteotomes  
Osteótomos de hoja  
Ostéotome en lame  
Osteotomi

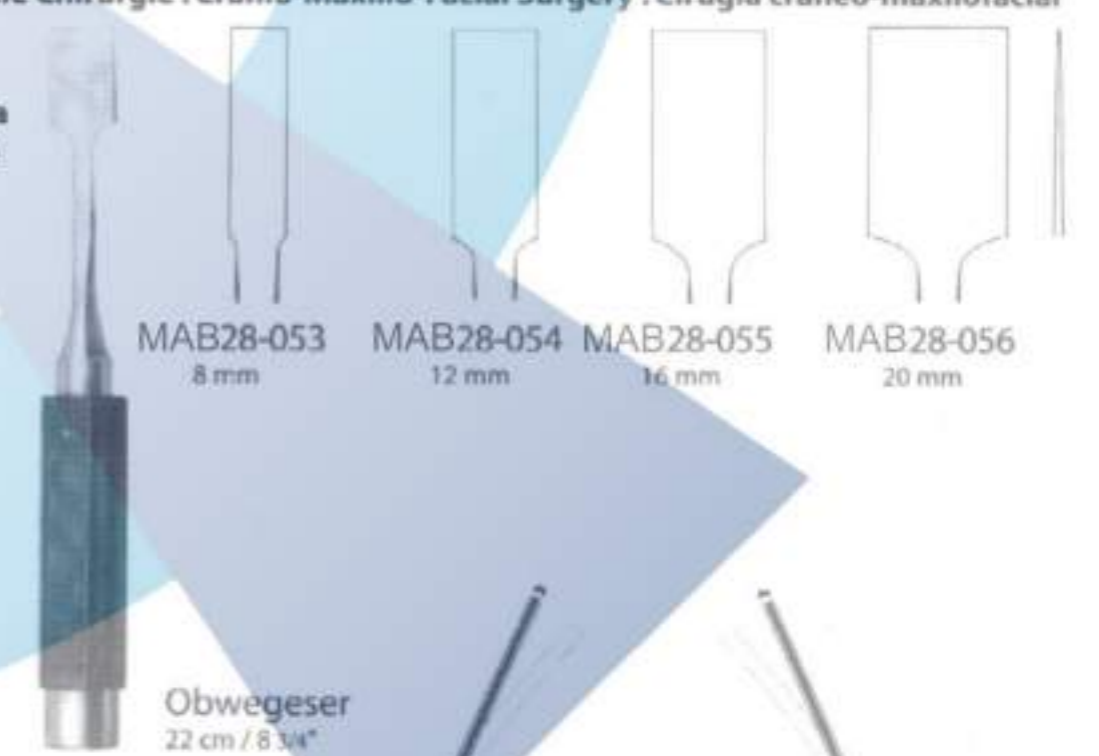

MAB28-053  
8 mm

MAB28-054  
12 mm

MAB28-055  
16 mm

MAB28-056  
20 mm

Obwegeser  
22 cm / 8 3/4"

Kranio-Maxillofaziale Chirurgie . Chirurgie du crâne et maxillo-faciale .  
Chirurgia cranio-maxillo-facciale  
Kellosteotome  
Wedge Osteotomes  
Osteótomos de cuña  
Ostéotome cunéiforme  
Osteotomi a forma di cuneo



MAB28-050  
8 mm

MAB28-051  
12 mm

MAB28-052  
16 mm

Obwegeser  
22 cm / 8 3/4"

Kranio-Maxillofaziale Chirurgie .  
Chirurgie du crâne et maxillo-faciale .  
Chirurgia cranio-maxillo-facciale  
Fragment-Adaptierungsklemmen  
Fragment Adapting Forceps  
Pinzas adaptadoras para fragmentos  
Clamps pour adaptation de fragments osseux  
Pinze per avvicinare frammenti

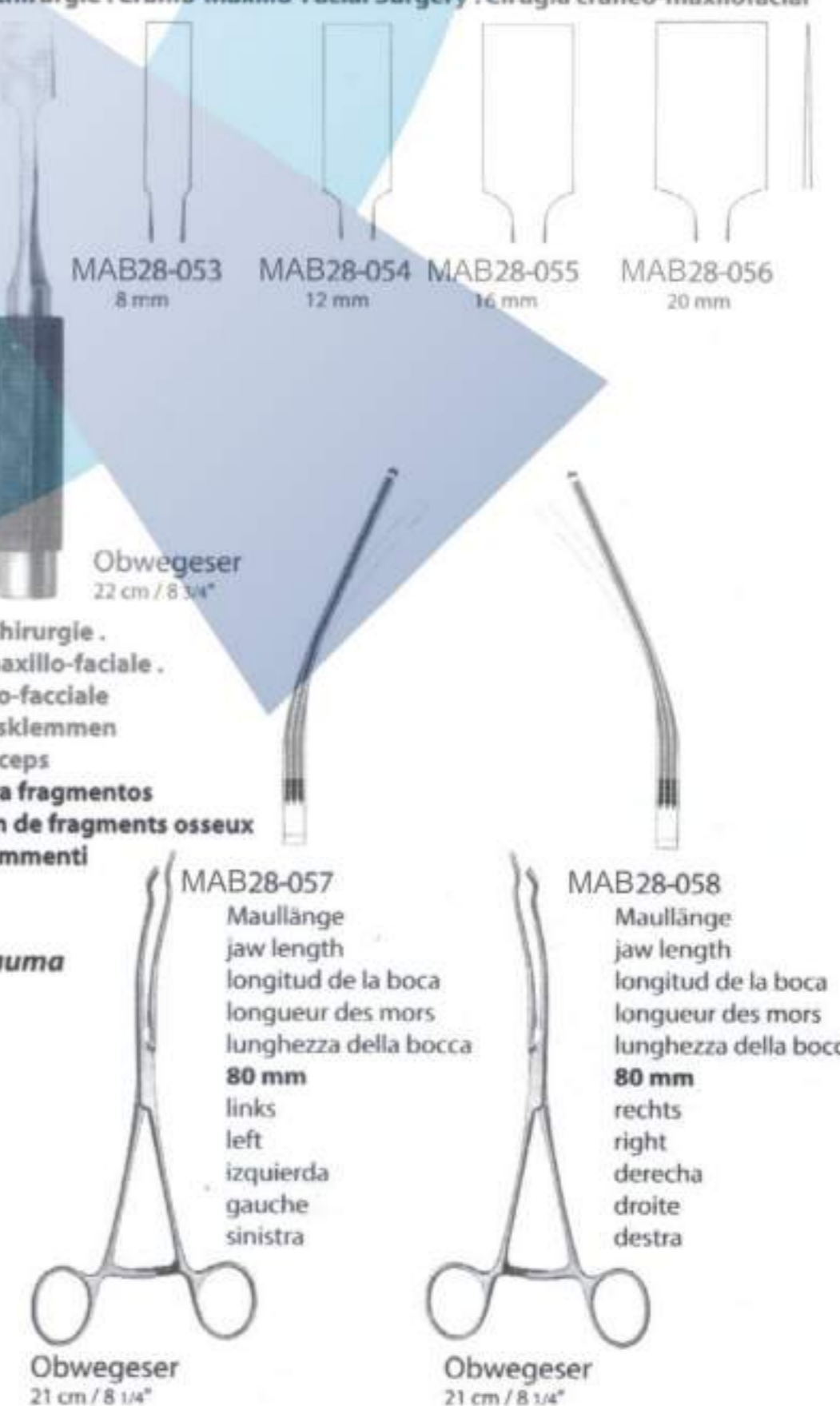

MAB28-057  
Maußlänge  
jaw length  
longitud de la boca  
longueur des mors  
lunghezza della bocca  
80 mm  
links  
left  
izquierda  
gauche  
sinistra

MAB28-058  
Maußlänge  
jaw length  
longitud de la boca  
longueur des mors  
lunghezza della bocca  
80 mm  
rechts  
right  
derecha  
droite  
destra

Atrauma

Obwegeser  
21 cm / 8 1/4"

Obwegeser  
21 cm / 8 1/4"



Kranio-Maxillofaziale Chirurgie . Cranio-Maxillo-Facial Surgery . Cirugia craneo-maxilofacial  
 Tube maxillae-Osteotome  
 Osteotomes for Maxillary Tuber  
 Osteótomos para tubérculo maxilar  
 Ostéotome pour tuber-maxillae  
 Osteotomi per tuberosità mascellari

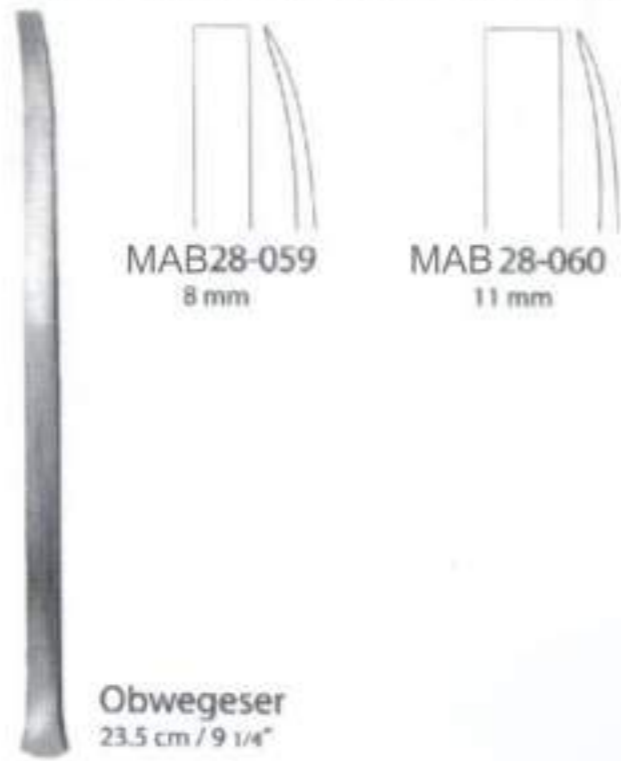
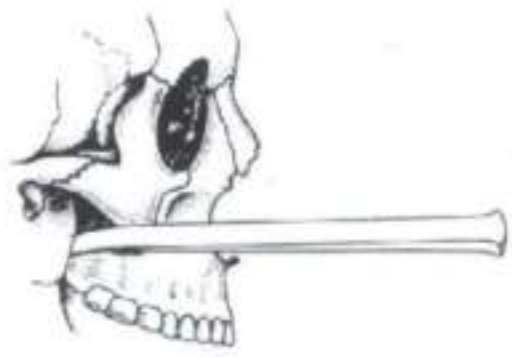

Kranio-Maxillofaziale Chirurgie . Cranio-Maxillo-Facial Surgery . Cirugia craneo-maxilofacial  
 Alveolarfortsatz-Osteotome  
 Osteotomes for Alveolar Process  
 Osteótomos para el proceso alveolar  
 Ostéotome pour bord alvéolaire  
 Osteotomi per processo alveolare

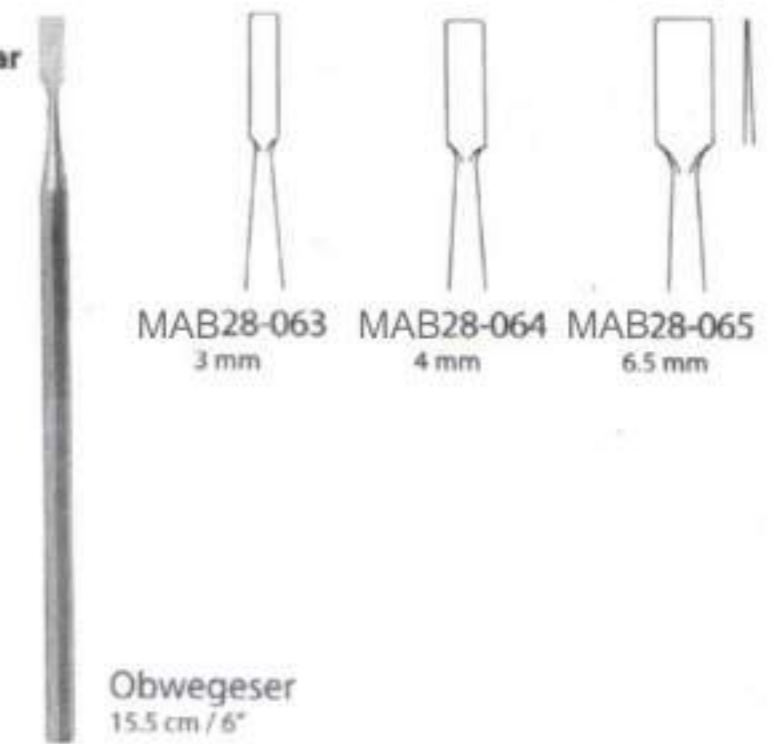

Kranio-Maxillofaziale Chirurgie . Chirurgie du crâne et maxillo-faciale .  
 Chirurgia cranio-maxillo-facciale  
 Osteotome  
 Osteotomes  
 Osteótomos  
 Ostéotomes  
 Osteotomi



Kranio-Maxillofaziale Chirurgie . Chirurgie du crâne et maxillo-faciale .  
 Chirurgia cranio-maxillo-facciale  
 Maxilla-Mobilisator  
 Maxillary Mobilizer  
 Mobilizador maxilar  
 Mobilisateur pour maxillaire  
 Mobilizzatore per mascella

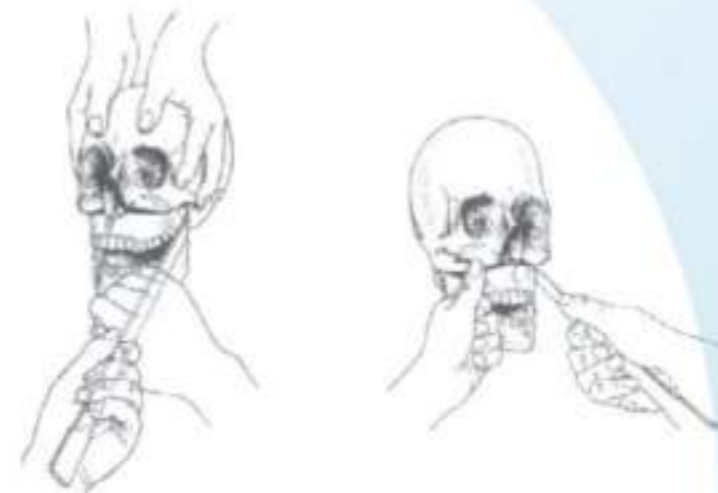

Kranio-Maxillofaziale Chirurgie . Cranio-Maxillo-Facial Surgery . Cirugia craneo-maxilofacial  
 Unterkieferahlen  
 Maxillary Awls  
 Leznas maxilares  
 Alènes maxillaires  
 Punteruolo per mandibola

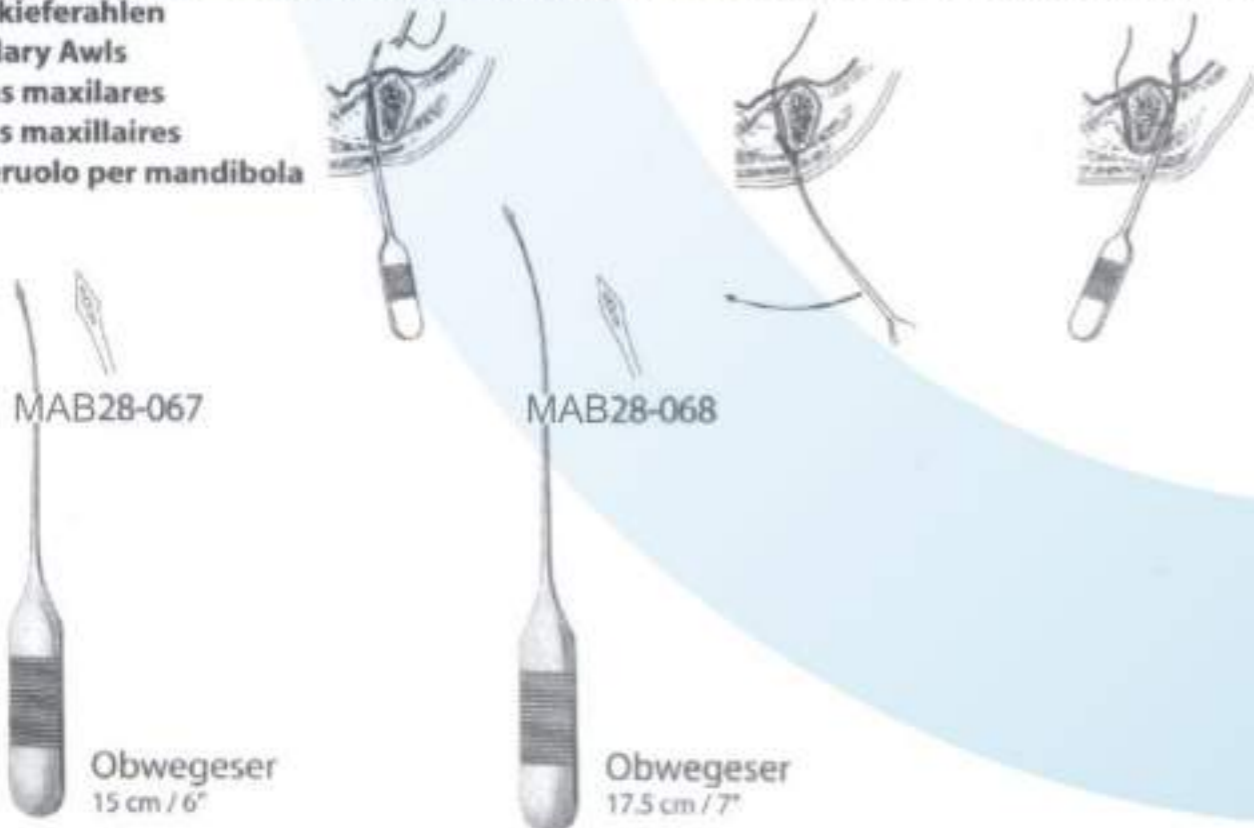

Kranio-Maxillofaziale Chirurgie . Cranio-Maxillo-Facial Surgery . Cirugia craneo-maxilofacial  
 Knochenformzangen  
 Bone Contouring Forceps  
 Pinzas para formar huesos  
 Pincers pour former os  
 Pinze per afferrare ossa

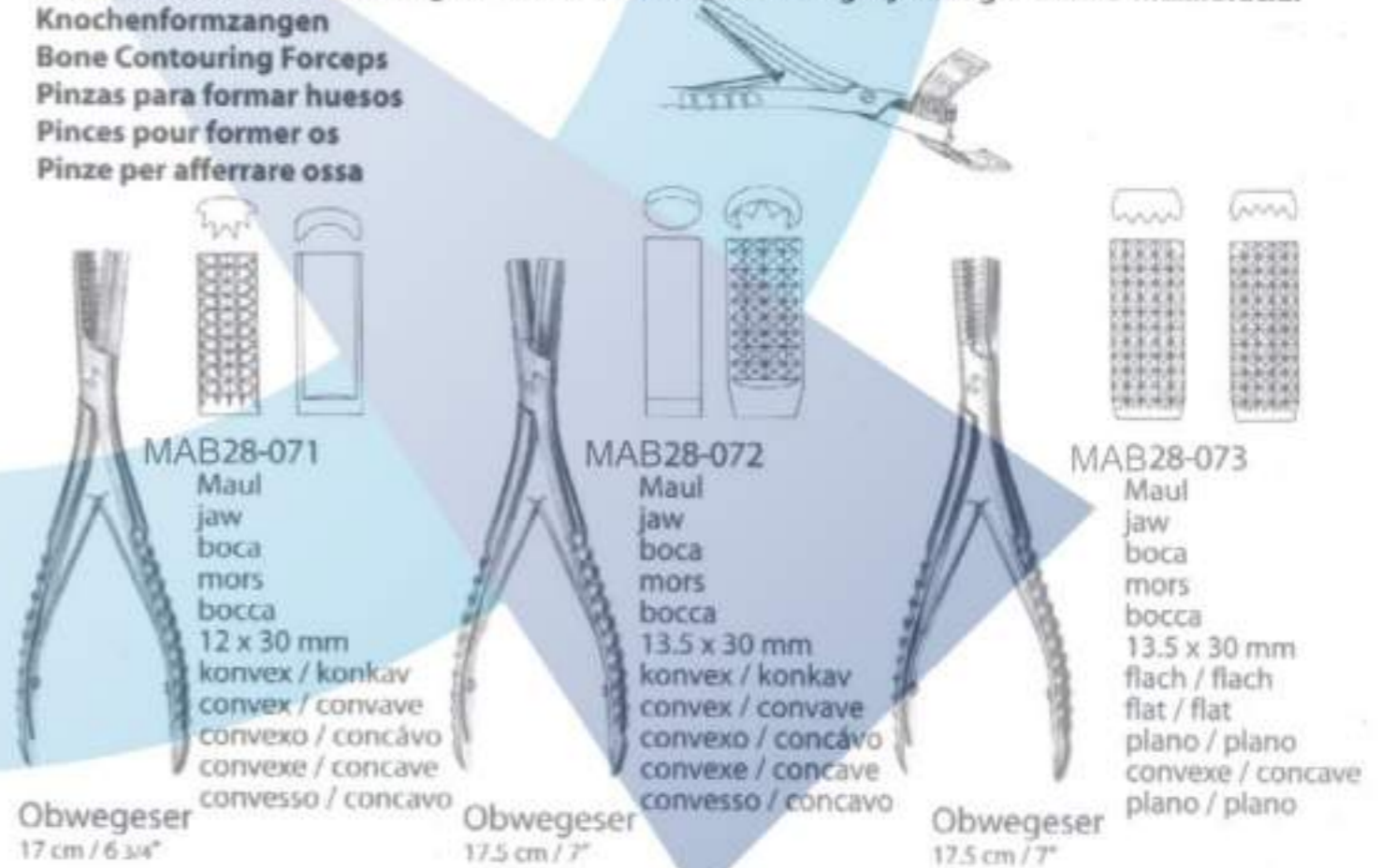

Kranio-Maxillofaziale Chirurgie . Chirurgie du crâne et maxillo-faciale .  
 Chirurgia cranio-maxillo-facciale  
 Jochbogenahle, Drahtschneidezange  
 Zygomatic Arch Awl, Wire Cutter  
 Lezna para el arco cigomático, Alicates para alambre  
 Alène pour l'arcade zygomatic, Pincers à couper le fill  
 Punteruolo per arco zigomatico, Tronchesino

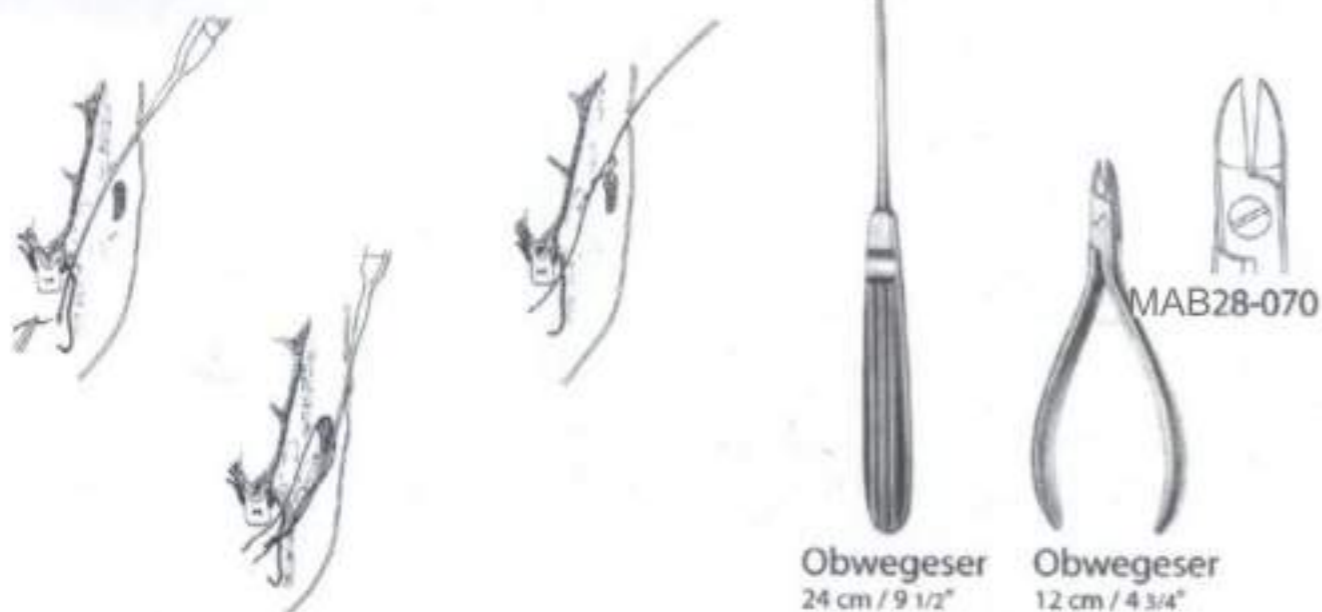

Kranio-Maxillofaziale Chirurgie . Chirurgie du crâne et maxillo-faciale .  
 Chirurgia cranio-maxillo-facciale  
 Hauthäkchen, Lopfhautklemme  
 Skin Hooklet, Scalp Clamp  
 Ganchito para piel, Pinza para cabelludo  
 Crochet pour peau, Pinza pour le cuir chevelu  
 Guancio per cute, Pinza per cuoio capelluto





Kranio-Maxillofaziale Chirurgie . Cranio-Maxillo-Facial Surgery . Cirugia craneo-maxilofacial  
 scharfe Küretten, Kürettenschärfer  
 Bone Curettes, Curette sharpener  
 Curettas cortantes, Afilador para curetas  
 Curettes coupantes, Aiguiseur à curettes  
 Curette teglienti, Affilatore per curette

Kranio-Maxillofaziale Chirurgie . Cranio-Maxillo-Facial Surgery . Cirugia craneo-maxilofacial  
 Nasenspekula  
 Nasal specula  
 Espéculos nasales  
 Spéculums nasaux  
 Specoli nasali

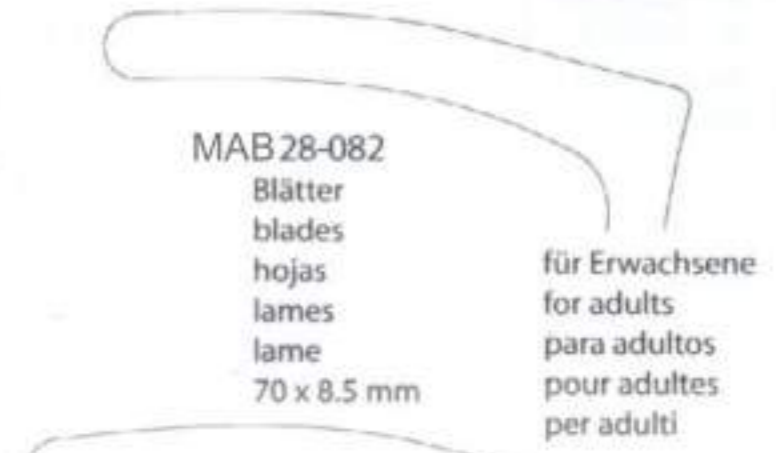

Kranio-Maxillofaziale Chirurgie . Chirurgie du crâne et maxillo-faciale .  
 Chirurgia cranio-maxillo-facciale  
 Nasenspekula  
 Nasal specula  
 Espéculos nasales  
 Spéculums nasaux  
 Specoli nasali

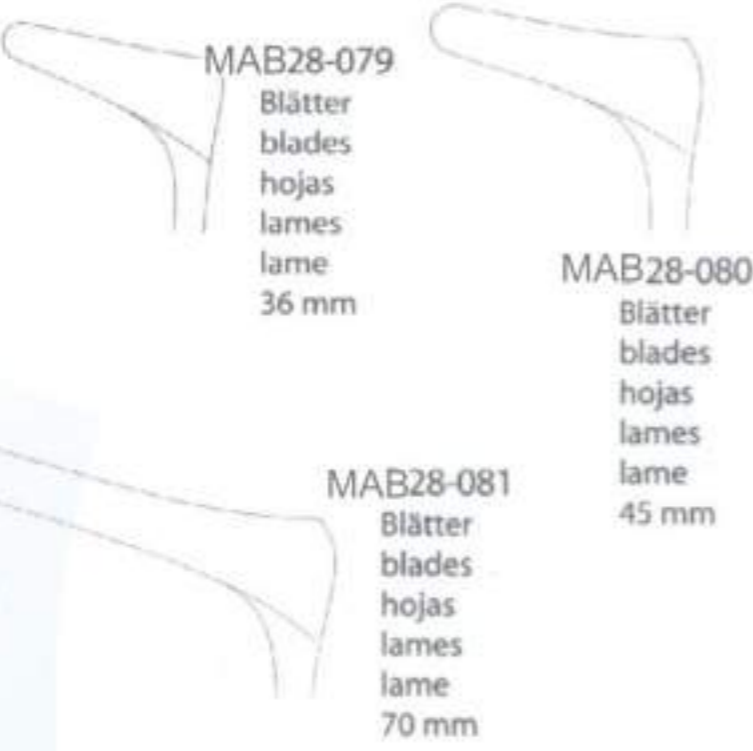

Kranio-Maxillofaziale Chirurgie . Chirurgie du crâne et maxillo-faciale . Chirurgia cranio-maxillo-facciale  
 Osteotome  
 Osteotomes  
 Osteótomos  
 Osteótomos  
 Osteótomi

Kranio-Maxillofaziale Chirurgie . Cranio-Maxillo-Facial Surgery . Cirugia craneo-maxilofacial  
 Osteotome  
 Osteotomes  
 Osteótomos  
 Osteótomos  
 Osteótomi

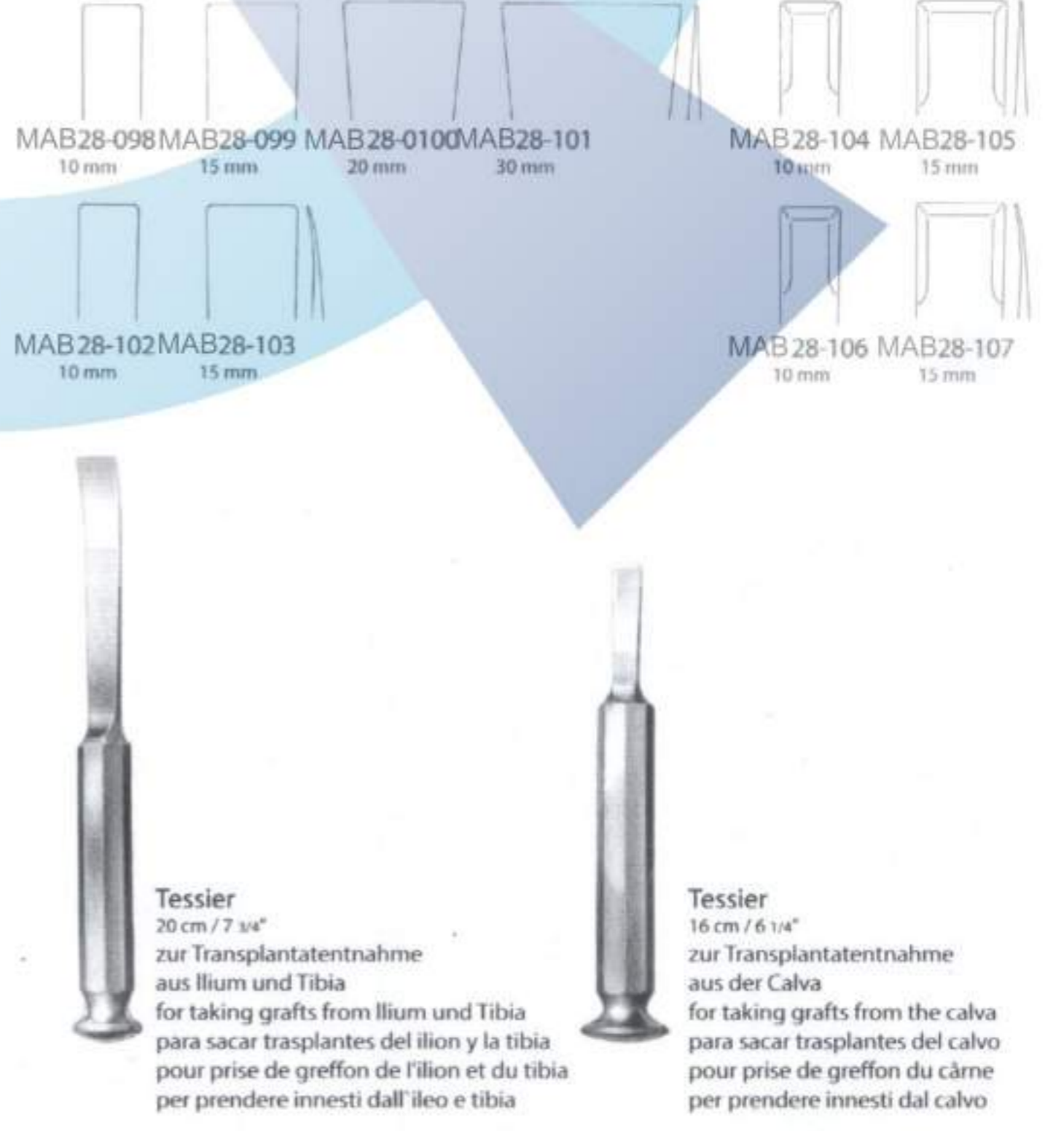
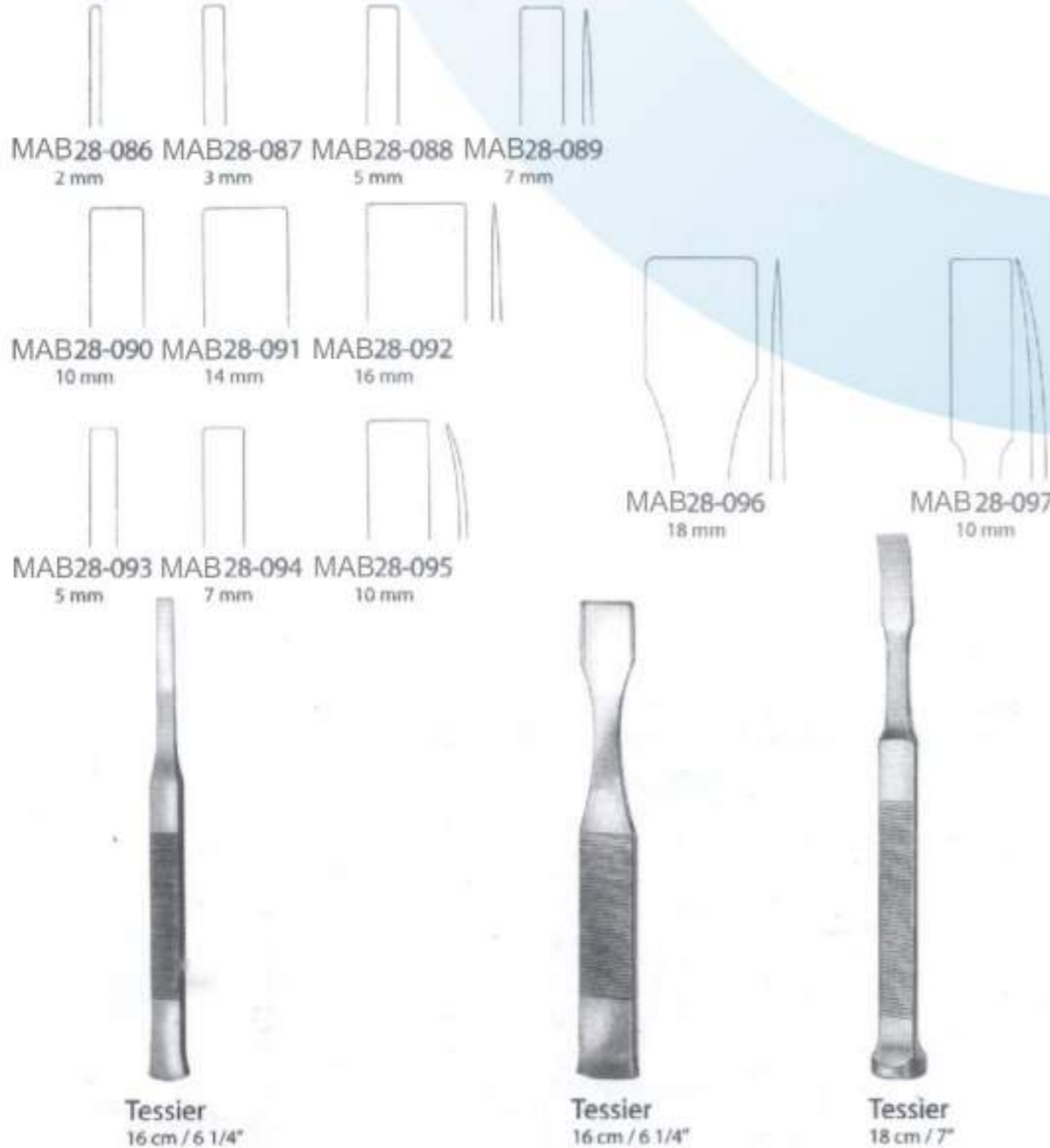



Kranio-Maxillofaziale Chirurgie . Chirurgie du crâne et maxillo-faciale . Chirurgia cranio-maxillo-facciale  
 Thoraxhaken  
 Thoracic Retractors  
 Separadores torácico  
 Rétracteur thoracique  
 Divaricatore per torace



.Chirurgie du crâne et maxillo-faciale . Chirurgia cranio-maxillo-facciale

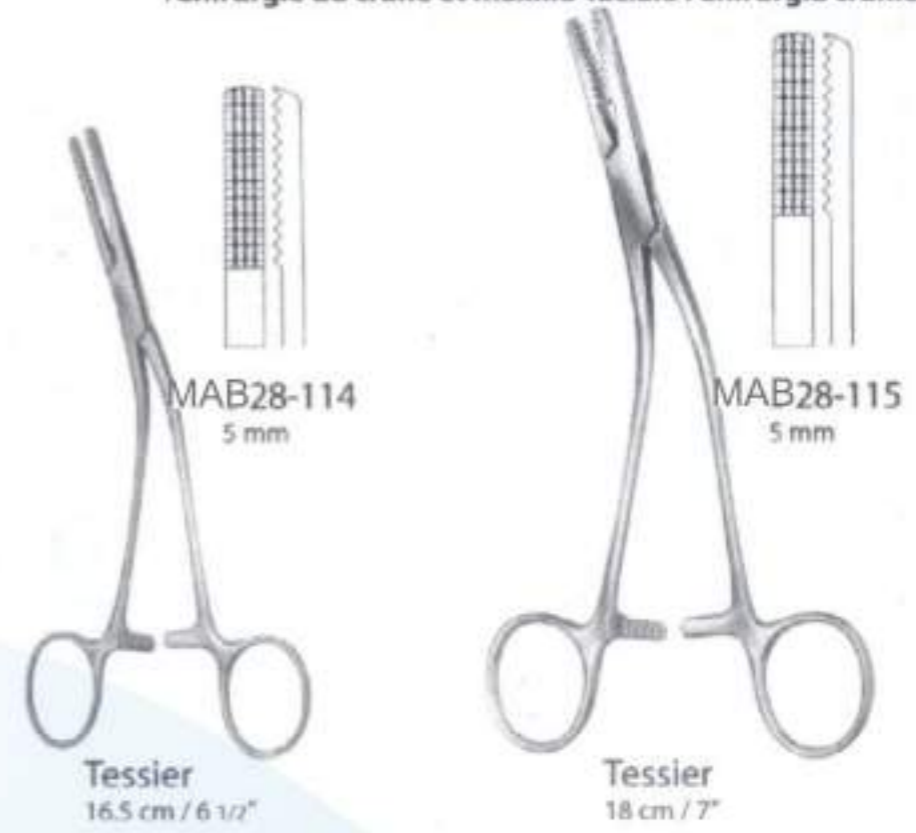

Kranio-Maxillofaziale Chirurgie . Cranio-Maxillo-Facial Surgery . Cirugia craneo-maxilofacial  
 Beckenkammspatel  
 Iliac Crest Retractors  
 Separadores para cresta iliaca  
 Rétracteur iliaque  
 Divaricatore per cresta iliaca

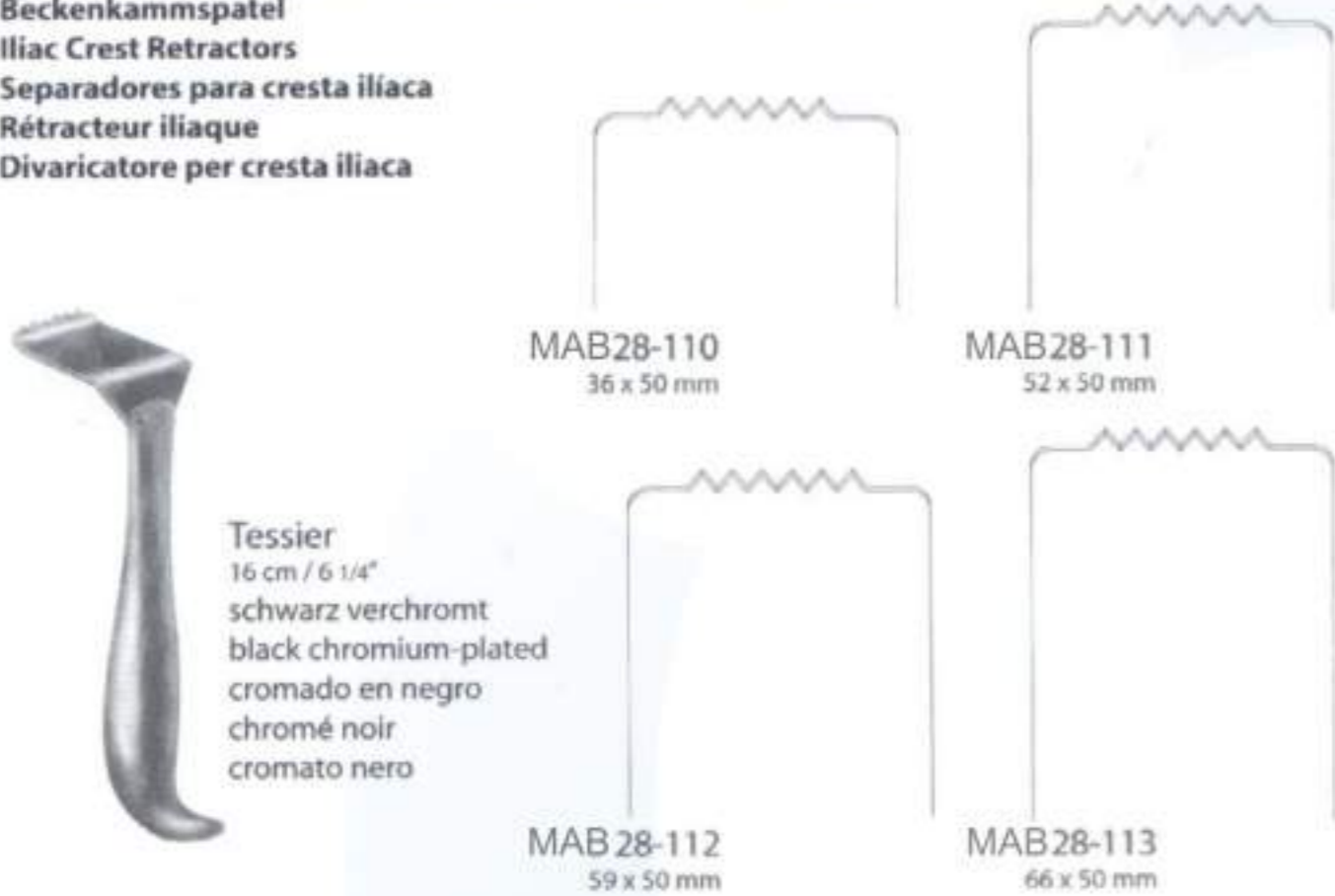

Kranio-Maxillofaziale Chirurgie . Cranio-Maxillo-Facial Surgery . Cirugia craneo-maxilofacial  
 Knochenscheidezangen  
 Bone Cutting Forceps  
 Pinzas para cortar huesos  
 Pinces coupantes à os  
 Pinze per tagliare osso



Kranio-Maxillofaziale Chirurgie . Chirurgie du crâne et maxillo-faciale . Chirurgia cranio-maxillo-facciale  
 Knochensplitterzangen  
 Bone Cutting Forceps  
 Cizallas para huesos  
 Pinces coupantes à os  
 Pinze per ossa

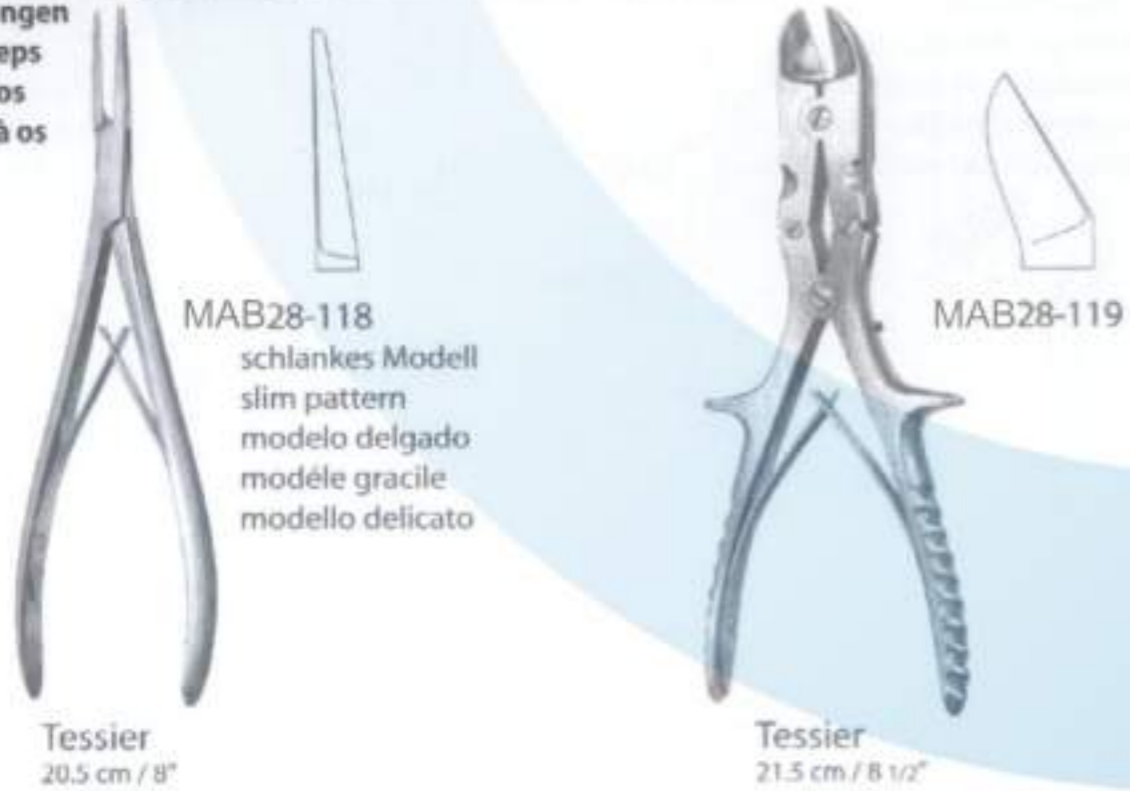

Kranio-Maxillofaziale Chirurgie . Chirurgie du crâne et maxillo-faciale . Chirurgia cranio-maxillo-facciale  
 Periostaspatorien  
 Periosteal Elevators  
 Legras para periostio  
 Rugine-raspatoires pour périoste  
 Elevatori periostali

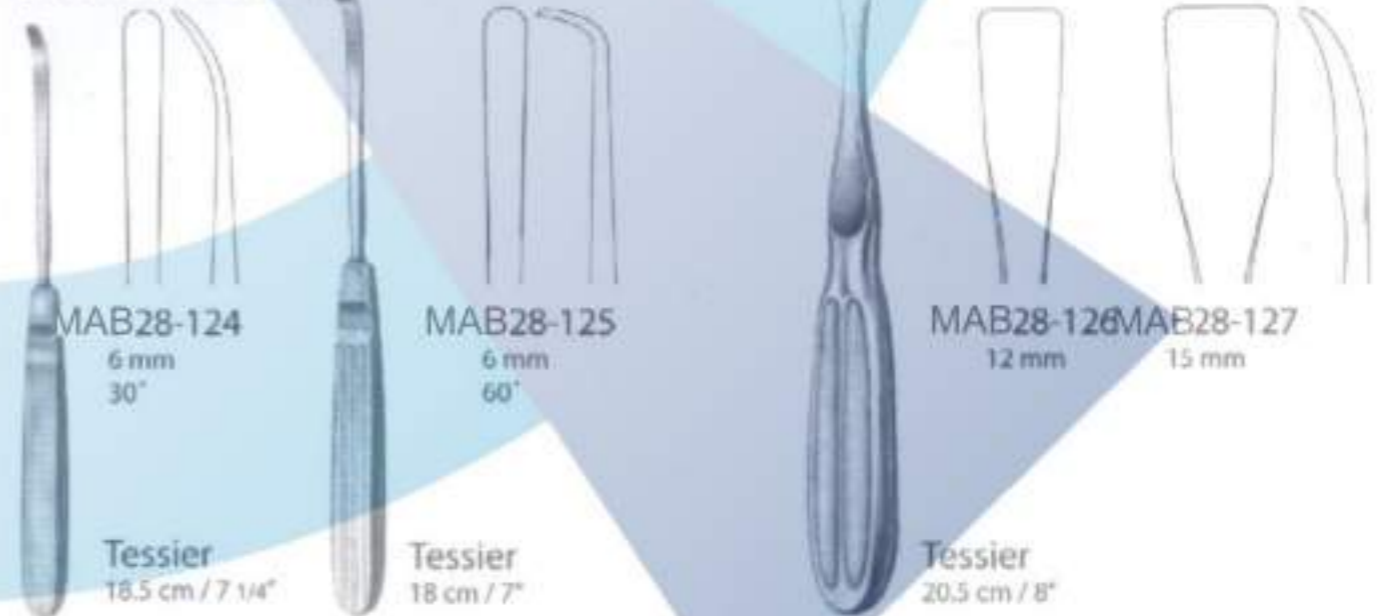

Kranio-Maxillofaziale Chirurgie . Cranio-Maxillo-Facial surgery . Cirugia craneo-maxilofacial  
 Beckenkamm-Ahlen  
 Iliac Crest Awls  
 Leznas para cresta iliaca  
 Alène pour os iliaques  
 Punteruoli per cresta iliaca



Kranio-Maxillofaziale Chirurgie . Cranio-Maxillo-Facial Surgery . Cirugia craneo-maxilofacial  
 Ahlen  
 Awls  
 Leznas  
 Alènes  
 Punteruoli

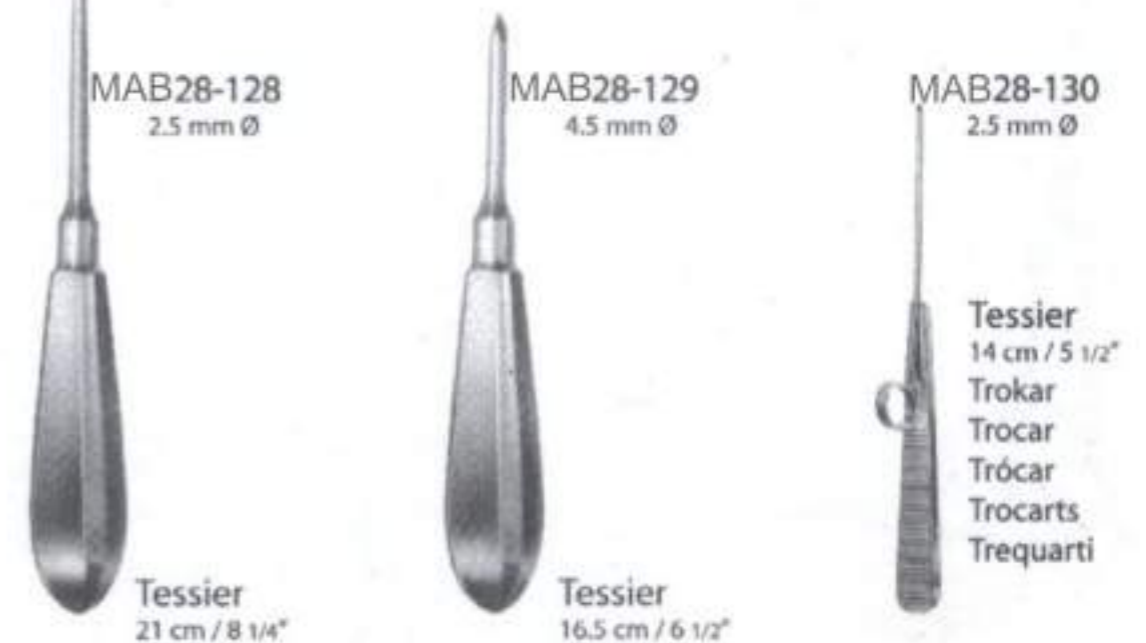



**Kranio-Maxillofaziale Chirurgie . Chirurgie du crâne et maxillo-faciale . Chirurgia cranio-maxillo-facciale**

**Sattelhäkchen  
Saddle Hooklets  
Ganchitos en forma de silla  
Crochet sous forme de selle  
Guanci a forma di sella**

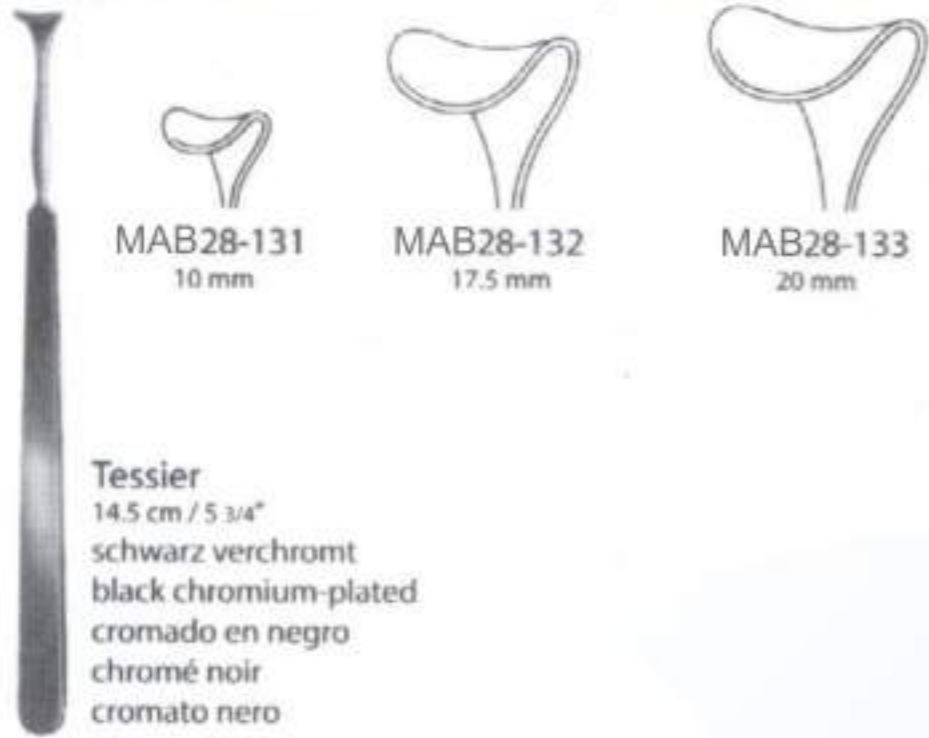

**Kranio-Maxillofaziale Chirurgie . Cranio-Maxillo-Facial Surgery . Cirugía craneo-maxilofacial**

**Osteotome  
Osteotomes  
Osteótomos  
Ostéotomes  
Osteotomi**

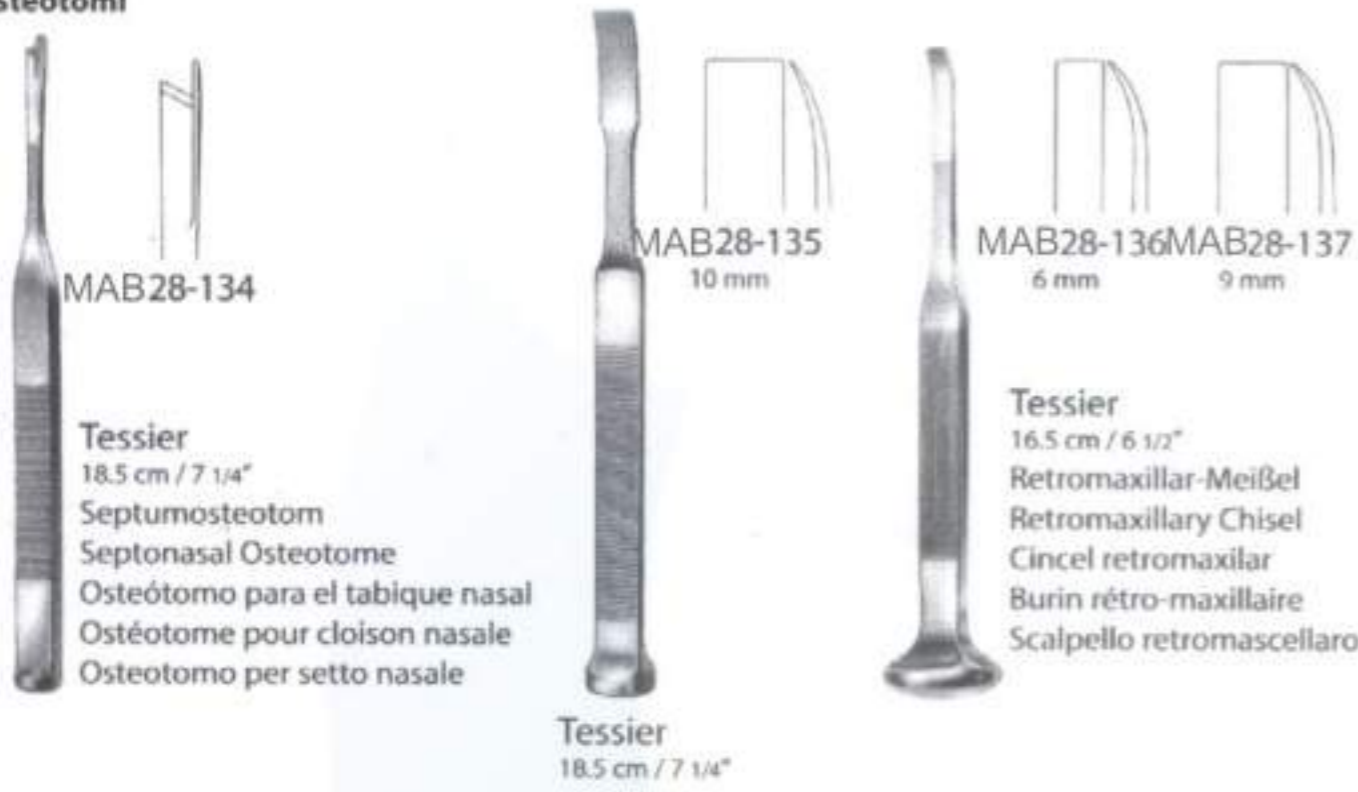

**Kranio-Maxillofaziale Chirurgie . Cranio-Maxillo-Facial Surgery . Cirugía craneo-maxilofacial**

**Repositionzangen  
Disimpaction Forceps  
Pinzas de reposición  
Pinçe à repositionner  
Pinze per riduzione**

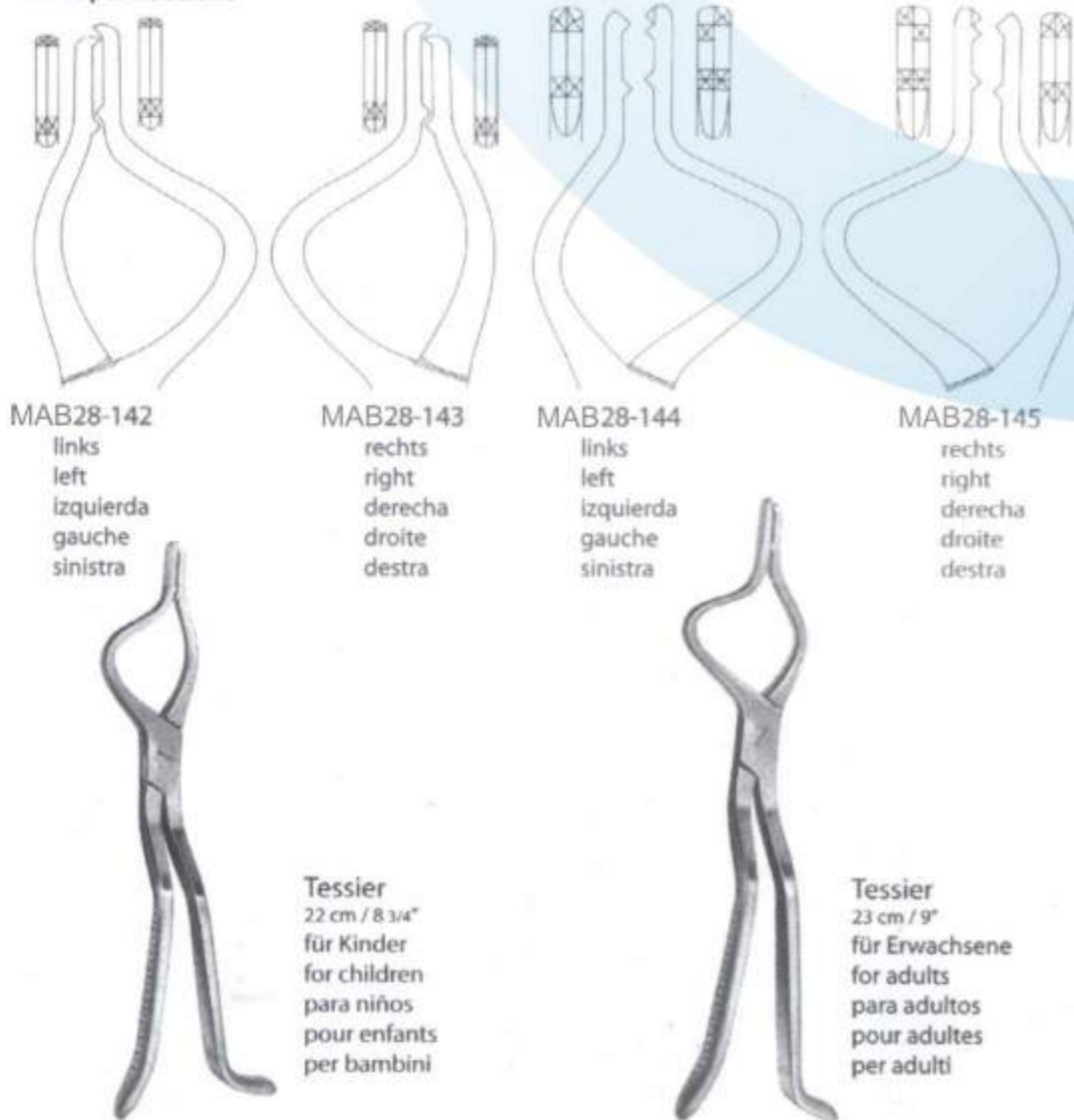

**Kranio-Maxillofaziale Chirurgie . Chirurgie du crâne et maxillo-faciale . Chirurgia cranio-maxillo-facciale**

**Präparierscheren, Drahtschere  
Dissecting Scissors, Wire Cutting Scissors  
Tijeras para preparaciones, Tijeras para alambre  
Ciseaux à dissection, Ciseaux à couper le fil  
Forbici per dissezione, Tronchesino**



**Kranio-Maxillofaziale Chirurgie . Cranio-Maxillo-Facial Surgery . Cirugía craneo-maxilofacial**

**Mobilisierhaken  
Mobilizing Retractors  
Separadores de movilización  
Crochet de mobilisation  
Divaricatori per mobilizzazione**



**Kranio-Maxillofaziale Chirurgie . Chirurgie du crâne et maxillo-faciale . Chirurgia cranio-maxillo-facciale**

**Raspatorien  
Periosteal Elevators  
Legras para periostio  
Rugine-raspatoires pour périoste  
Elevatori periostali**

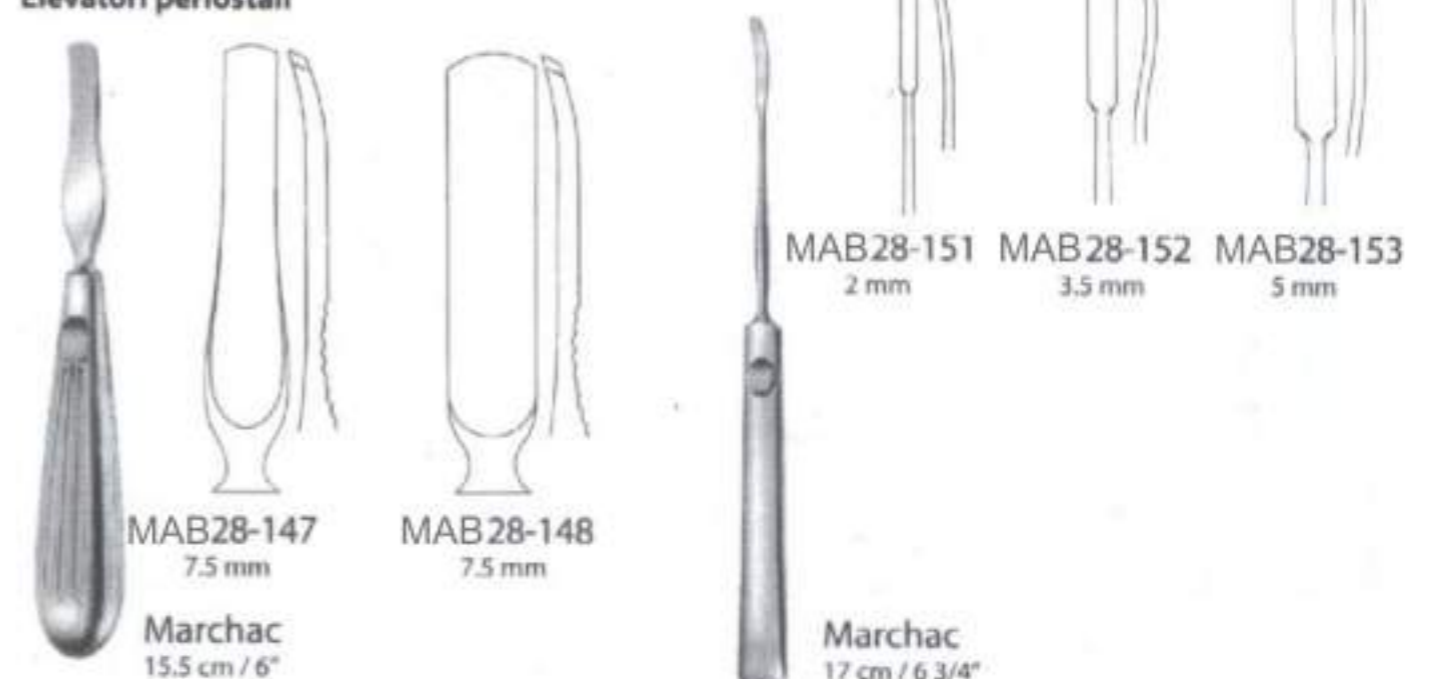





Marchac MAB28-148 18 cm / 7" graduert graduated graduado gradué graduato  
 Marchac MAB28-149 13 cm / 5"  
 Marchac MAB28-150 13.5 cm / 5 1/4"  
 Marchac MAB28-151 11 cm / 4 1/4" graduert graduated graduado gradué graduato

Feile, Messlehre, Knochenhaltezeuge  
 File, Caliper, Bone Holding Forcep  
 Lima, Caliper, Pinzas para huesos  
 Lime, Calibre, Daviers Porte-os  
 Lima, Calibro, Pinza per ossa

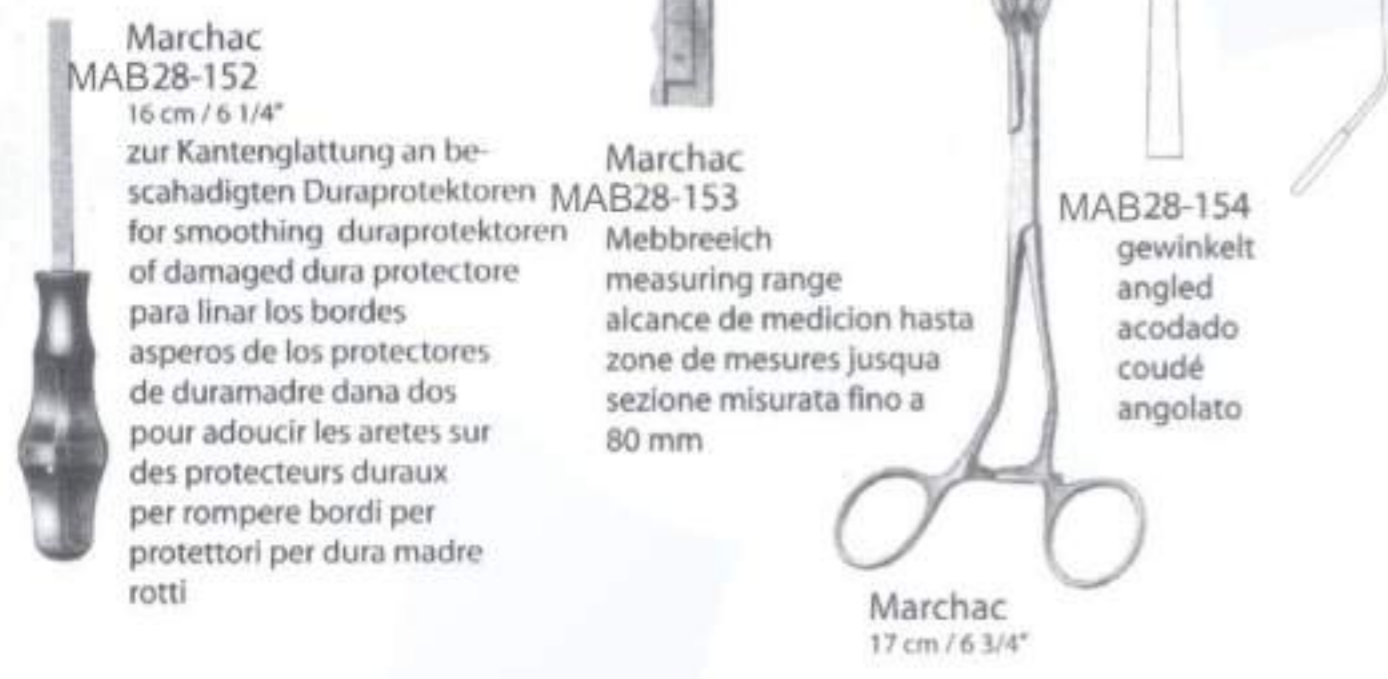

Marchac MAB28-152 16 cm / 6 1/4" zur Kantenglättung an beschadigten Duraprotektoren for smoothing duraprotektoren of damaged dura protectore para linar los bordes asperos de los protectores de duramadre dana dos pour adoucir les aretes sur des protecteurs duraux per rompere bordi per protettori per dura madre rotti  
 Marchac MAB28-153 Mebbereich measuring range alcance de medicion hasta zone de mesures jusqu'a sezione misurata fino a 80 mm  
 Marchac MAB28-154 gewinkelt angled acodado coudé angolato  
 Marchac 17 cm / 6 3/4"

## MAB 29

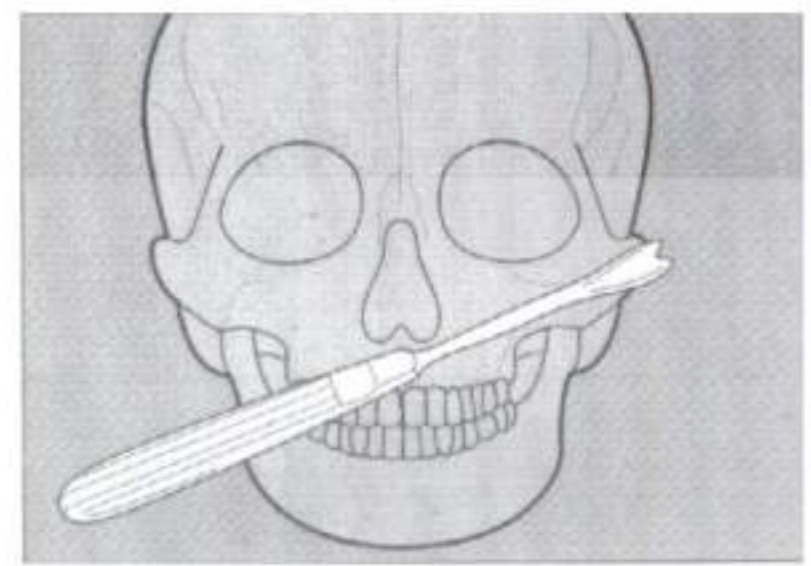

Aspiration-Dissektor, Osteotome  
 Suction Dissector, Osteotomes  
 Disecador de aspiracion, Osteotomos  
 Dissecteru a aspiration, Osteotomes  
 Dissettore a aspirazione, Osteotomi

Aspirations-Dissektor, Osteotome  
 Suction Dissector, Osteotomes  
 Disecador de aspiracion, Osteotomos  
 Dissecteru a aspiration, Osteotomes  
 Dissettore a aspirazione, Osteotomi

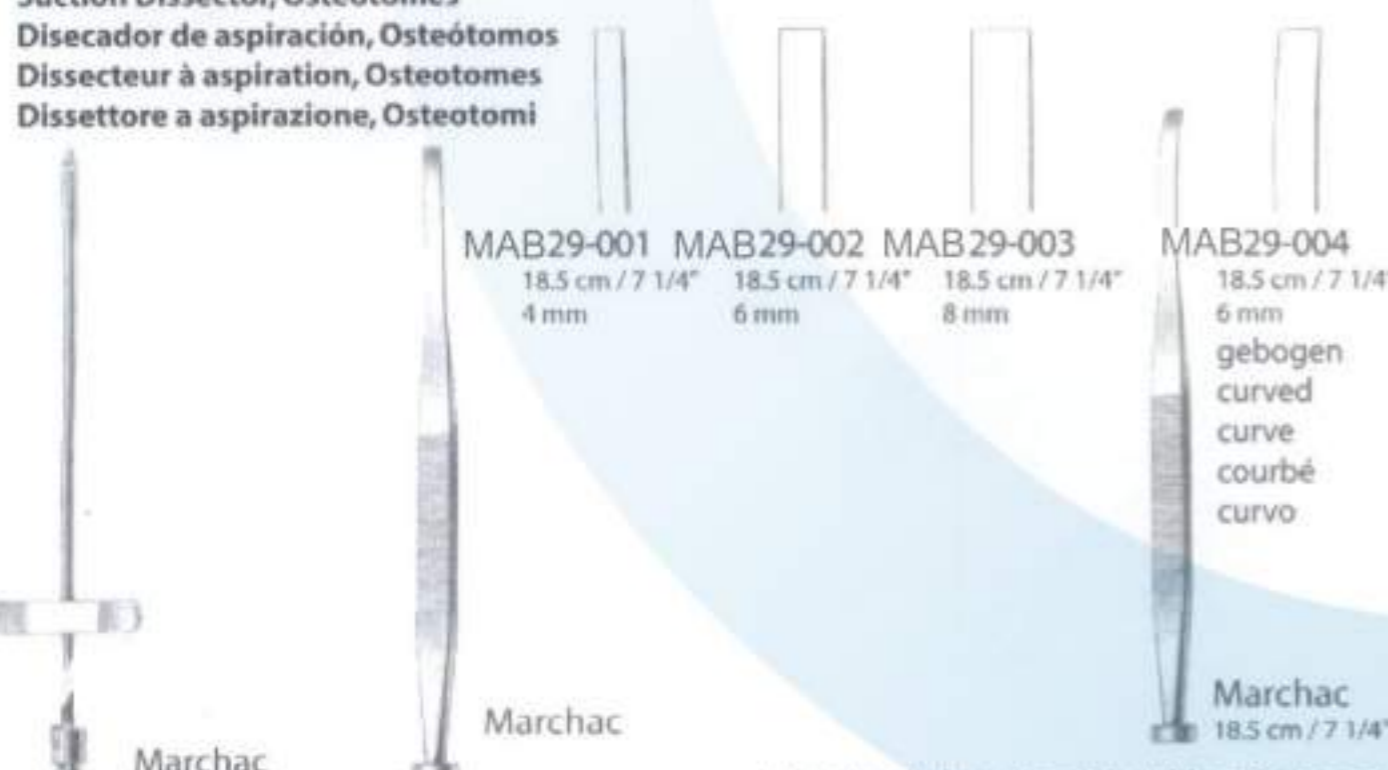

MAB29-001 18.5 cm / 7 1/4" 4 mm  
 MAB29-002 18.5 cm / 7 1/4" 6 mm  
 MAB29-003 18.5 cm / 7 1/4" 8 mm  
 MAB29-004 18.5 cm / 7 1/4" 6 mm gebogen curved curve courbé curvo  
 Marchac 18.5 cm / 7 1/4"  
 Marchac MAB29-005 19 cm / 7 1/2"

Knochenhaken, Cranial-Hohlmeißelzange  
 Bone Hook, Cranial Rongeur  
 Gancho de huesos, Pinza gubia craneal  
 Crochet pour os, Gouge craniale  
 Uncino per ossa, Sgorbia craniale

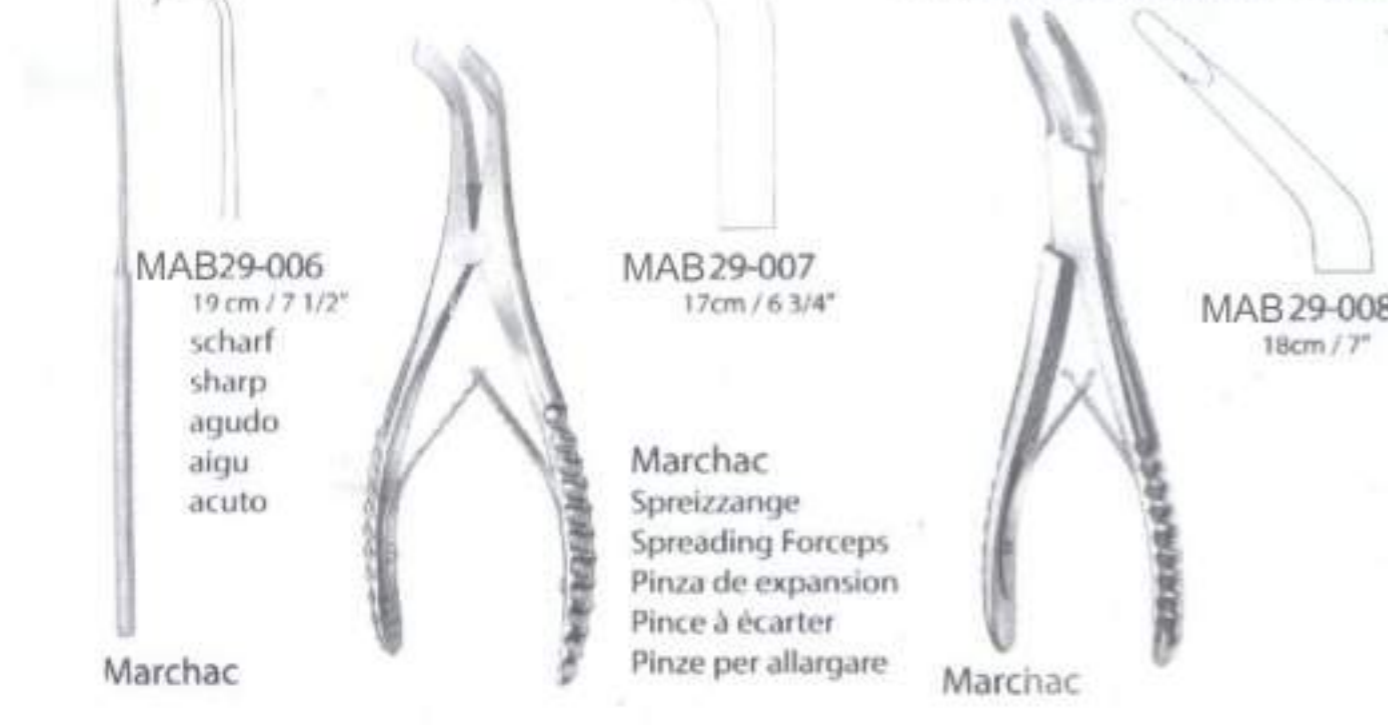

Marchac MAB29-006 19 cm / 7 1/2" scharf sharp agudo acuto  
 Marchac MAB29-007 17 cm / 6 3/4"  
 Marchac MAB29-008 18 cm / 7"  
 Marchac Spreizzange Spreading Forceps Pinza de expansion Pince à écarter Pinze per allargare

Repositionszange  
 Disimpaction Forceps  
 Pinza de reposición  
 Pince de reposition  
 Pinza per riposizione  
 Duraprotektor / Drahtfänger  
 Dura Protector / Wire Catcher  
 Protector para duramadre / Captador de alambre  
 Protecteur pour dure-mère / Capteur de fil  
 Protettore per dura-madre / Portalegature



Marchac MAB29-009 23 cm / 9" für Kinder for children prar niños pour enfants per bambini  
 Marchac MAB29-010 21.5 cm / 8 1/2"

Knochenformazange  
 Bone Contouring Forceps  
 Pinza para formar huesos  
 Pince per former os  
 Pinza per formare ossa



Marchac MAB29-011 18 cm / 7" 6.5 mm konvex / konkav convex / cóncave cocexo / concavo convexe / concesso für Kinder for children para niños por enfants per bambini  
 Marchac MAB29-012 18 cm / 7" 11 mm konvex / konkav convex / cóncave cocexo / concavo convexe / concesso für Kinder for children para niños por enfants per bambini



MAB 30

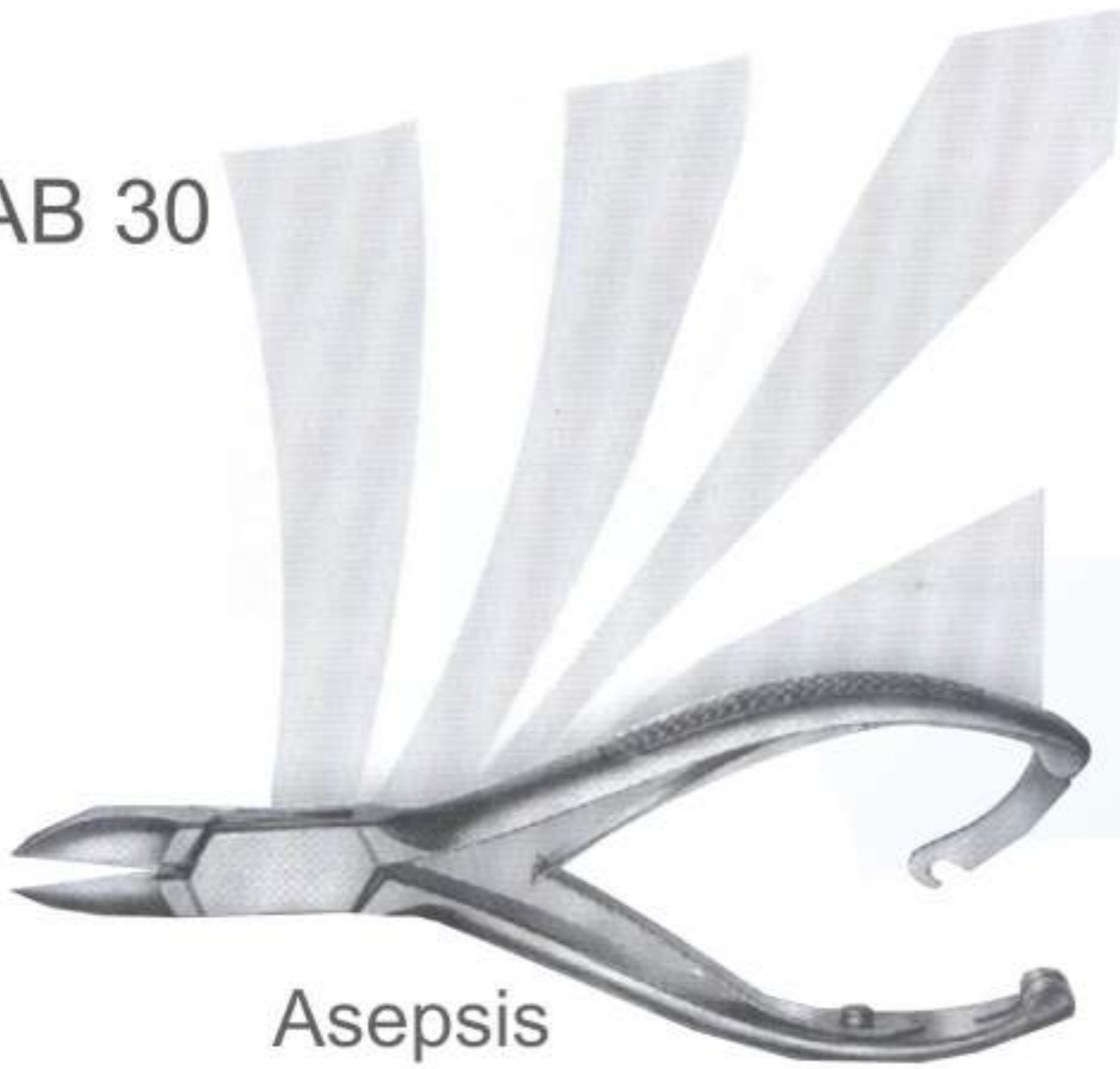

Asepsis  
Asepsis  
Asepsia  
Asepsie  
Asepsi

Asepsis . Asepsis . Asepsia  
Nagelscheren, Nagelzangen  
Nail Scissors, Nail Nippers  
Tijeras para uñas, Pinzas para cortar uñas  
Ciseaux à ongles, Pinces pour couper ongles  
Forbici per unghie, Tronchesine per unghie

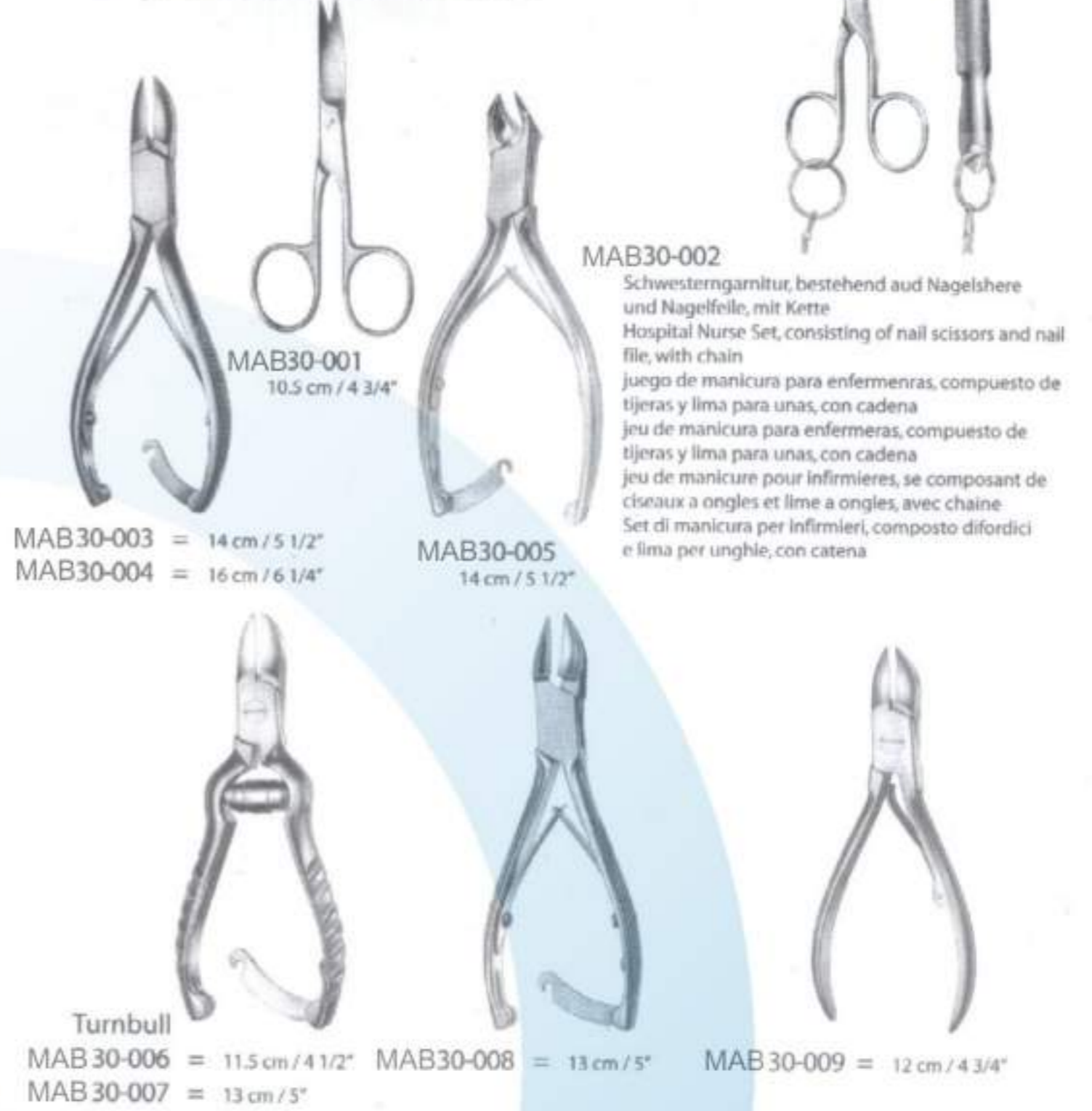

MAB30-001 = 10.5 cm / 4 3/4"  
MAB30-003 = 14 cm / 5 1/2"  
MAB30-004 = 16 cm / 6 1/4"

MAB30-002  
Schwesterngarnitur, bestehend aus Nagelschere und Nagelfeile, mit Kette  
Hospital Nurse Set, consisting of nail scissors and nail file, with chain  
juego de manicura para enfermeras, compuesto de tijeras y lima para uñas, con cadena  
jeu de manicure pour infirmières, se composant de ciseaux à ongles et lime à ongles, avec chaîne  
Set di manicura per infermieri, composto di forbici e lima per unghie, con catena

Turnbull  
MAB 30-006 = 11.5 cm / 4 1/2"  
MAB30-007 = 13 cm / 5"  
MAB30-008 = 13 cm / 5"  
MAB 30-009 = 12 cm / 4 3/4"

Asepsis . Asepsie . Asepsi  
Nageleckenzangen, Nagelhautzangen, Hautscheren, Nagelfeilen  
Nail Nippers, Cuticle Nippers, Cuticle Scissors, Nail Files  
Pinzas para cortar uñas, Pinzas cuticulares, Tijeras cuticulares, Limas para uñas  
Pinces pour couper ongles, Pinces à envies, Ciseaux à envies, Limes à ongles  
Tronchesine per unghie, Tronchesine per pelle, Forbici per pelle, Lime per unghie



gerade Schneiden  
straight cutting edges  
hojas cortantes rectas  
lames tranchantes droites  
parte tagliente diritta

feines Modell  
delicate pattern  
modelo delicado  
mcodele fin  
modello fino

feines Modell  
delicate pattern  
modelo delicado  
mcodele fin  
modello fino

MAB 30-010 = 11 cm / 4 1/4" MAB30-013 = 11 cm / 4" MAB30-015 = 10.5 cm / 4" MAB30-016 = 10.5 cm / 4 1/2"  
MAB 30-011 = 13 cm / 5" MAB30-014 = 13 cm / 5" MAB30-017 = 12 cm / 4 3/2"

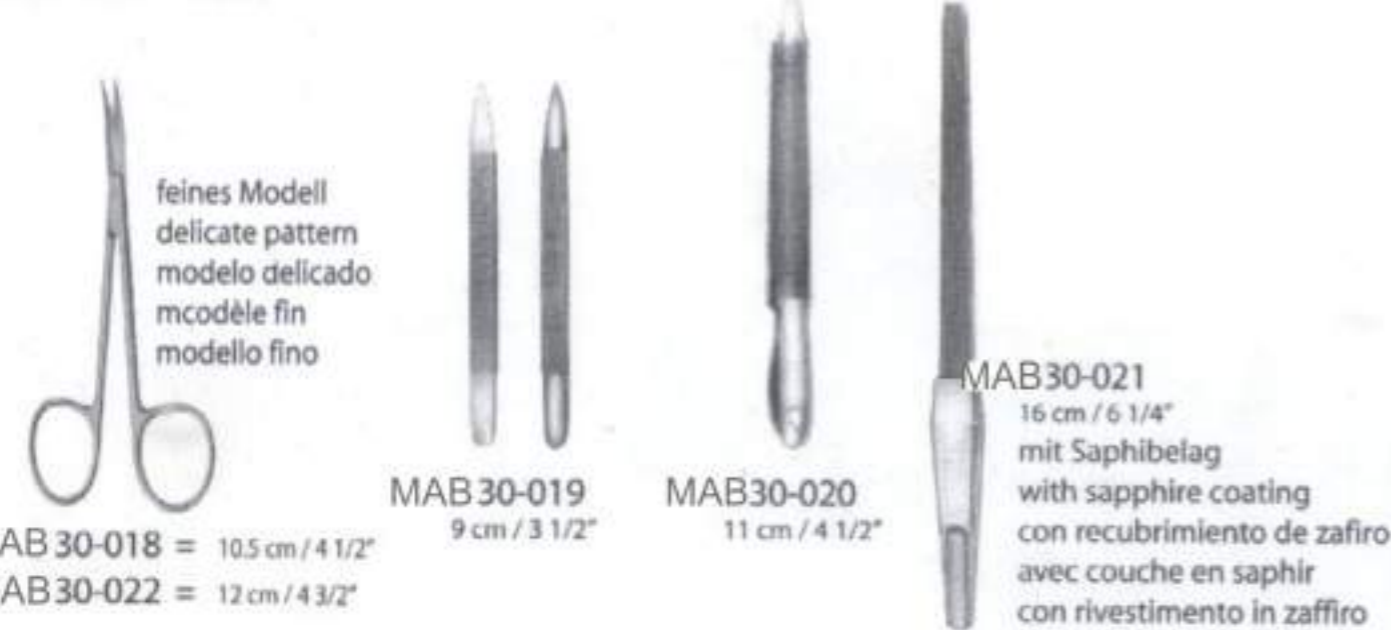

feines Modell  
delicate pattern  
modelo delicado  
mcodele fin  
modello fino

MAB 30-018 = 10.5 cm / 4 1/2"  
MAB30-022 = 12 cm / 4 3/2"

MAB30-019 = 9 cm / 3 1/2"  
MAB30-020 = 11 cm / 4 1/2"

MAB30-021  
16 cm / 6 1/4"  
mit Saphibelag  
with sapphire coating  
con recubrimiento de zafiro  
avec couche en saphir  
con rivestimento in zaffiro

MABSON INDUSTRY





# MABSON INDUSTRY

Manufacturer & Exporter of Surgical, Dental & Orthopedic Instruments



**MABSON INDUSTRY™**

[WWW.MABSONORTHO.COM](http://WWW.MABSONORTHO.COM)

Tel: +92 52 3570603

Fax: +92 52 3570604

Moh. Islamabad Union Council  
Near Imran Market Ugoki Morre,  
Sialkot-51310 Pakistan