



MABSON ORTHO

# MABSON INDUSTRY

Manufacturer & Exporter of Surgical, Dental & Orthopedic Instruments



Web: [www.mabsonortho.com](http://www.mabsonortho.com)

Tel: +92 52 3570603  
Fax: +92 52 3570604  
Moh. Islamabad Union Council  
Near Imran Market Ugoki Morre,  
Sialkot-51310 Pakistan.



MABSON ORTHO

# MABSON INDUSTRY

Manufacturer & Exporter of Surgical, Dental & Orthopedic Instruments

## Root Elevators Set, Extraction Set



Set - 01

### KIT ROOT ELEVATORS (Complete Set of 6 Pcs.)

- |    |                       |         |
|----|-----------------------|---------|
| 01 | ROOT ELEVATORS APICAL | Fig.301 |
| 02 | ROOT ELEVATORS APICAL | Fig.302 |
| 03 | ROOT ELEVATORS APICAL | Fig.303 |
| 04 | ROOT ELEVATORS SELDIN | Fig.34S |
| 05 | ROOT ELEVATORS CRYER  | Fig.44  |
| 06 | ROOT ELEVATORS CRYER  | Fig.45  |



Set - 02

### EXTRACTION AND ORAL SURGERY (Complete Set of 9Pcs.)

- |    |                          |          |
|----|--------------------------|----------|
| 01 | EXTRACTING FORCEPS       | Fig. 67A |
| 02 | EXTRACTING FORCEPS       | Fig. 51A |
| 03 | EXTRACTING FORCEPS       | Fig. 33  |
| 04 | EXTRACTING FORCEPS       | Fig. 79  |
| 05 | ROOT ELEVATORS FLOHR     | Fig. 20  |
| 06 | ROOT ELEVATORS FLOHR     | Fig. 238 |
| 07 | ROOT ELEVATORS FLOHR     | Fig. 239 |
| 08 | MAYO HEGAR NEEDLE HOLDER | 16 cm    |
| 09 | MATHIEU NEEDLE HOLDER    | 14 cm    |



Web: [www.mabsonortho.com](http://www.mabsonortho.com)

Tel: +92 52 3570603  
Fax: +92 52 3570604  
Moh. Islamabad Union Council  
Near Imran Market Ugoki Morre,  
Sialkot-51310 Pakistan.



MABSON ORTHO

# MABSON INDUSTRY

Manufacturer & Exporter of Surgical, Dental & Orthopedic Instruments

## Extraction Set

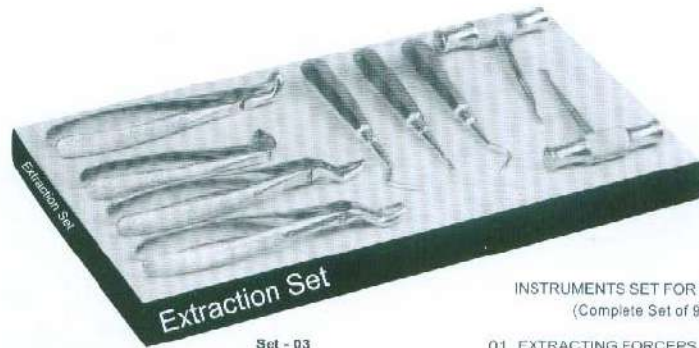

Set - 03

### INSTRUMENTS SET FOR EXTRACTION (Complete Set of 9 Pcs.)

01	EXTRACTING FORCEPS	Fig. 67A
02	EXTRACTING FORCEPS	Fig. 51A
03	EXTRACTING FORCEPS	Fig. 33
04	EXTRACTING FORCEPS	Fig. 79
05	ROOT ELEVATORS FLOHR	Fig. 20
06	ROOT ELEVATORS FLOHR	Fig. 238
07	ROOT ELEVATORS FLOHR	Fig. 239
08	ROOT ELEVATORS WINTER	Fig. 320
09	ROOT ELEVATORS WINTER	Fig. 321



Set - 04

### INSTRUMENTS SET FOR EXTRACTION (Complete Set of 8 Pcs.)

01	EXTRACTING FORCEPS	Fig. 1
02	EXTRACTING FORCEPS	Fig. 17
03	EXTRACTING FORCEPS	Fig. 18
04	EXTRACTING FORCEPS	Fig. 79
05	EXTRACTING FORCEPS	Fig. 67A
06	EXTRACTING FORCEPS	Fig. 51A
07	EXTRACTING FORCEPS	Fig. 13
08	EXTRACTING FORCEPS	Fig. 22



Web: [www.mabsonortho.com](http://www.mabsonortho.com)

Tel: +92 52 3570603  
Fax: +92 52 3570604  
Moh. Islamabad Union Council  
Near Imran Market Ugoki Morre,  
Sialkot-51310 Pakistan.



MABSON ORTHO

**MABSON  
INDUSTRY**

Manufacturer & Exporter of Surgical, Dental & Orthopedic Instruments

## Extraction Set

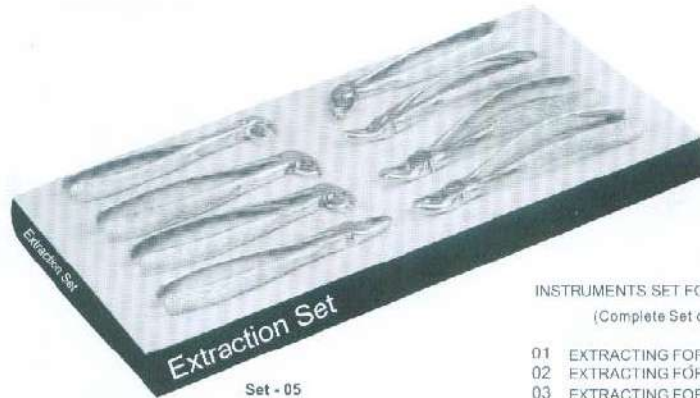

Set - 05

### INSTRUMENTS SET FOR EXTRACTION (Complete Set of 8 Pcs.)

- |    |                    |          |
|----|--------------------|----------|
| 01 | EXTRACTING FORCEPS | Fig. 1   |
| 02 | EXTRACTING FORCEPS | Fig. 17  |
| 03 | EXTRACTING FORCEPS | Fig. 18  |
| 04 | EXTRACTING FORCEPS | Fig. 79  |
| 05 | EXTRACTING FORCEPS | Fig. 67A |
| 06 | EXTRACTING FORCEPS | Fig. 51A |
| 07 | EXTRACTING FORCEPS | Fig. 13  |
| 08 | EXTRACTING FORCEPS | Fig. 22  |



Set - 06

### EXTRACTION FORCEPS FOR CHILDREN (Complete Set of 10 Pcs.)

- |    |                         |          |
|----|-------------------------|----------|
| 01 | EXTRACTING FORCEPS FINO | Fig. 37  |
| 02 | EXTRACTING FORCEPS FINO | Fig. 39  |
| 03 | EXTRACTING FORCEPS FINO | Fig. 39L |
| 04 | EXTRACTING FORCEPS FINO | Fig. 39R |
| 05 | EXTRACTING FORCEPS FINO | Fig. 51S |
| 06 | EXTRACTING FORCEPS FINO | Fig. 13S |
| 07 | EXTRACTING FORCEPS FINO | Fig. 30S |
| 08 | EXTRACTING FORCEPS FINO | Fig. 33S |
| 09 | EXTRACTING FORCEPS FINO | Fig. 22S |
| 10 | EXTRACTING FORCEPS FINO | Fig. 38  |



Web: [www.mabsonortho.com](http://www.mabsonortho.com)

Tel: +92 52 3570603  
Fax: +92 52 3570604  
Moh. Islamabad Union Council  
Near Imran Market Ugoki Morre,  
Sialkot-51310 Pakistan.



MABSON ORTHO

**MABSON  
INDUSTRY**

Manufacturer & Exporter of Surgical, Dental & Orthopedic Instruments

## Extraction Set



Set - 07

### INSTRUMENTS SET FOR EXTRACTING FORCEPS (Complete Set of 10 Pcs.)

- |    |                    |          |
|----|--------------------|----------|
| 01 | EXTRACTING FORCEPS | Fig. 2   |
| 02 | EXTRACTING FORCEPS | Fig. 7   |
| 03 | EXTRACTING FORCEPS | Fig. 51A |
| 04 | EXTRACTING FORCEPS | Fig. 17  |
| 05 | EXTRACTING FORCEPS | Fig. 18  |
| 06 | EXTRACTING FORCEPS | Fig. 67A |
| 07 | EXTRACTING FORCEPS | Fig. 13  |
| 08 | EXTRACTING FORCEPS | Fig. 33  |
| 09 | EXTRACTING FORCEPS | Fig. 22  |
| 10 | EXTRACTING FORCEPS | Fig. 79  |

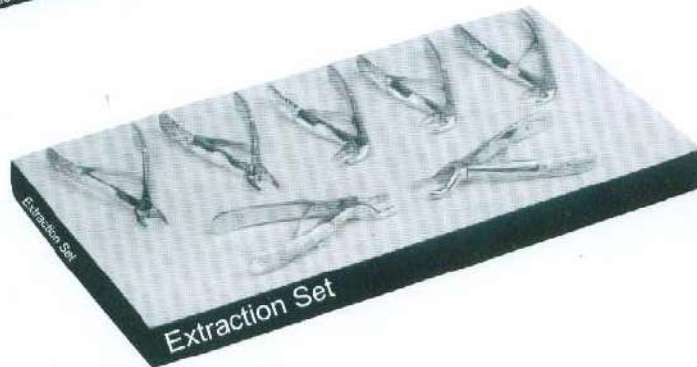

Set - 08

### EXTRACTING FORCEPS SET FOR CHILDREN KLEIN PATTERN (Complete Set of 7 Pcs.)

- |    |                             |          |
|----|-----------------------------|----------|
| 01 | EXTRACTING FORCEPS CHILDREN | Fig. 5   |
| 02 | EXTRACTING FORCEPS CHILDREN | Fig. 6   |
| 03 | EXTRACTING FORCEPS CHILDREN | Fig. 7   |
| 04 | EXTRACTING FORCEPS CHILDREN | Fig. 137 |
| 05 | EXTRACTING FORCEPS CHILDREN | Fig. 139 |
| 06 | EXTRACTING FORCEPS CHILDREN | Fig. 3   |
| 07 | EXTRACTING FORCEPS CHILDREN | Fig. 51S |



Tel: +92 52 3570603

Fax: +92 52 3570604

Moh. Islamabad Union Council  
Near Imran Market Ugoki Morre,  
Sialkot-51310 Pakistan.

Web: [www.mabsonortho.com](http://www.mabsonortho.com)



MABSON ORTHO

# MABSON INDUSTRY

Manufacturer & Exporter of Surgical, Dental & Orthopedic Instruments

## Extracting Forceps (english pattern)

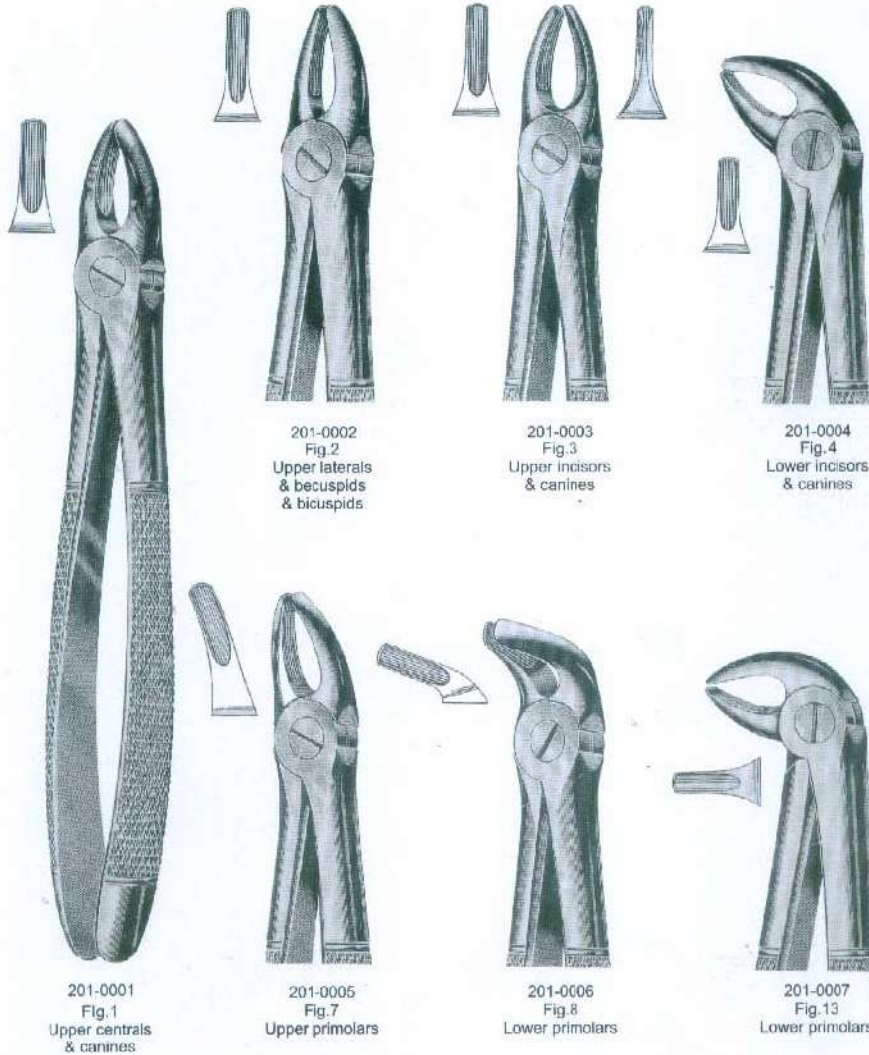

Web: [www.mabsonortho.com](http://www.mabsonortho.com)

Tel: +92 52 3570603  
Fax: +92 52 3570604  
Moh. Islamabad Union Council  
Near Imran Market Ugoki Morre,  
Sialkot-51310 Pakistan.



MABSON ORTHO

# MABSON INDUSTRY

Manufacturer & Exporter of Surgical, Dental & Orthopedic Instruments

## Extracting Forceps (english pattern)

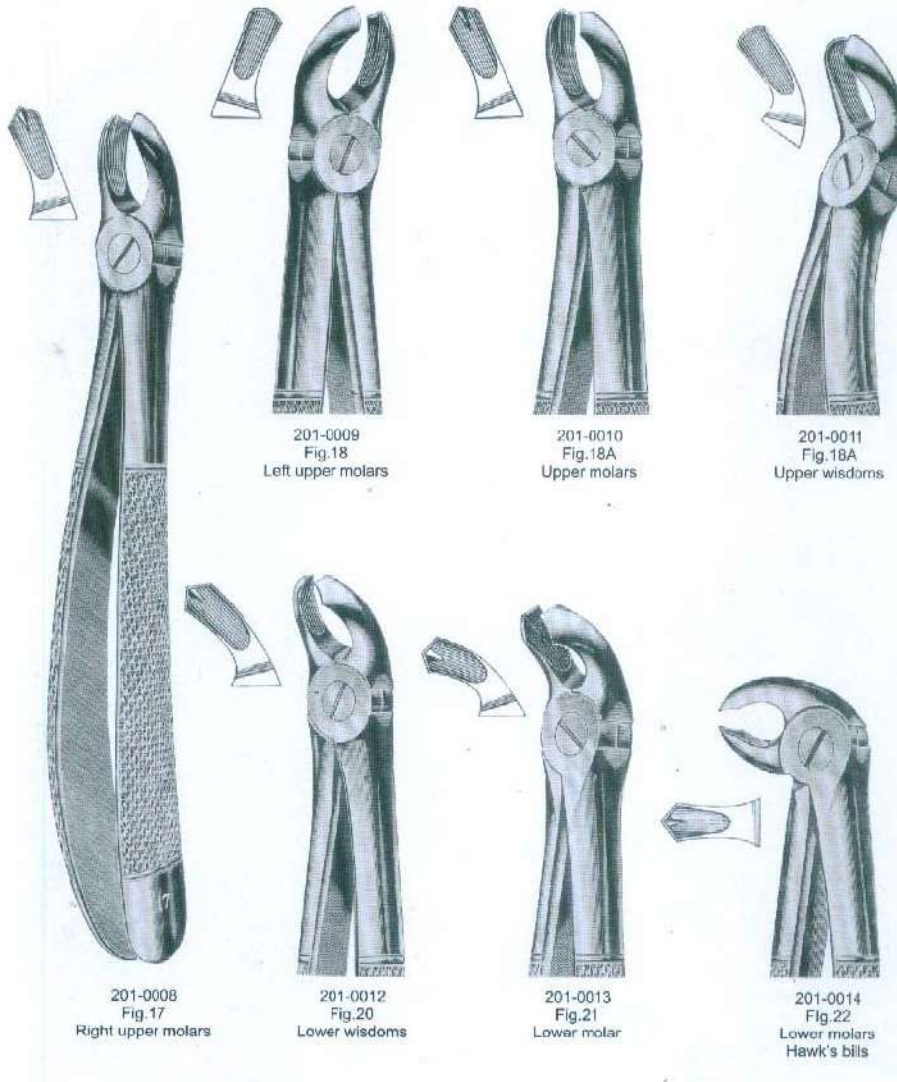

201-0009  
Fig.18  
Left upper molars

201-0010  
Fig.18A  
Upper molars

201-0011  
Fig.18A  
Upper wisdoms

201-0008  
Fig.17  
Right upper molars

201-0012  
Fig.20  
Lower wisdoms

201-0013  
Fig.21  
Lower molar

201-0014  
Fig.22  
Lower molars  
Hawk's bills

Web: [www.mabsonortho.com](http://www.mabsonortho.com)

Tel: +92 52 3570603  
Fax: +92 52 3570604  
Moh. Islamabad Union Council  
Near Imran Market Ugoki Morre,  
Sialkot-51310 Pakistan.



MABSON ORTHO

**MABSON  
INDUSTRY**

Manufacturer & Exporter of Surgical, Dental & Orthopedic Instruments

**Extracting Forceps  
(english pattern)**



201-0015  
Fig.23  
Right lower molars



201-0016  
Fig.24  
Left lower molars



201-0017  
Fig.29  
Upper root & incisors

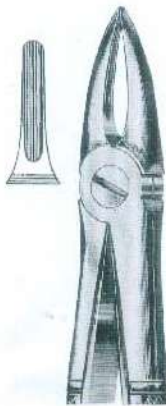

201-0018  
Fig.29N  
Roots of upper incisors



201-0019  
Fig.30  
Upper roots & incisors



201-0020  
Fig.31  
Lower roots



201-0021  
Fig.32  
Lower molars

Web: [www.mabsonortho.com](http://www.mabsonortho.com)

Tel: +92 52 3570603  
Fax: +92 52 3570604  
Moh. Islamabad Union Council  
Near Imran Market Ugoki Morre,  
Sialkot-51310 Pakistan.





MABSON ORTHO

# MABSON INDUSTRY

Manufacturer & Exporter of Surgical, Dental & Orthopedic Instruments

## Extracting Forceps (english pattern)

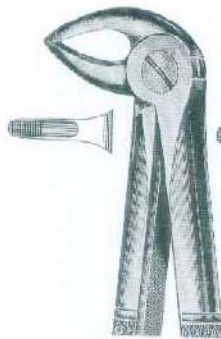

201-0022  
Fig.33  
Lower roots



201-0023  
Fig.33A  
Lower roots



201-0024  
Fig.33C  
Lower roots



201-0025  
Fig.33M  
Lower roots with long beak

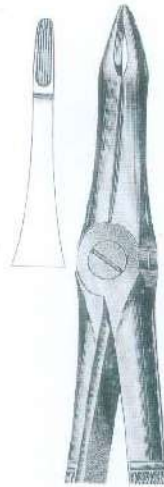

201-0026  
Fig.41  
Upper roots

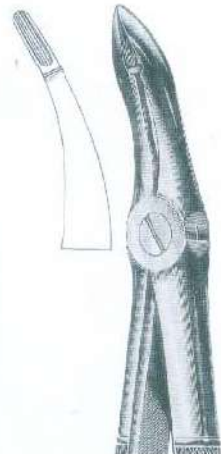

201-0027  
Fig.44  
Upper roots

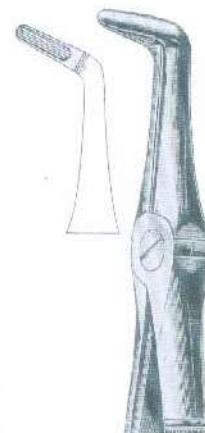

201-0028  
Fig.45  
Lower roots



201-0029  
Fig.51  
Upper roots

Web: [www.mabsonortho.com](http://www.mabsonortho.com)

Tel: +92 52 3570603  
Fax: +92 52 3570604  
Moh. Islamabad Union Council  
Near Imran Market Ugoki Morre,  
Sialkot-51310 Pakistan.



MABSON ORTHO

**MABSON  
INDUSTRY**

Manufacturer & Exporter of Surgical, Dental & Orthopedic Instruments

**Extracting Forceps  
(english pattern)**

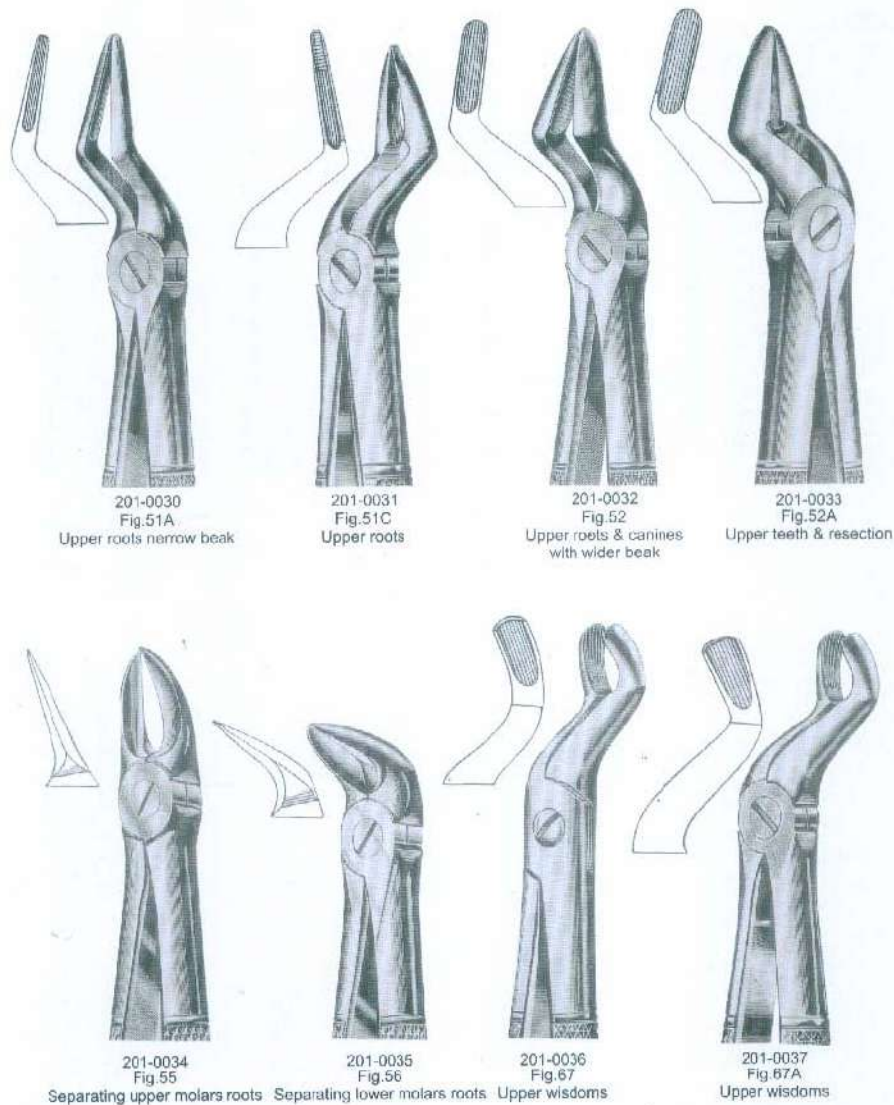

Web: [www.mabsonortho.com](http://www.mabsonortho.com)

Tel: +92 52 3570603  
Fax: +92 52 3570604  
Moh. Islamabad Union Council  
Near Imran Market Ugoki Morre,  
Sialkot-51310 Pakistan.



MABSON ORTHO

# MABSON INDUSTRY

Manufacturer & Exporter of Surgical, Dental & Orthopedic Instruments

## Extracting Forceps (english pattern)

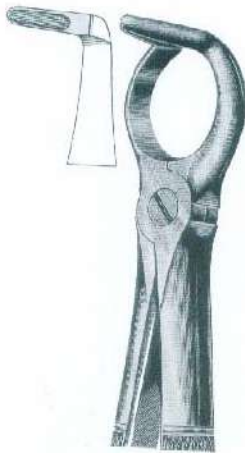

201-0038  
Fig.68  
Lower roots

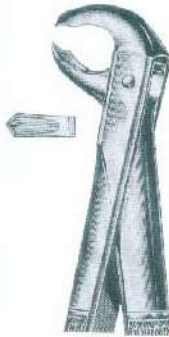

201-0039  
Fig.73  
Lower molars (hawk's bill)

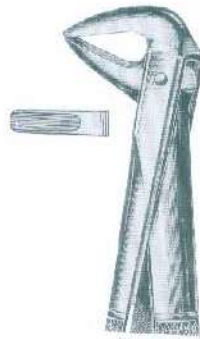

201-0040  
Fig.74  
Lower incisors & roots.



201-0041  
Fig.74M  
Lower incisors & roots



201-0042  
Fig.74N  
Lower incisors & roots

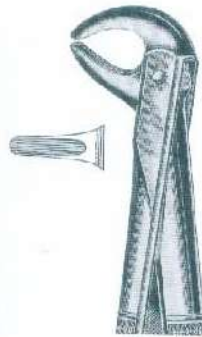

201-0043  
Fig.75  
Lower premolars & canines



201-0044  
Fig.76  
Upper roots

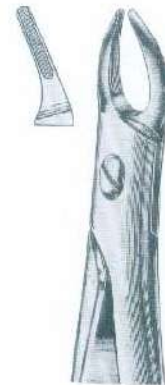

201-0045  
Fig.76N  
Upper roots  
Narrow break

Web: [www.mabsonortho.com](http://www.mabsonortho.com)

Tel: +92 52 3570603  
Fax: +92 52 3570604  
Moh. Islamabad Union Council  
Near Imran Market Ugoki Morre,  
Sialkot-51310 Pakistan.



MABSON ORTHO

# MABSON INDUSTRY

Manufacturer & Exporter of Surgical, Dental & Orthopedic Instruments

## Extracting Forceps (english pattern)

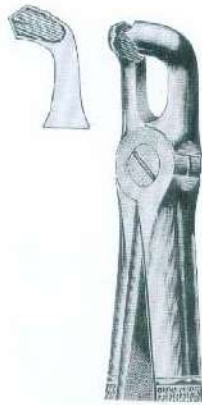

201-0046  
Fig. 79  
Lower wisdoms



201-0047  
Fig. 79A  
Lower wisdoms



201-0048  
Fig. 86A  
Lower molars



201-0049  
Fig. 86B  
Lower molars



201-0050  
Fig. 86C  
Lower molars

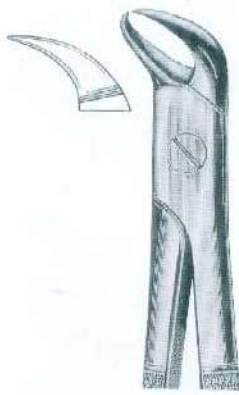

201-0051  
Fig. 87  
Cowhorn beak

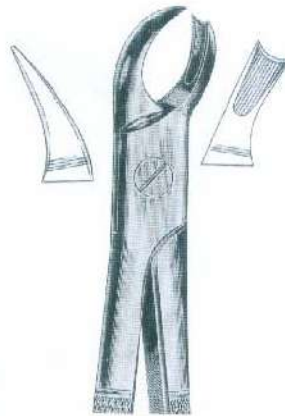

201-0052  
Fig. 89  
Right upper molars

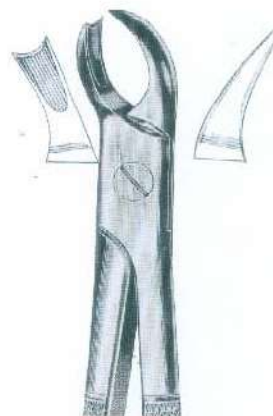

201-0053  
Fig. 9  
Left upper molars

Web: [www.mabsonortho.com](http://www.mabsonortho.com)

Tel: +92 52 3570603  
Fax: +92 52 3570604  
Moh. Islamabad Union Council  
Near Imran Market Ugoki Morre,  
Sialkot-51310 Pakistan.



MABSON ORTHO

# MABSON INDUSTRY

Manufacturer & Exporter of Surgical, Dental & Orthopedic Instruments

## Extracting Forceps (english pattern)

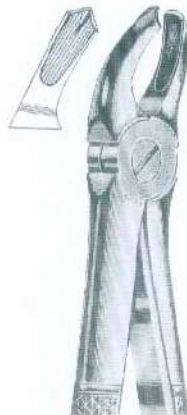

201-0054  
Fig.94  
Right upper molars



201-0055  
Fig.95  
Left upper molars



201-0056  
Fig.99  
Lower molars  
(broken-down)



201-0057  
Fig.99 1/4  
Lower molars  
(broken-down)

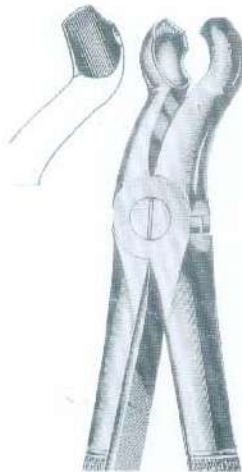

201-0058  
Fig.121  
Upper wisdoms



201-0059  
Fig.136  
Upper centrals  
& roots

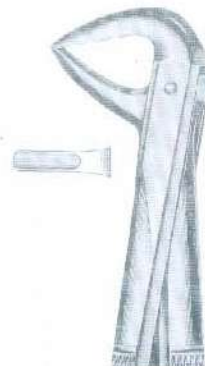

201-0060  
Fig.137  
Lower centrals  
& roots

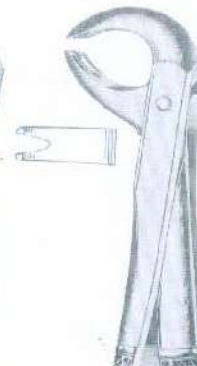

201-0061  
Fig.167  
Universal pincer  
for lower teeth  
molars & premolars

Web: [www.mabsonortho.com](http://www.mabsonortho.com)

Tel: +92 52 3570603  
Fax: +92 52 3570604  
Moh. Islamabad Union Council  
Near Imran Market Ugoki Morre,  
Sialkot-51310 Pakistan.



MABSON ORTHO

**MABSON  
INDUSTRY**

Manufacturer & Exporter of Surgical, Dental & Orthopedic Instruments

**Extracting Forceps  
(english pattern)**

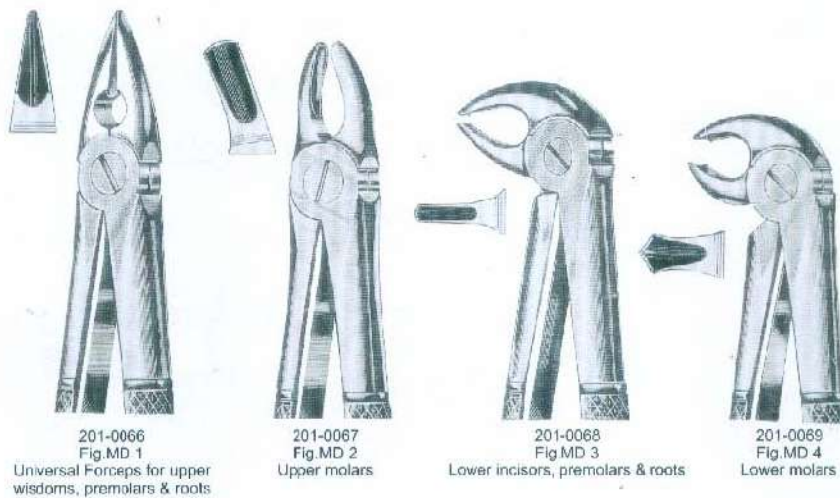
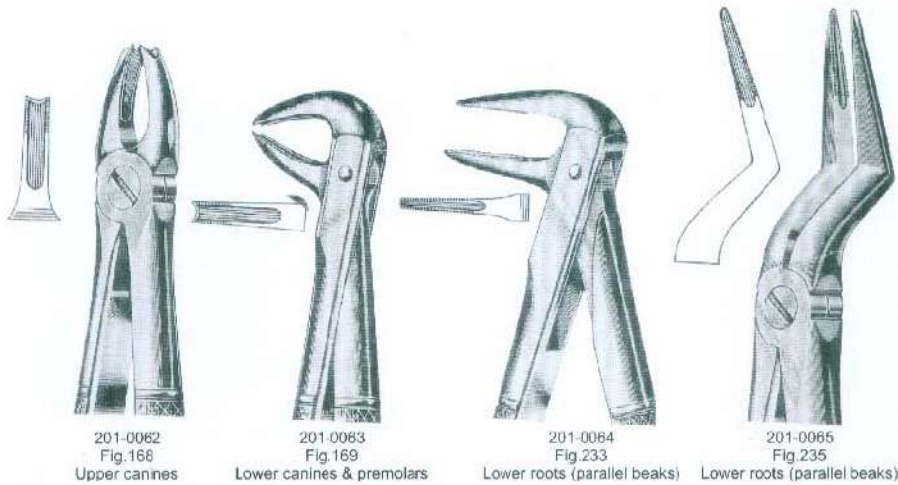

Web: [www.mabsonortho.com](http://www.mabsonortho.com)

Tel: +92 52 3570603  
Fax: +92 52 3570604  
Moh. Islamabad Union Council  
Near Imran Market Ugoki Morre,  
Sialkot-51310 Pakistan.



MABSON ORTHO

# MABSON INDUSTRY

Manufacturer & Exporter of Surgical, Dental & Orthopedic Instruments

## Extracting Forceps (english pattern)

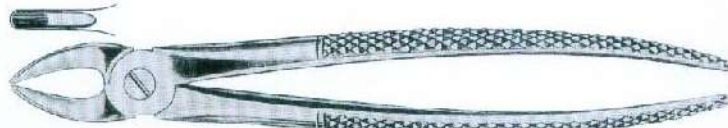

201-0070  
Fig.37

Children's upper incisors & canines

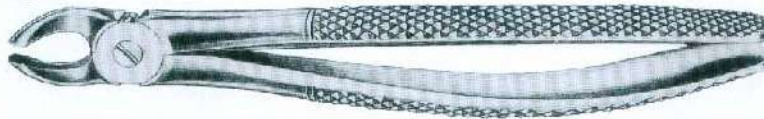

201-0071  
Fig.39

Children's upper molars & universal

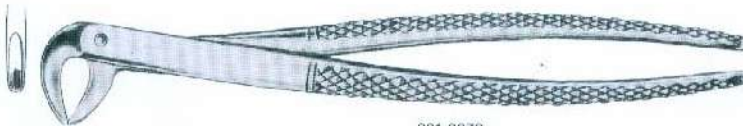

201-0072  
Fig.123

Children's lower teeth universal



201-0073  
Fig.138

Children's upper universal & roots



201-0074  
Fig.157

Children's upper molars universal

Web: [www.mabsonortho.com](http://www.mabsonortho.com)

Tel: +92 52 3570603  
Fax: +92 52 3570604  
Moh. Islamabad Union Council  
Near Imran Market Ugoki Morre,  
Sialkot-51310 Pakistan.



MABSON ORTHO

**MABSON  
INDUSTRY**

Manufacturer & Exporter of Surgical, Dental & Orthopedic Instruments

**Extracting Forceps  
childrens pattern**



201-0075

Fig.158

Children's upper teeth molars universal



201-0076

Fig.159

Children's lower molars universal



201-0077

Fig.160

Children's upper lower universal (hawk's bill)



201-0078

Fig.161

Children's lower & roots



201-0079

Fig.162

Children's upper centrals

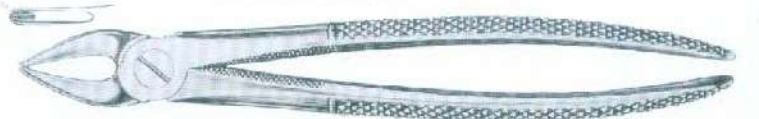

201-0080

Fig.163

Children's upper centrals

Web: [www.mabsonortho.com](http://www.mabsonortho.com)

Tel: +92 52 3570603  
Fax: +92 52 3570604  
Moh. Islamabad Union Council  
Near Imran Market Ugoki Morre,  
Sialkot-51310 Pakistan.





MABSON ORTHO

# MABSON INDUSTRY

Manufacturer & Exporter of Surgical, Dental & Orthopedic Instruments

**Extracting Forceps  
for childrens with spring**



201-0081  
Fig. 3  
Upper molars

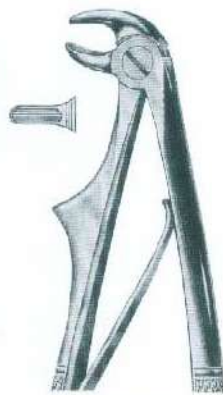

201-0082  
Fig. 5  
Lower incisors

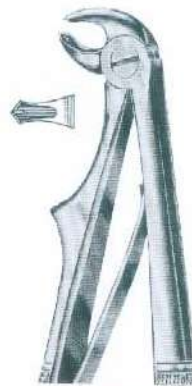

201-0083  
Fig. 8  
Lower molars

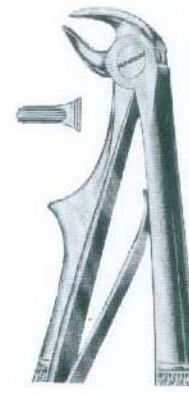

201-0084  
Fig. 7  
Lower roots



201-0085  
Fig. 137  
Upper incisors  
& canines



201-0086  
Fig. 139  
Upper premolars



201-0087  
Fig. 51S  
Upper roots

Web: [www.mabsonortho.com](http://www.mabsonortho.com)

Tel: +92 52 3570603  
Fax: +92 52 3570604  
Moh. Islamabad Union Council  
Near Imran Market Ugoki Morre,  
Sialkot-51310 Pakistan.



MABSON ORTHO

**MABSON  
INDUSTRY**

Manufacturer & Exporter of Surgical, Dental & Orthopedic Instruments

**Extracting Forceps  
root fragment forceps**

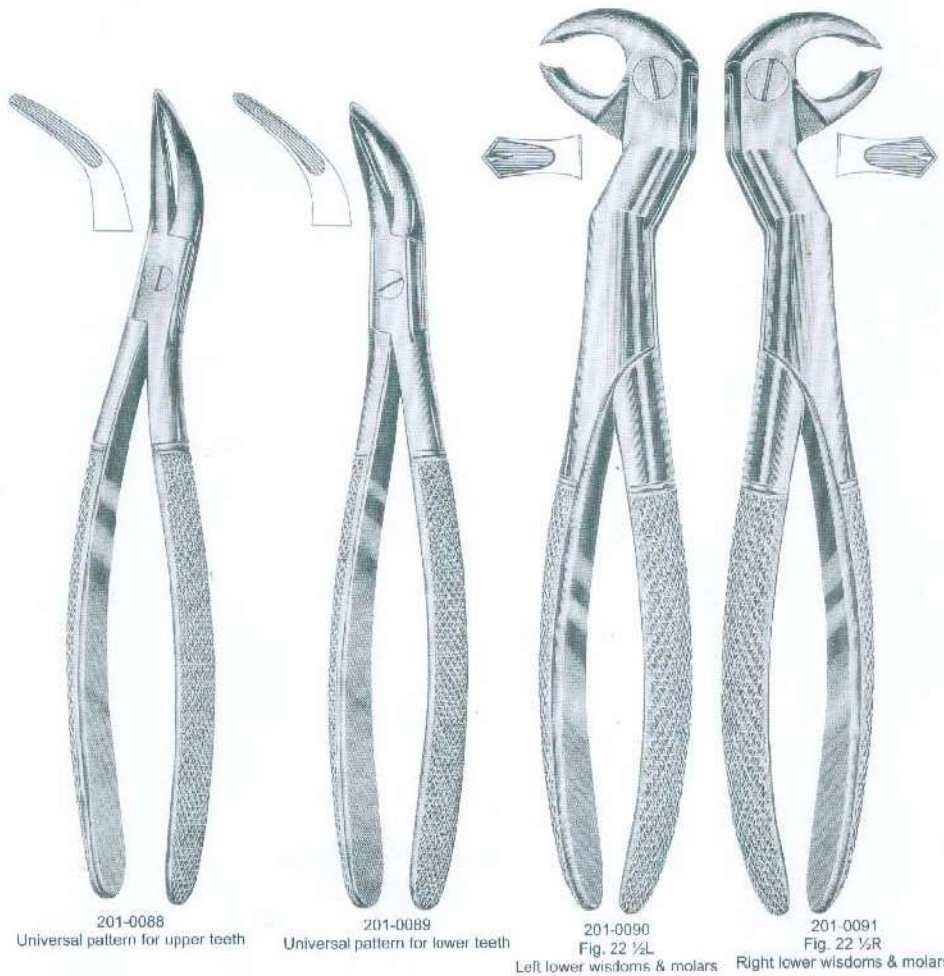

201-0088

Universal pattern for upper teeth

201-0089

Universal pattern for lower teeth

201-0090  
Fig. 22 1/2 L

Left lower wisdoms & molars

201-0091  
Fig. 22 1/2 R

Right lower wisdoms & molars

Web: [www.mabsonortho.com](http://www.mabsonortho.com)

Tel: +92 52 3570603  
Fax: +92 52 3570604  
Moh. Islamabad Union Council  
Near Imran Market Ugoki Morre,  
Sialkot-51310 Pakistan.



MABSON ORTHO

# MABSON INDUSTRY

Manufacturer & Exporter of Surgical, Dental & Orthopedic Instruments

## Extracting Forceps (american pattern)



201-0092  
Fig. 1  
Upper centrals, laterals & cuspids

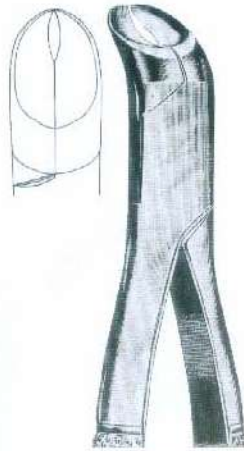

201-0093  
Fig. 5  
Lower third molars

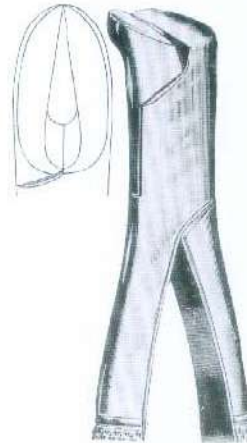

201-0094  
Fig. 6  
Splitting forceps

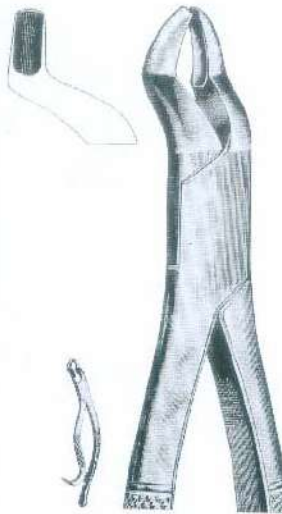

201-0095  
Fig. 10 H  
Upper molars hook-handle



201-0096  
Fig. 10 S  
Upper molars straight-handle



201-0097  
Fig. 15  
Lower molars

Web: [www.mabsonortho.com](http://www.mabsonortho.com)

Tel: +92 52 3570603  
Fax: +92 52 3570604  
Moh. Islamabad Union Council  
Near Imran Market Ugoki Morre,  
Sialkot-51310 Pakistan.



MABSON ORTHO

# MABSON INDUSTRY

Manufacturer & Exporter of Surgical, Dental & Orthopedic Instruments

## Extracting Forceps (american pattern)

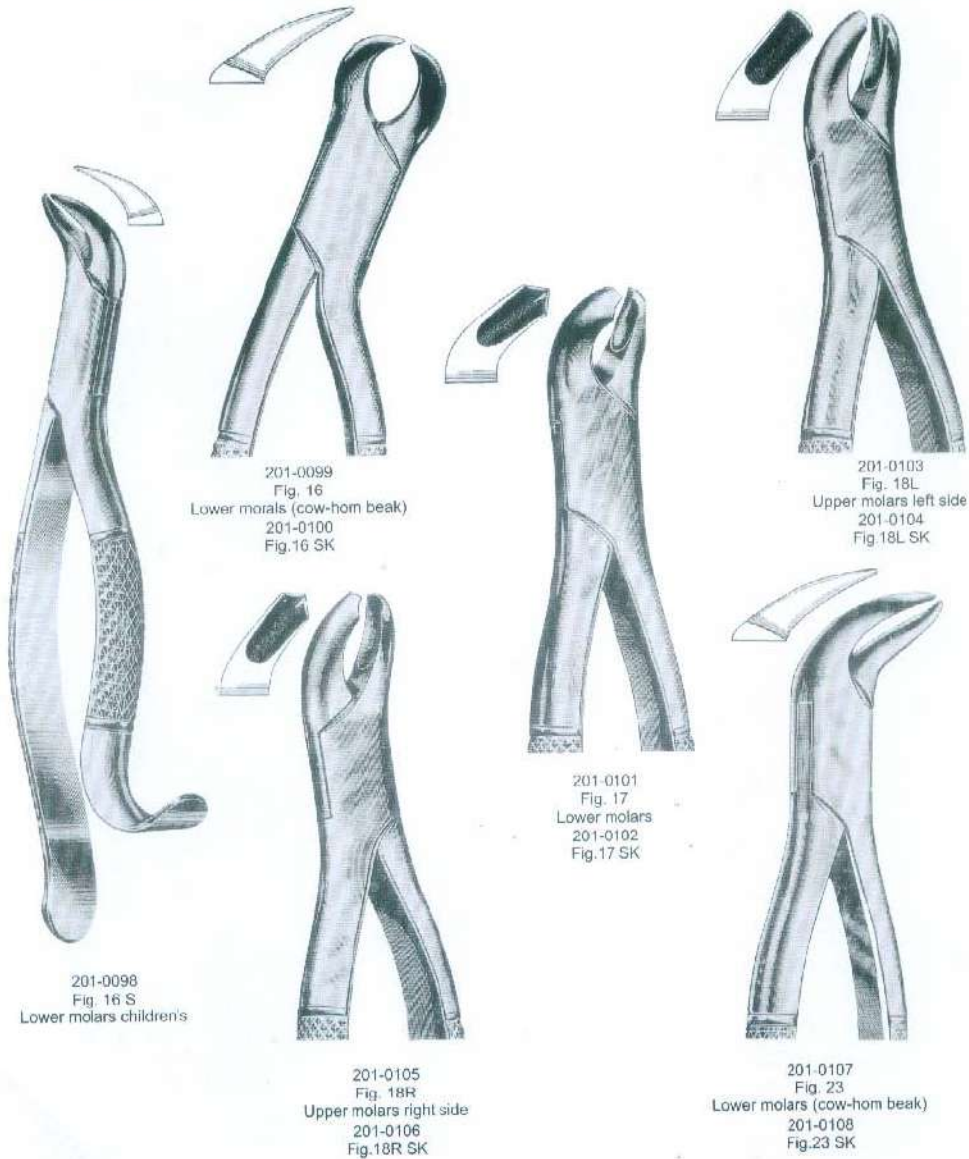

Web: [www.mabsonortho.com](http://www.mabsonortho.com)

Tel: +92 52 3570603  
Fax: +92 52 3570604  
Moh. Islamabad Union Council  
Near Imran Market Ugoki Morre,  
Sialkot-51310 Pakistan.



MABSON ORTHO

# MABSON INDUSTRY

Manufacturer & Exporter of Surgical, Dental & Orthopedic Instruments

**Extracting Forceps  
(american pattern)**

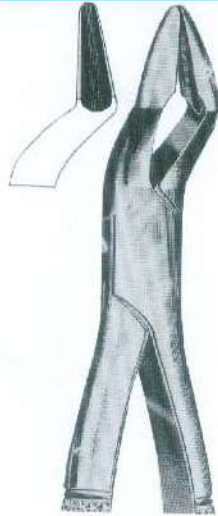

201-0109  
Fig. 32  
Upper molars & pre molars  
strong beak  
201-0110  
Fig. 32 SK

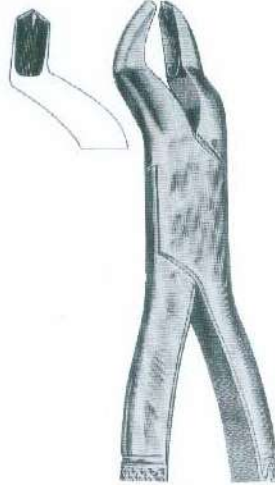

201-0111  
Fig. 53 L  
Upper molars left side  
201-0112  
Fig. 53 L SK

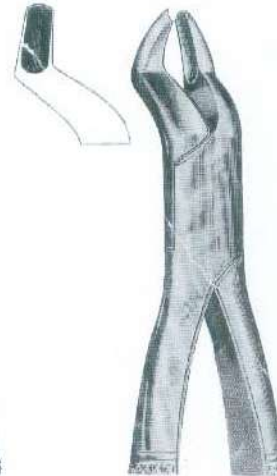

201-0113  
Fig. 53 R  
Upper molars right side  
201-0114  
Fig. 53R SK

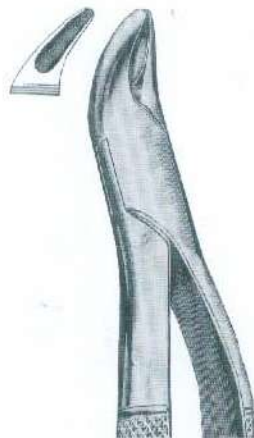

201-0115  
Fig. 62  
Universal forceps  
for upper teeth & roots  
201-0116  
Fig. 62 SK



201-0117  
Fig. 65  
Upper incisors & root  
201-0118  
Fig. 65 SK

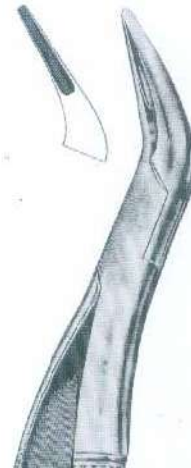

201-0119  
Fig. 69  
Fragments & small roots  
Upper & lower  
201-0120  
Fig. 69 SK

Web: [www.mabsonortho.com](http://www.mabsonortho.com)

Tel: +92 52 3570603  
Fax: +92 52 3570604  
Moh. Islamabad Union Council  
Near Imran Market Ugoki Morre,  
Sialkot-51310 Pakistan.



MABSON ORTHO

# MABSON INDUSTRY

Manufacturer & Exporter of Surgical, Dental & Orthopedic Instruments

## Extracting Forceps (american pattern)

### AMERICAN PATTERN

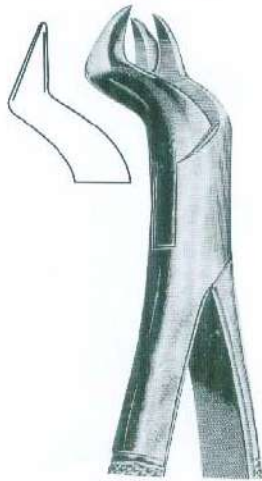

201-0121  
Fig. 88 R  
Right upper molars  
201-0122  
Fig. 88 R SK

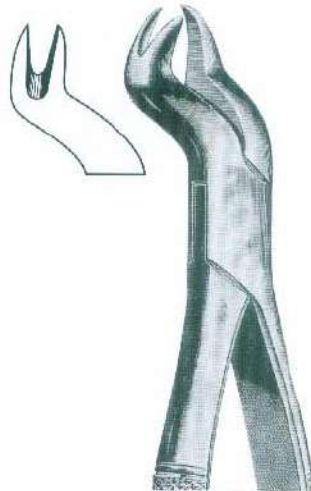

201-0123  
Fig. 88L  
Left upper molars  
201-0124  
Fig. 88L SK

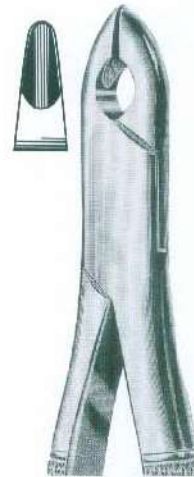

201-0125  
Fig. 99C  
Upper Premolars,  
Molar & incisors  
201-0126  
Fig. 99C SK

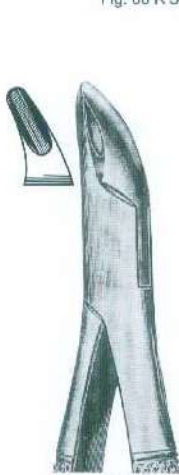

201-0127  
Fig. 101  
Universal forceps  
for premolars  
201-0128  
Fig. 101 SK

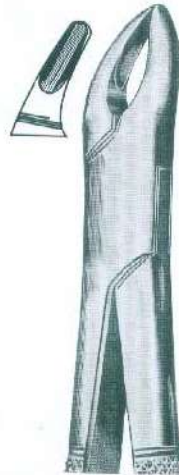

201-0129  
Fig. 150  
Upper premolars,  
incisors & roots  
201-0130  
Fig. 150 SK



201-0131  
Fig. 150A  
Upper premolars incisors & roots  
201-0132  
Fig. 150A SK

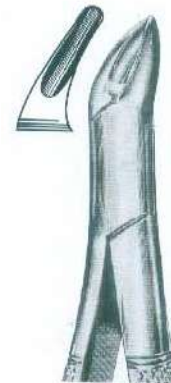

201-0133  
Fig. 150S  
Upper premolars incisors & roots  
for children  
201-0134  
Fig. 150 SK

Web: [www.mabsonortho.com](http://www.mabsonortho.com)

Tel: +92 52 3570603  
Fax: +92 52 3570604  
Moh. Islamabad Union Council  
Near Imran Market Ugoki Morre,  
Sialkot-51310 Pakistan.



MABSON ORTHO

# MABSON INDUSTRY

Manufacturer & Exporter of Surgical, Dental & Orthopedic Instruments

## Extracting Forceps (american pattern)

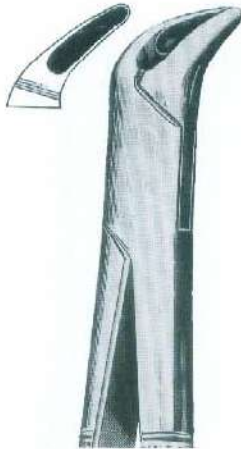

201-0135  
Fig. 151  
Lower premolars, incisors & roots  
201-0136  
Fig. 151 SK

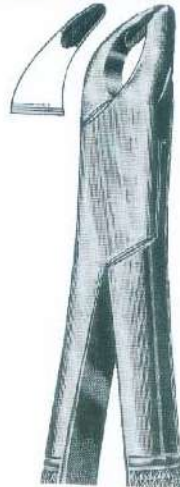

201-0137  
Fig. 151A  
Lower premolars, incisors & roots  
201-0138  
Fig. 151A SK

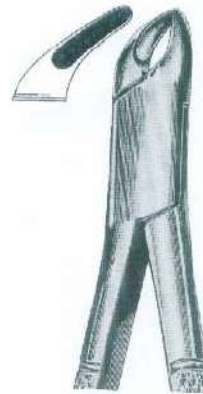

201-0139  
Fig. 151S  
Lower premolars, incisors & roots  
for children's  
201-0140  
Fig. 151 SK

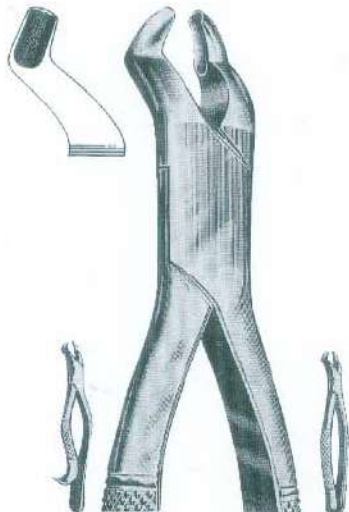

201-0141  
Fig. 210H  
Upper wisdoms with  
hook handle  
201-0142  
Fig. 210H SK

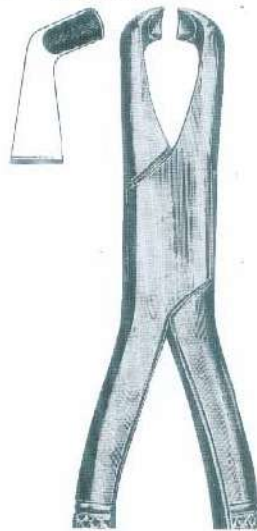

201-0143  
Fig. 210S  
Upper wisdoms with  
straight handle  
201-0144  
Fig. 210 SK

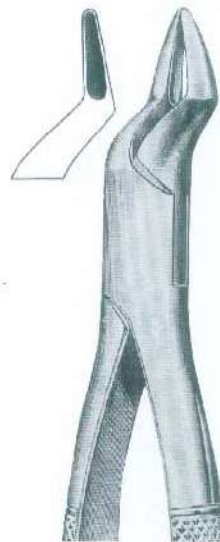

201-0145  
Fig. 222  
Lower wisdoms  
201-0146  
Fig. 222 SK

201-0147  
Fig. 206  
Upper roots, premolars & incisors  
20-0148  
Fig. 286 SK

Web: [www.mabsonortho.com](http://www.mabsonortho.com)

Tel: +92 52 3570603  
Fax: +92 52 3570604  
Moh. Islamabad Union Council  
Near Imran Market Ugoki Morre,  
Sialkot-51310 Pakistan.



MABSON ORTHO

# MABSON INDUSTRY

Manufacturer & Exporter of Surgical, Dental & Orthopedic Instruments

## Extracting Forceps Extracting Tweezer

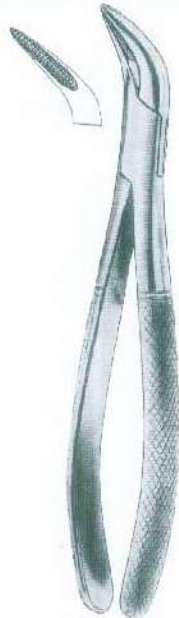

201-0149  
Fig. 1  
Lower roots



201-0150  
Fig. 2  
Upper roots



201-0151  
Fig. 44  
201-0152  
Fig. 44 SK



201-0153  
Albrecht 16cm



201-0154  
Albrecht 16cm

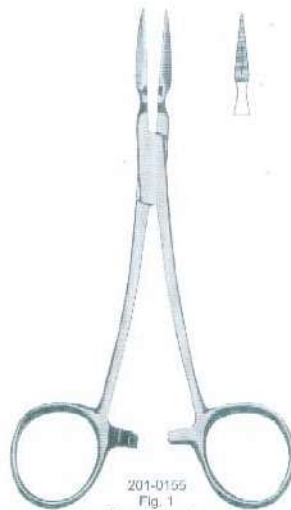

201-0155  
Fig. 1  
Root fragments



201-0156  
Fig. 2  
Root fragments

Web: [www.mabsonortho.com](http://www.mabsonortho.com)

Tel: +92 52 3570603  
Fax: +92 52 3570604  
Moh. Islamabad Union Council  
Near Imran Market Ugoki Morre,  
Sialkot-51310 Pakistan.





MABSON ORTHO

# MABSON INDUSTRY

Manufacturer & Exporter of Surgical, Dental & Orthopedic Instruments

Plier for orthodontics  
& prosthetics



202-0001  
Waldsachs  
15cm



202-0002  
Universal  
16cm



202-0003  
Nance  
13.5



202-0004  
Aderer  
14.5cm



202-0005  
Model marburg  
Serrated jaws  
14cm



202-0006  
Model marburg  
Smooth jaws  
14cm



202-0007  
Model marburg  
Carbid inserts jaws  
14cm



202-0008  
Goslee  
One Serrated jaws  
14cm

Web: [www.mabsonortho.com](http://www.mabsonortho.com)

Tel: +92 52 3570603  
Fax: +92 52 3570604  
Moh. Islamabad Union Council  
Near Imran Market Ugoki Morre,  
Sialkot-51310 Pakistan.



MABSON ORTHO

# MABSON INDUSTRY

Manufacturer & Exporter of Surgical, Dental & Orthopedic Instruments

Plier for orthodontics  
& prosthetics



202-0009  
Flat Pliers  
14cm



202-0010  
14cm



202-0011  
14cm



202-0012  
14.5cm



202-0013  
14.5cm



202-0014  
14cm



202-0015  
14cm



202-0016  
14cm



202-0017  
Serrated jaws  
12cm

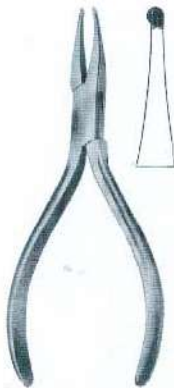

202-0018  
How  
14.5cm



202-0019  
How-angled  
14.5cm

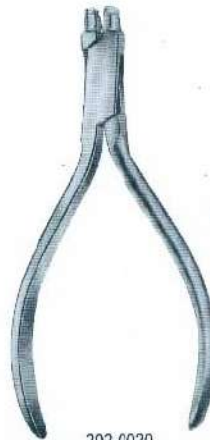

202-0020  
Arrow clasp forming  
12cm



202-0021  
Arrow clasp forming  
12cm



202-0022  
Arrow clasp bending  
12cm

Web: [www.mabsonortho.com](http://www.mabsonortho.com)

Tel: +92 52 3570603  
Fax: +92 52 3570604  
Moh. Islamabad Union Council  
Near Imran Market Ugoki Morre,  
Sialkot-51310 Pakistan.



MABSON ORTHO

# MABSON INDUSTRY

Manufacturer & Exporter of Surgical, Dental & Orthopedic Instruments

Plier for orthodontics  
& prosthetics



202-0023  
Peeso  
13.5cm

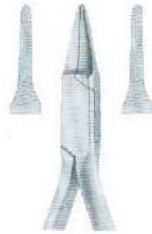

202-0024  
Peeso  
13.5cm



202-0025  
14cm



202-0026  
Langenbeck  
14cm



202-0027  
Jarabak  
14cm



202-0028  
Bending Plier  
13cm



202-0029  
Angle  
12.5cm



202-0030  
Andresen  
13cm



202-0031  
Bending Plier  
13.5cm

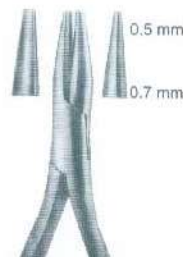

202-0032  
Schwarz  
13.5cm

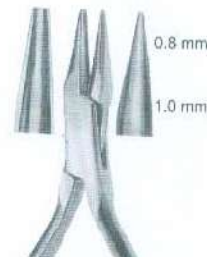

202-0033  
Fischer  
13cm

Web: [www.mabsonortho.com](http://www.mabsonortho.com)

Tel: +92 52 3570603  
Fax: +92 52 3570604  
Moh. Islamabad Union Council  
Near Imran Market Ugoki Morre,  
Sialkot-51310 Pakistan.



MABSON ORTHO

# MABSON INDUSTRY

Manufacturer & Exporter of Surgical, Dental & Orthopedic Instruments

Plier for orthodontics  
& prosthetics



202-0034  
Aderer  
12cm



202-0035  
Aderer-Heavy  
12cm

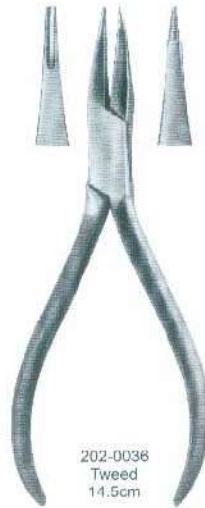

202-0036  
Tweed  
14.5cm



202-0037  
O'Brien  
13.5cm



202-0038  
Wire bending pliers  
12.5cm



202-0039  
Adams  
12.5cm



202-0041  
Young  
14cm



202-0039  
Adams  
12.5cm



202-0040  
Frevert  
12.5cm



202-0042  
Clasp forming  
14cm

Web: [www.mabsonortho.com](http://www.mabsonortho.com)

Tel: +92 52 3570603  
Fax: +92 52 3570604  
Moh. Islamabad Union Council  
Near Imran Market Ugoki Morre,  
Sialkot-51310 Pakistan.



MABSON ORTHO

# MABSON INDUSTRY

Manufacturer & Exporter of Surgical, Dental & Orthopedic Instruments

## Plier for Orthodontics & Prosthetics



202-0043  
Hard Wire Cutter  
5 1/2" (14 cm)



202-0044  
Arch Forming Plier  
5 1/2" (14 cm)



202-0045  
Medium Size Bending Pliers  
5 1/2" (14 cm)



202-0046  
Aderer Pliers  
5 1/2" (14 cm)



202-0047  
Wire Bending Plier  
5 1/2" (14 cm)



202-0048  
Round & Concave Plier  
5 1/2" (14 cm)

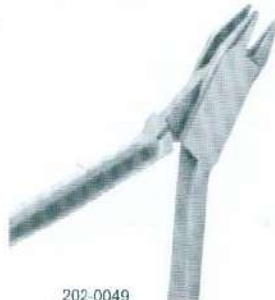

202-0049  
Aderer Pliers  
with narrow standing points,  
for bending wires up to  $\phi$  0.5mm,  
disinfectable, sterilizable  
4 3/4" (12cm)



202-0050  
Aderer Pliers  
for bending wires up to  $\phi$  0.9mm,  
disinfectable, sterilizable  
4 1/4" (12cm)



202-0051  
Bending plier for lingual cleat  
5 1/2" (14cm)

Web: [www.mabsonortho.com](http://www.mabsonortho.com)

Tel: +92 52 3570603  
Fax: +92 52 3570604  
Moh. Islamabad Union Council  
Near Imran Market Ugoki Morre,  
Sialkot-51310 Pakistan.



MABSON ORTHO

# MABSON INDUSTRY

Manufacturer & Exporter of Surgical, Dental & Orthopedic Instruments

**Plier for Orthodontics  
& Prosthetics**

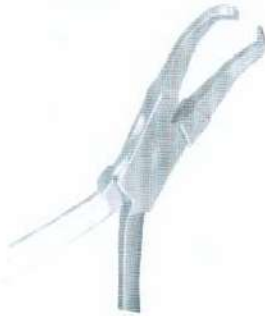

202-0052  
Bracket Removing Pliers  
5 1/2" (14 cm)



202-0053  
Bracket Removing Pliers  
5 1/2" (14 cm)



202-0054  
Bracket Removing Pliers  
5 1/2" (14 cm)



202-0055  
Bracket Removing Pliers  
5 1/2" (14cm)



202-0056  
Bracket Removing Pliers  
5 1/2" (14cm)



202-0057  
Flat Pliers  
5 1/2" (14 cm)



202-0058  
Nance Closing Loop Pliers  
5 1/2" (14 cm)



202-0059  
Angle Bending Pliers  
5 1/2" (14 cm)



202-0060  
Crown Crimping Pliers  
5 1/2" (14 cm)

Web: [www.mabsonortho.com](http://www.mabsonortho.com)

Tel: +92 52 3570603  
Fax: +92 52 3570604  
Moh. Islamabad Union Council  
Near Imran Market Ugoki Morre,  
Sialkot-51310 Pakistan.



MABSON ORTHO

# MABSON INDUSTRY

Manufacturer & Exporter of Surgical, Dental & Orthopedic Instruments

## Plier for Orthodontics & Prosthetics

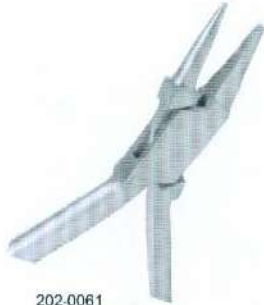

202-0061  
Round & Flat Plier  
5 1/2" (14 cm)

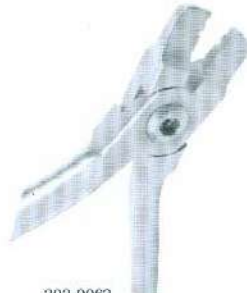

202-0062  
Tweed Angle Arch Bonding  
5 1/2" (14 cm)



202-0063  
Band Removing Pliers  
5 1/2" (14 cm)



202-0064  
Johnson Contouring Pliers  
5 1/2" (14 cm)



202-0065  
Round Nose Pliers  
5 1/2" (14 cm)



202-0066  
Tweed Angle Arch Bonding  
5 1/2" (14 cm)



202-0067  
De La Rosa Pliers  
5 1/2" (14 cm)



202-0068  
Arch Forming Plier  
5 1/2" (14 cm)



202-0069  
Tweed Angle Arch Bonding  
5 1/2" (14 cm)

Web: [www.mabsonortho.com](http://www.mabsonortho.com)

Tel: +92 52 3570603  
Fax: +92 52 3570604  
Moh. Islamabad Union Council  
Near Imran Market Ugoki Morre,  
Sialkot-51310 Pakistan.



MABSON ORTHO

# MABSON INDUSTRY

Manufacturer & Exporter of Surgical, Dental & Orthopedic Instruments

## Plier for Orthodontics & Prosthetics



202-0070  
Flat Nose Plier  
5 1/2" (14 cm)



202-0071  
How Pliers  
5 1/2" (14 cm)



202-0072  
Gordon - Contouring  
5 1/2" (14 cm)



202-0073  
Adams Pliers  
5 1/2" (14 cm)



202-0074  
Adams Pliers  
5 1/2" (14 cm)



202-0075  
Tweed Pliers  
5 1/2" (14 cm)

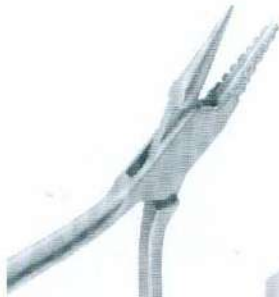

202-0076  
Bending Pliers  
mediumfine, with graduation,  
for wires up to 1.0mm  
5 1/2" (14cm)

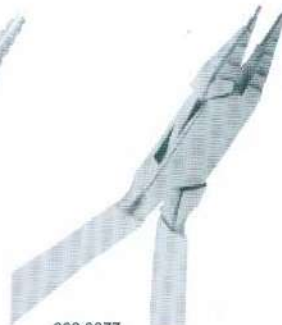

202-0077  
Special pliers  
max .022" x .028"  
5 1/2" (14cm)

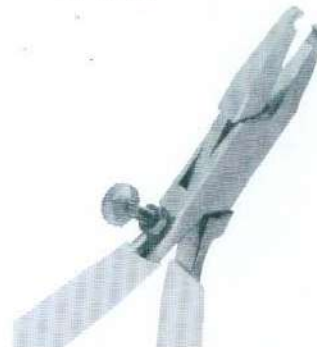

202-0078  
Pliers for operating the Mobil-Stop  
5 1/2" (14cm)

Web: [www.mabsonortho.com](http://www.mabsonortho.com)

Tel: +92 52 3570603  
Fax: +92 52 3570604  
Moh. Islamabad Union Council  
Near Imran Market Ugoki Morre,  
Sialkot-51310 Pakistan.





MABSON ORTHO

# MABSON INDUSTRY

Manufacturer & Exporter of Surgical, Dental & Orthopedic Instruments

**Plier for Orthodontics  
& Prosthetics**



202-0079  
Light wire pliers for wires  
up to  $\varnothing$  0.60mm  
with cutter Begg  
4  $\frac{3}{4}$ " (12cm)



202-0080  
Weingart Universal Pliers  
5  $\frac{1}{2}$ " (14 cm)



202-0081  
Weingart ultra lightwire Pliers  
5  $\frac{1}{2}$ " (14 cm)



202-0082  
Weingart Universal lightwire Pliers  
max. .022" x .028  
5  $\frac{1}{2}$ " (14cm)

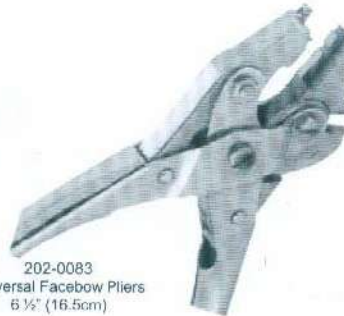

202-0083  
Universal Facebow Pliers  
6  $\frac{1}{2}$ " (16.5cm)

Web: [www.mabsonortho.com](http://www.mabsonortho.com)

Tel: +92 52 3570603  
Fax: +92 52 3570604  
Moh. Islamabad Union Council  
Near Imran Market Ugoki Morre,  
Sialkot-51310 Pakistan.



MABSON ORTHO

# MABSON INDUSTRY

Manufacturer & Exporter of Surgical, Dental & Orthopedic Instruments

## Carbide Inserted Pliers



202-0084  
Distal Cutter Light Weight  
5 1/2" (14 cm)



202-0085  
Distal Cutter medium  
5 1/2" (14 cm)



202-0086  
Ligature Pin Cutter  
5 1/2" (14 cm)



201-0087  
Hard Wire Cutter  
5 1/2" (14 cm)



202-0088  
Hard Wire Cutter  
5 1/2" (14 cm)



202-0089  
Bracket Removing Pliers  
5 1/2" (14 cm)



202-0090  
Arch torquing and bending pliers  
for wires up to  $\phi$  0.60mm  
allow to user a pair  
4 1/4" (12cm)



Web: [www.mabsonortho.com](http://www.mabsonortho.com)

Tel: +92 52 3570603  
Fax: +92 52 3570604  
Moh. Islamabad Union Council  
Near Imran Market Ugoki Morre,  
Sialkot-51310 Pakistan.



MABSON ORTHO

# MABSON INDUSTRY

Manufacturer & Exporter of Surgical, Dental & Orthopedic Instruments

## Bone Rongeurs



203-0001  
BEYER  
150mm (6")  
5mm bite



203-0002  
JANSEN-MIDDLETON  
SEPTUM FORCEPS  
200mm (8") Spoon shaped  
4mm bite



203-0003  
CAIRNS  
140mm (5 1/2")  
4mm bite



203-0004  
CAIRNS  
140mm (5.1/2")  
4mm bite



203-0005  
LUER  
155mm (6")



203-0006  
RUSKIN  
190mm (7.1/2")  
6mm bite

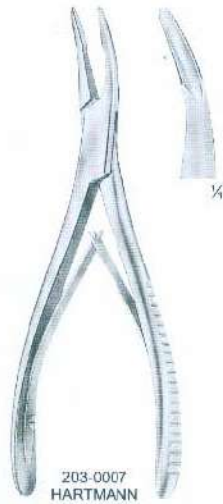

203-0007  
HARTMANN  
180mm (7")



203-0008  
MEAD  
165mm (6.1/2")



203-0009  
JANSEN  
160mm (6")

Web: [www.mabsonortho.com](http://www.mabsonortho.com)

Tel: +92 52 3570603  
Fax: +92 52 3570604  
Moh. Islamabad Union Council  
Near Imran Market Ugoki Morre,  
Sialkot-51310 Pakistan.



MABSON ORTHO

# MABSON INDUSTRY

Manufacturer & Exporter of Surgical, Dental & Orthopedic Instruments

## Bone Rongeurs

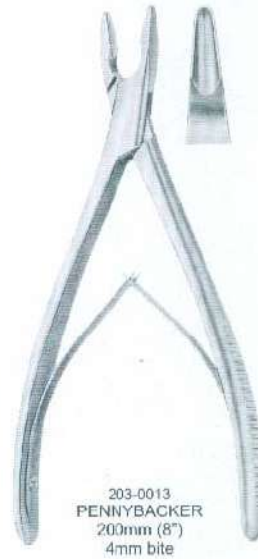
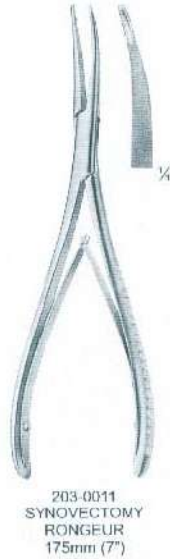

Web: [www.mabsonortho.com](http://www.mabsonortho.com)

Tel: +92 52 3570603  
Fax: +92 52 3570604  
Moh. Islamabad Union Council  
Near Imran Market Ugoki Morre,  
Sialkot-51310 Pakistan.



MABSON ORTHO

# MABSON INDUSTRY

Manufacturer & Exporter of Surgical, Dental & Orthopedic Instruments

## Bone Rongeurs



203-0019  
LUER-JANSEN  
170mm (6.3/4")  
4mm bite

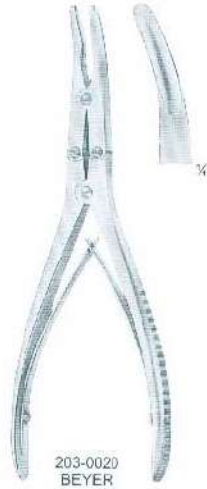

203-0020  
BEYER  
180mm (7")  
4mm bite



203-0021  
BEYER  
200mm (8")  
4mm bite

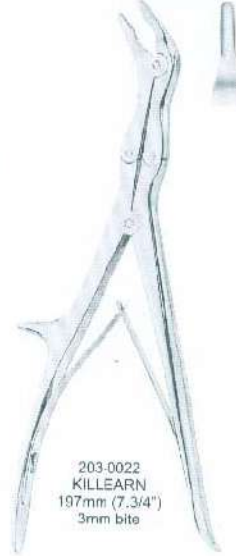

203-0022  
KILLEARN  
197mm (7.3/4")  
3mm bite



203-0023  
ZALFAL-JANSEN  
240mm (9.1/2")  
4mm bite



203-0024  
ECHLIN  
240mm (9.1/2")  
4mm bite

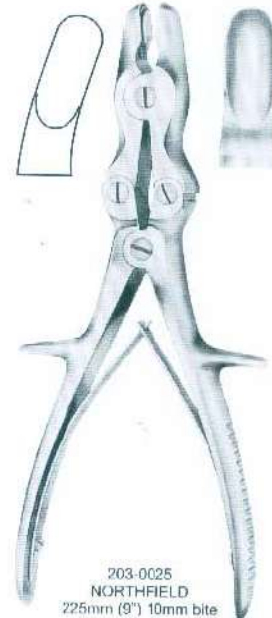

203-0025  
NORTHFIELD  
225mm (9") 10mm bite

Web: [www.mabsonortho.com](http://www.mabsonortho.com)

Tel: +92 52 3570603  
Fax: +92 52 3570604  
Moh. Islamabad Union Council  
Near Imran Market Ugoki Morre,  
Sialkot-51310 Pakistan.



MABSON ORTHO

# MABSON INDUSTRY

Manufacturer & Exporter of Surgical, Dental & Orthopedic Instruments

## Bone Rongeurs



203-0026  
SARGENT (VAN HAVRE)  
220mm (8.3/4")  
10mm bite

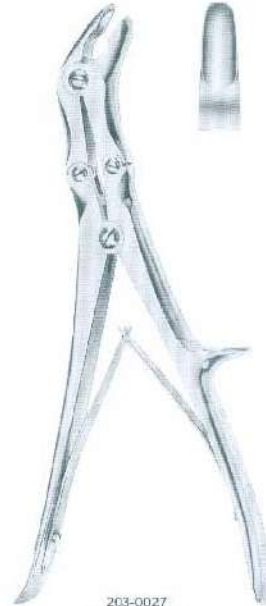

203-0027  
OLIVECRONA  
230mm (9")  
6mm bite

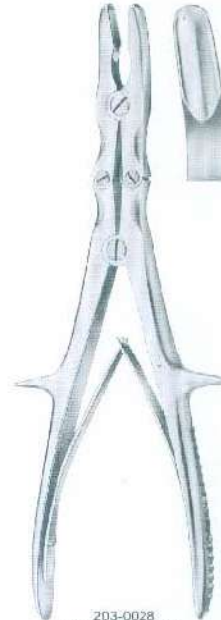

203-0028  
STILLE-RUSKIN  
240mm (9 1/2")

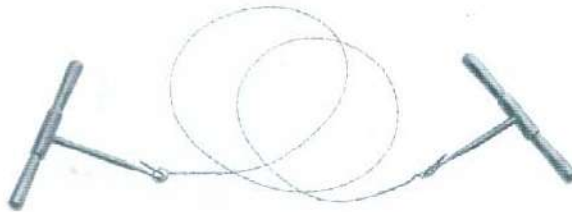

203-0029  
GIGLI SAW WITH HANDLE  
500mm (20")

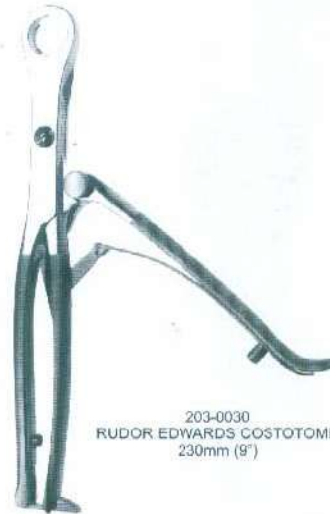

203-0030  
RUDOR EDWARDS COSTOTOME  
230mm (9")

Web: [www.mabsonortho.com](http://www.mabsonortho.com)

Tel: +92 52 3570603  
Fax: +92 52 3570604  
Moh. Islamabad Union Council  
Near Imran Market Ugoki Morre,  
Sialkot-51310 Pakistan.



MABSON ORTHO

# MABSON INDUSTRY

Manufacturer & Exporter of Surgical, Dental & Orthopedic Instruments

## Root Elevators

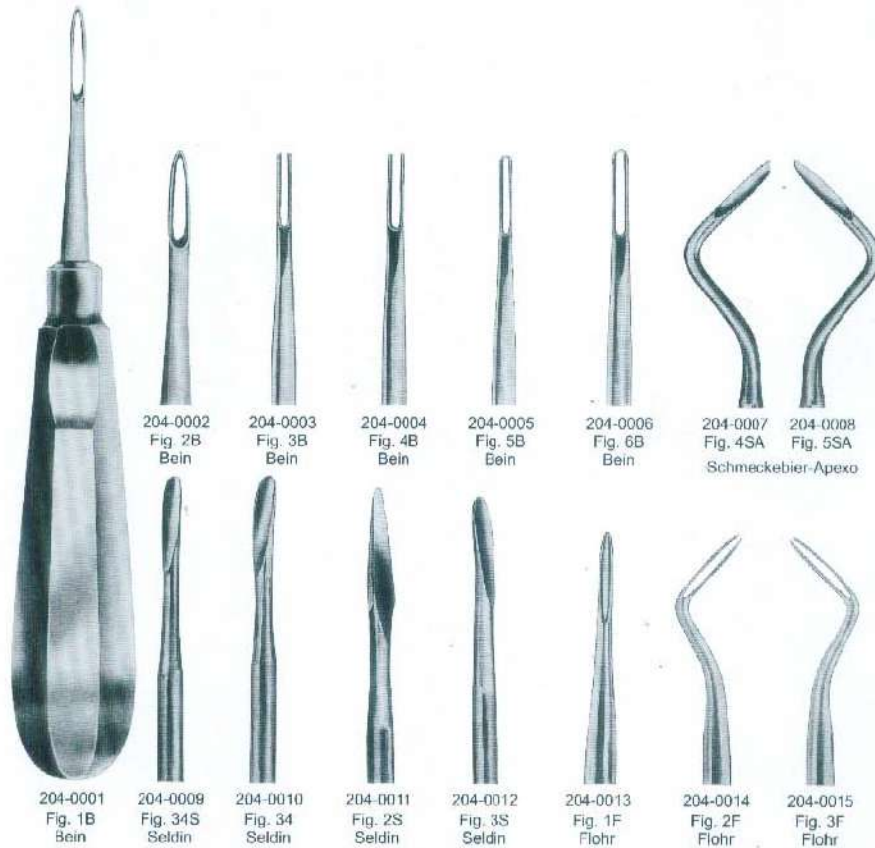

Web: [www.mabsonortho.com](http://www.mabsonortho.com)

Tel: +92 52 3570603  
Fax: +92 52 3570604  
Moh. Islamabad Union Council  
Near Imran Market Ugoki Morre,  
Sialkot-51310 Pakistan.



MABSON ORTHO

# MABSON INDUSTRY

Manufacturer & Exporter of Surgical, Dental & Orthopedic Instruments

## Root Elevators

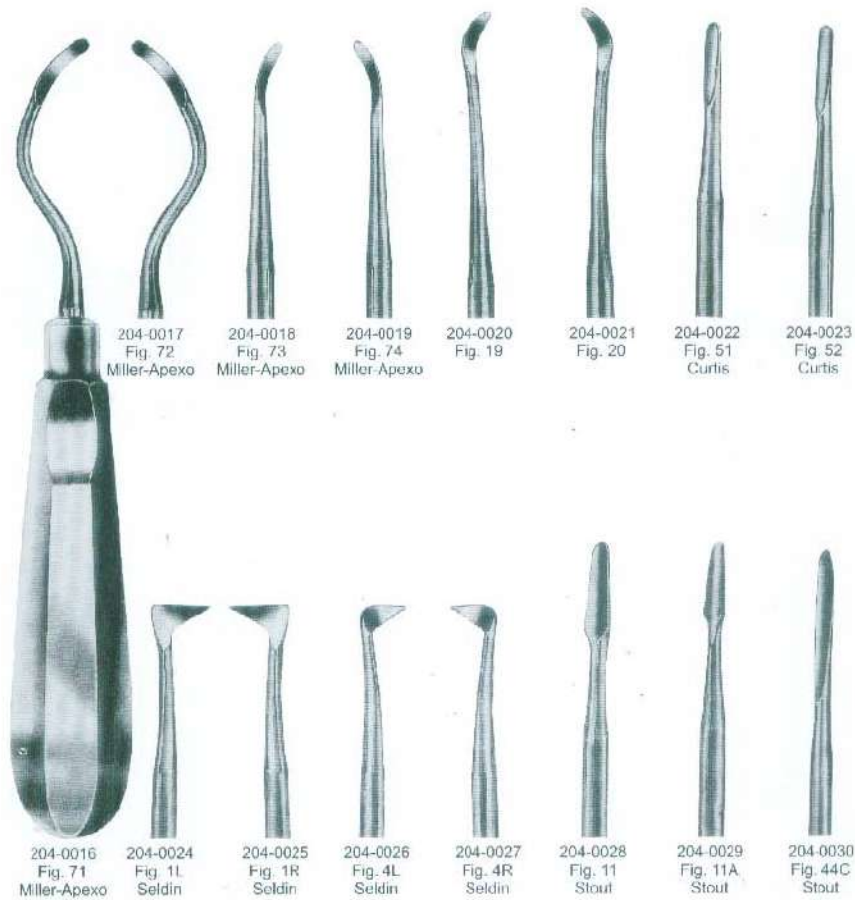

Web: [www.mabsonortho.com](http://www.mabsonortho.com)

Tel: +92 52 3570603  
Fax: +92 52 3570604  
Moh. Islamabad Union Council  
Near Imran Market Ugoki Morre,  
Sialkot-51310 Pakistan.





MABSON ORTHO

**MABSON  
INDUSTRY**

Manufacturer & Exporter of Surgical, Dental & Orthopedic Instruments

## Root Elevators



204-0031  
Fig. A  
Cogswell



204-0032  
Fig. B  
Cogswell



204-0033  
Fig. 301  
Apexo



204-0034  
Fig. 302  
Apexo



204-0035  
Fig. 303  
Apexo



204-0036  
Fig. 301W  
Seldin



204-0037  
Fig. 304W  
Seldin



204-0038  
Fig. 1H  
Heidbrink



204-0039  
Fig. 2H  
Heidbrink



204-0040  
Fig. 40H  
Heidbrink



204-0041  
Fig. 41H  
Heidbrink



204-0042  
Fig. 46



204-0043  
Fig. 46R

Web: [www.mabsonortho.com](http://www.mabsonortho.com)

Tel: +92 52 3570603  
Fax: +92 52 3570604  
Moh. Islamabad Union Council  
Near Imran Market Ugoki Morre,  
Sialkot-51310 Pakistan.



MABSON ORTHO

# MABSON INDUSTRY

Manufacturer & Exporter of Surgical, Dental & Orthopedic Instruments

## Root Elevators

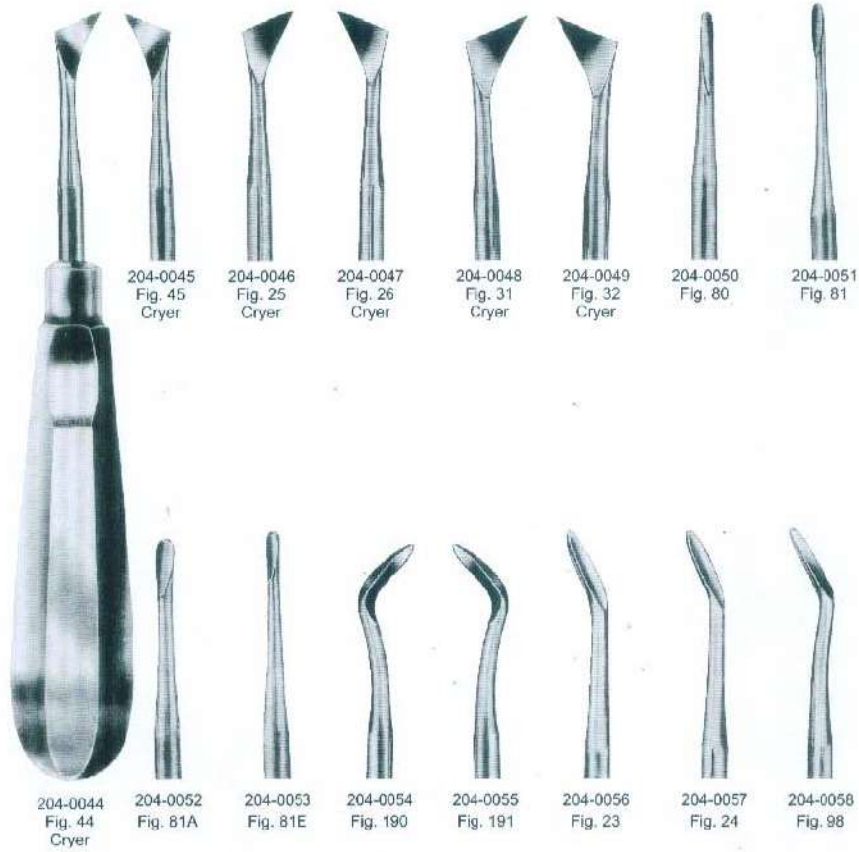

Web: [www.mabsonortho.com](http://www.mabsonortho.com)

Tel: +92 52 3570603  
Fax: +92 52 3570604  
Moh. Islamabad Union Council  
Near Imran Market Ugoki Morre,  
Sialkot-51310 Pakistan.



MABSON ORTHO

# MABSON INDUSTRY

Manufacturer & Exporter of Surgical, Dental & Orthopedic Instruments

## Root Elevators

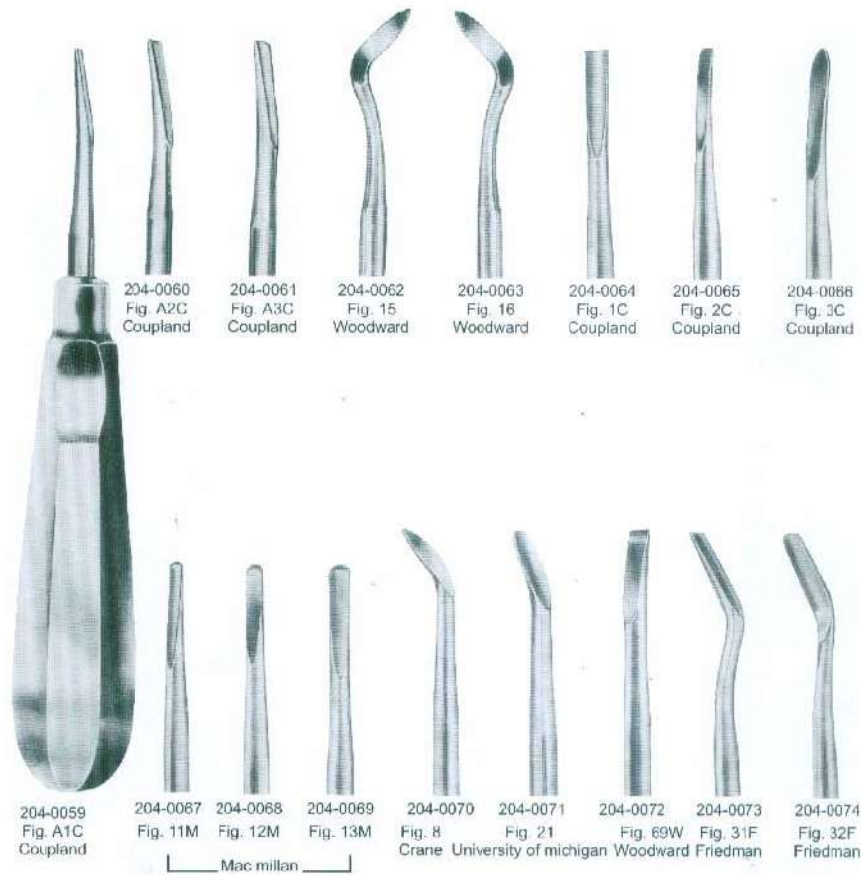

Web: [www.mabsonortho.com](http://www.mabsonortho.com)

Tel: +92 52 3570603  
Fax: +92 52 3570604  
Moh. Islamabad Union Council  
Near Imran Market Ugoki Morre,  
Sialkot-51310 Pakistan.



MABSON ORTHO

# MABSON INDUSTRY

Manufacturer & Exporter of Surgical, Dental & Orthopedic Instruments

## Root Elevators



204-0075  
Fig. 1  
Bein



204-0076  
Fig. 2  
Bein



204-0077  
Fig. 3  
Bein



204-0078  
Fig. 4  
Bein



204-0079  
Fig. 5  
Bein



204-0080  
Fig. 6  
Bein



204-0081  
Fig. 1



204-0082  
Fig. 2



204-0083  
Fig. 2  
Flohr



204-0084  
Fig. 3  
Flohr



204-0085  
Fig. 3  
Cryer



204-0086  
Fig. 8  
Cryer

Web: [www.mabsonortho.com](http://www.mabsonortho.com)

Tel: +92 52 3570603  
Fax: +92 52 3570604  
Moh. Islamabad Union Council  
Near Imran Market Ugoki Morre,  
Sialkot-51310 Pakistan.



MABSON ORTHO

# MABSON INDUSTRY

Manufacturer & Exporter of Surgical, Dental & Orthopedic Instruments

## Root Elevators

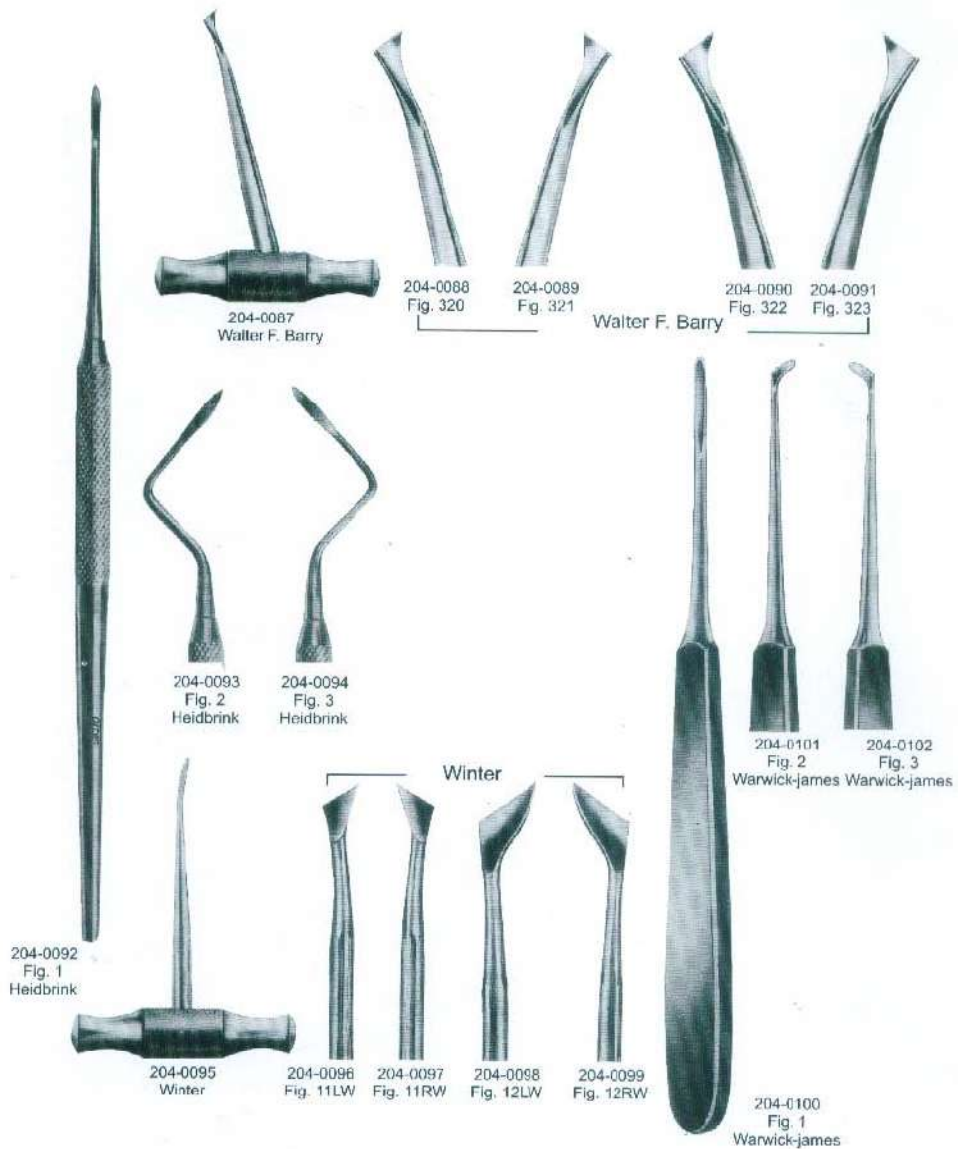

Web: [www.mabsonortho.com](http://www.mabsonortho.com)

Tel: +92 52 3570603  
Fax: +92 52 3570604  
Moh. Islamabad Union Council  
Near Imran Market Ugoki Morre,  
Sialkot-51310 Pakistan.



MABSON ORTHO

# MABSON INDUSTRY

Manufacturer & Exporter of Surgical, Dental & Orthopedic Instruments

**Orthodontics  
Instruments**

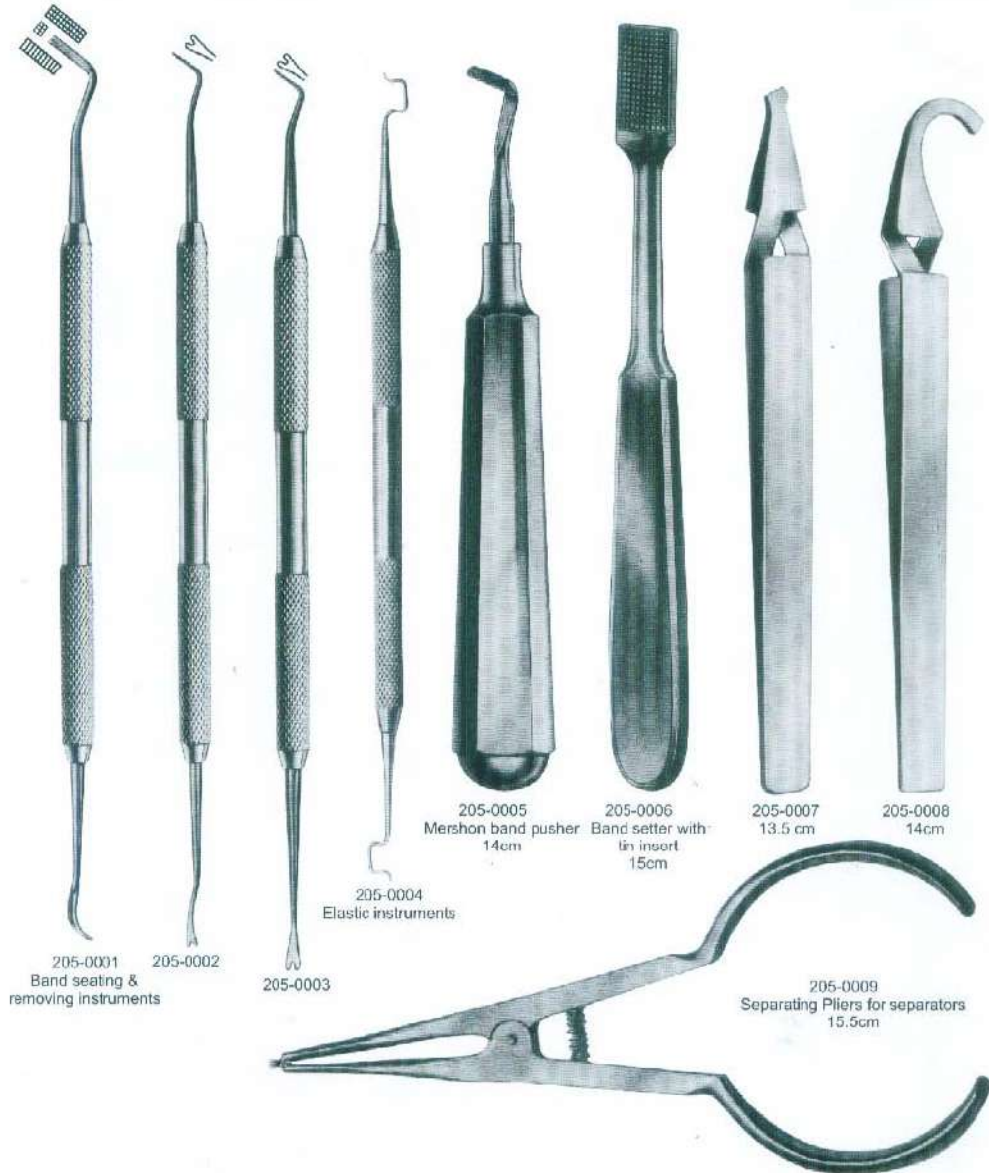

Web: [www.mabsonortho.com](http://www.mabsonortho.com)

Tel: +92 52 3570603  
Fax: +92 52 3570604  
Moh. Islamabad Union Council  
Near Imran Market Ugoki Morre,  
Sialkot-51310 Pakistan.



MABSON ORTHO

# MABSON INDUSTRY

Manufacturer & Exporter of Surgical, Dental & Orthopedic Instruments

## Orthodontics Instruments



205-0010  
Mathieu pliers  
14cm



205-0011  
Elastic ligature placing pliers  
14cm

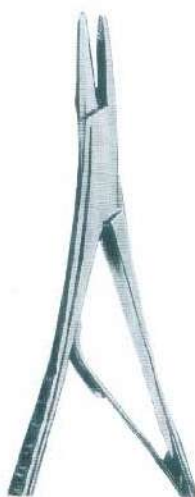

205-0012  
Mathieu ligating pliers  
14cm



205-0013  
Mathieu pliers  
with finger ring  
14cm



205-0014  
Straight 5"  
Mosquito Forceps  
205-0015  
Curved 5"



205-0016  
Ligature tying piler



205-0017  
Bracket positioning gauge



Hook



205-0023  
Straight 5"  
Mosquito Forceps  
205-0024  
Curved 5"



205-0018  
Bracket placing  
tweezer



205-0019  
Bracket placing  
tweezer



205-0020  
Clamping Tweezer



205-0021  
Bracket holding tweezers



205-0022  
Band seating  
Instruments  
nylon

Web: [www.mabsonortho.com](http://www.mabsonortho.com)

Tel: +92 52 3570603  
Fax: +92 52 3570604  
Moh. Islamabad Union Council  
Near Imran Market Ugoki Morre,  
Sialkot-51310 Pakistan.



MABSON ORTHO

# MABSON INDUSTRY

Manufacturer & Exporter of Surgical, Dental & Orthopedic Instruments

## Gum Scissors

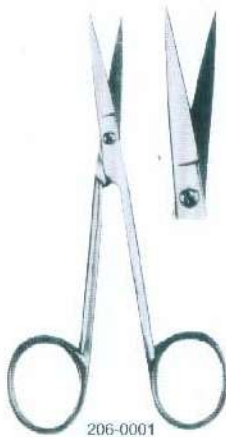

206-0001  
Fig. 1  
12cm Straight



206-0002  
Fig. 2  
12cm curved



206-0003  
Fig. 1  
13cm  
Goldman-Fox  
Saw edge  
Straight



206-0004  
Fig. 2  
13cm  
Goldman-Fox  
Saw edge  
curved



206-0005  
Fig. 1  
11.5cm  
Iris Straight



206-0006  
Fig. 2  
11.5cm  
Iris  
Curved



206-0007  
Fig. 3  
11.5cm  
Iris



206-0008  
Fig. 1  
11.5cm  
Angular Saw edge

206-0009  
Fig. 2  
11.5cm  
Angular

Web: [www.mabsonortho.com](http://www.mabsonortho.com)

Tel: +92 52 3570603  
Fax: +92 52 3570604  
Moh. Islamabad Union Council  
Near Imran Market Ugoki Morre,  
Sialkot-51310 Pakistan.





MABSON ORTHO

# MABSON INDUSTRY

Manufacturer & Exporter of Surgical, Dental & Orthopedic Instruments

## Gum Scissors

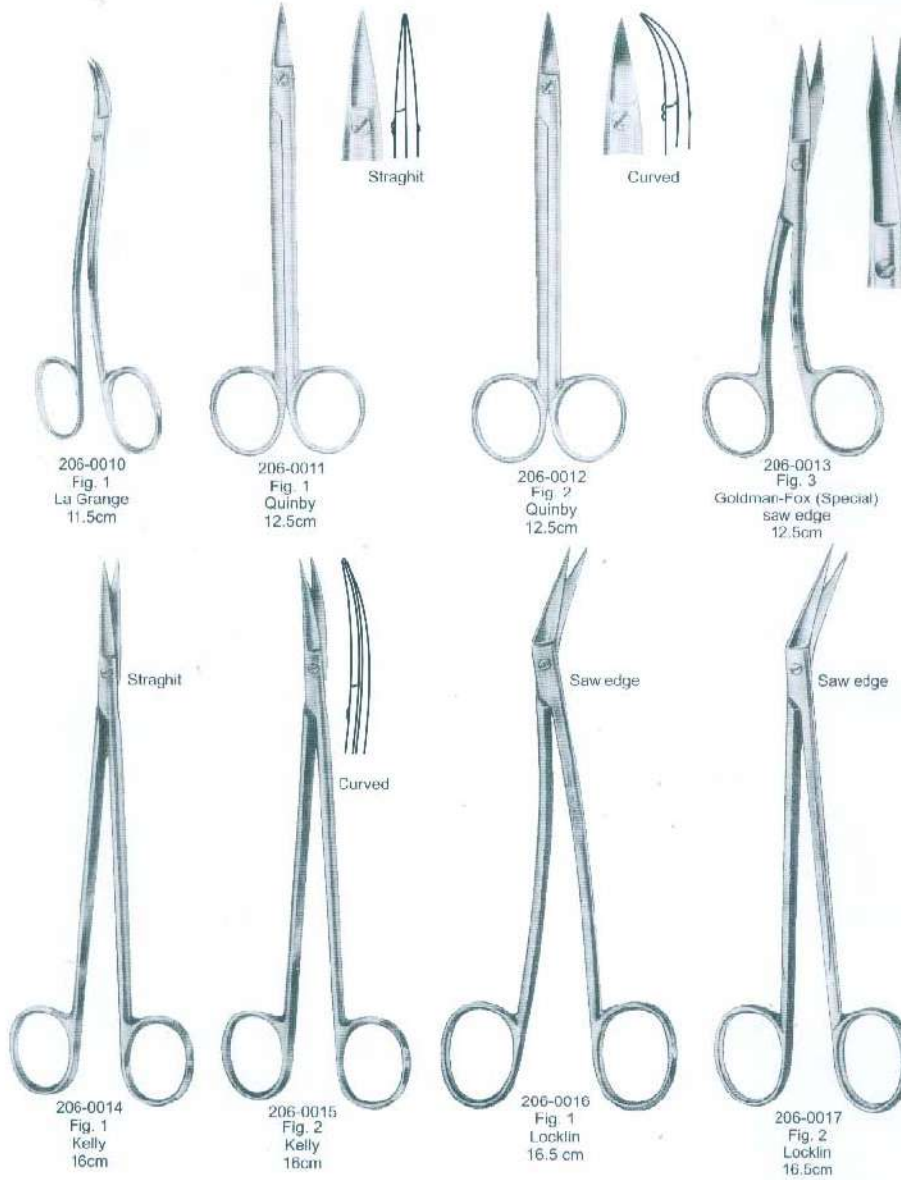

Web: [www.mabsonortho.com](http://www.mabsonortho.com)

Tel: +92 52 3570603  
Fax: +92 52 3570604  
Moh. Islamabad Union Council  
Near Imran Market Ugoki Morre,  
Sialkot-51310 Pakistan.



MABSON ORTHO

# MABSON INDUSTRY

Manufacturer & Exporter of Surgical, Dental & Orthopedic Instruments

## Surgical Scissors

Very fine points

Very fine points



206-0018  
Fig. 1  
Noyes (Castroviejo)  
12cm



206-0019  
Fig. 1  
14.5cm

Blunt points



206-0020  
Fig. 1  
Westcott  
11cm

Sharp points



206-0021  
Fig. 2  
Westcott  
11cm

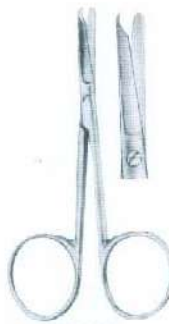

206-0022  
Fig. 1  
Spencer  
9cm



206-0023  
Fig. 2  
Spencer  
13cm



206-0024  
Fig. 1  
Neumann  
12.5cm

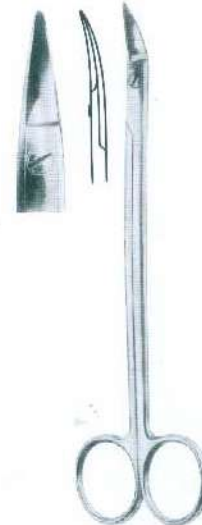

206-0025  
Fig. 1  
Dean  
17cm

Web: [www.mabsonortho.com](http://www.mabsonortho.com)

Tel: +92 52 3570603  
Fax: +92 52 3570604  
Moh. Islamabad Union Council  
Near Imran Market Ugoki Morre,  
Sialkot-51310 Pakistan.



MABSON ORTHO

# MABSON INDUSTRY

Manufacturer & Exporter of Surgical, Dental & Orthopedic Instruments

## Surgical Scissors

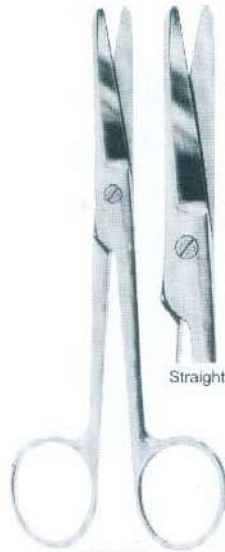

206-0026  
Fig. 1  
Mayo  
14.5cm

Straight

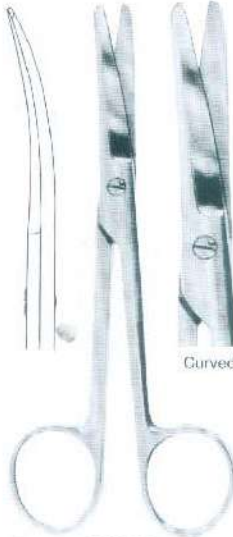

206-0027  
Fig. 2  
Mayo  
14.5cm

Curved



206-0028  
Fig. 2  
Metzenbaum  
14.5cm

Straight

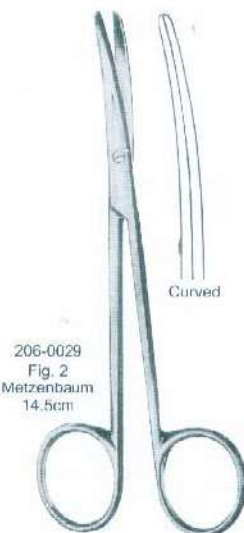

206-0029  
Fig. 2  
Metzenbaum  
14.5cm

Curved



206-0030  
Fig. 2  
Metzenbaum-delicate  
14.5cm

Straight

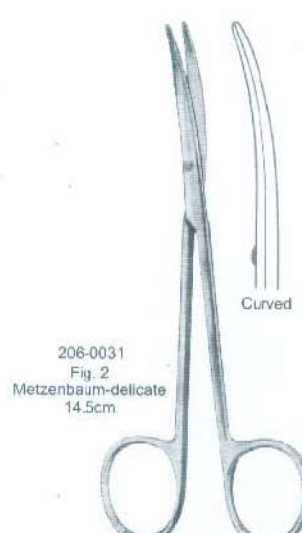

206-0031  
Fig. 2  
Metzenbaum-delicate  
14.5cm

Curved

Web: [www.mabsonortho.com](http://www.mabsonortho.com)

Tel: +92 52 3570603  
Fax: +92 52 3570604  
Moh. Islamabad Union Council  
Near Imran Market Ugoki Morre,  
Sialkot-51310 Pakistan.



MABSON ORTHO

# MABSON INDUSTRY

Manufacturer & Exporter of Surgical, Dental & Orthopedic Instruments

## Haemostatic Forceps

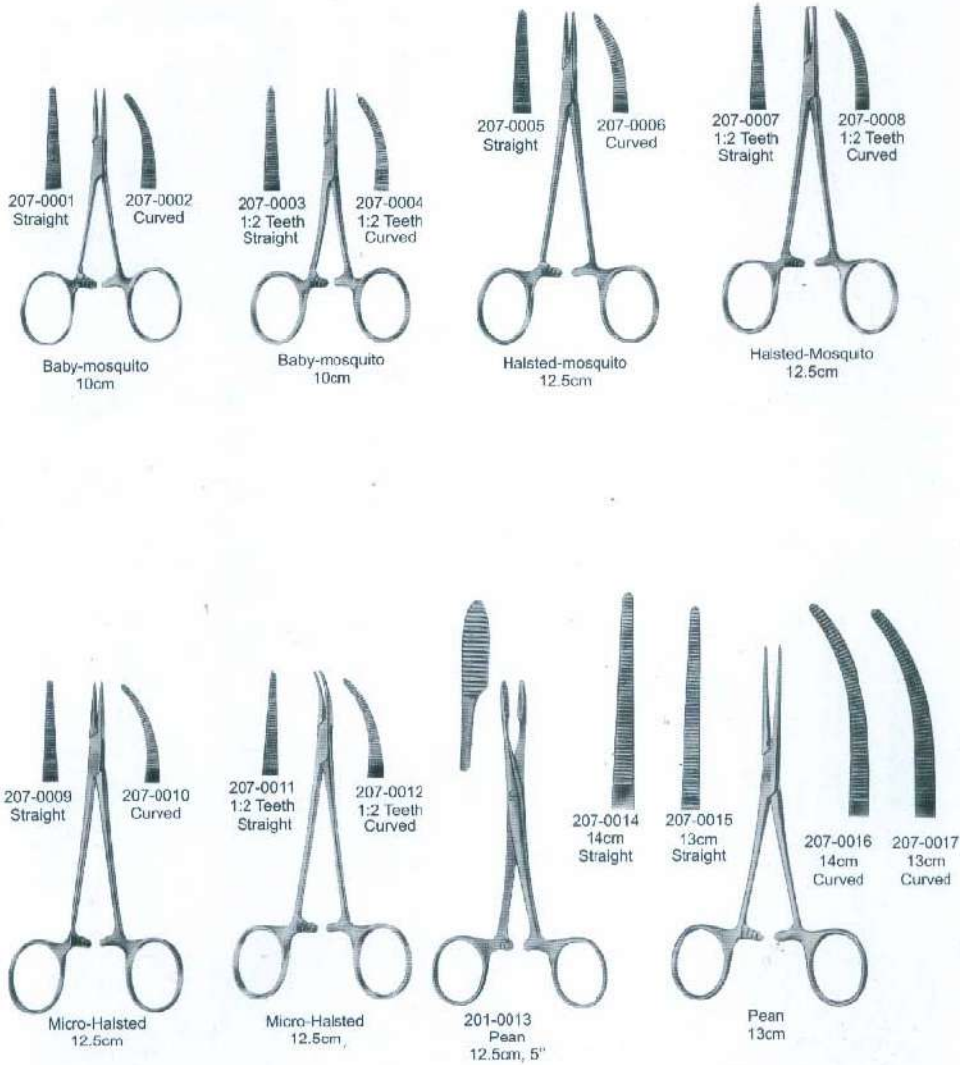

Web: [www.mabsonortho.com](http://www.mabsonortho.com)

Tel: +92 52 3570603  
Fax: +92 52 3570604  
Moh. Islamabad Union Council  
Near Imran Market Ugoki Morre,  
Sialkot-51310 Pakistan.



MABSON ORTHO

# MABSON INDUSTRY

Manufacturer & Exporter of Surgical, Dental & Orthopedic Instruments

## Haemostatic Forceps

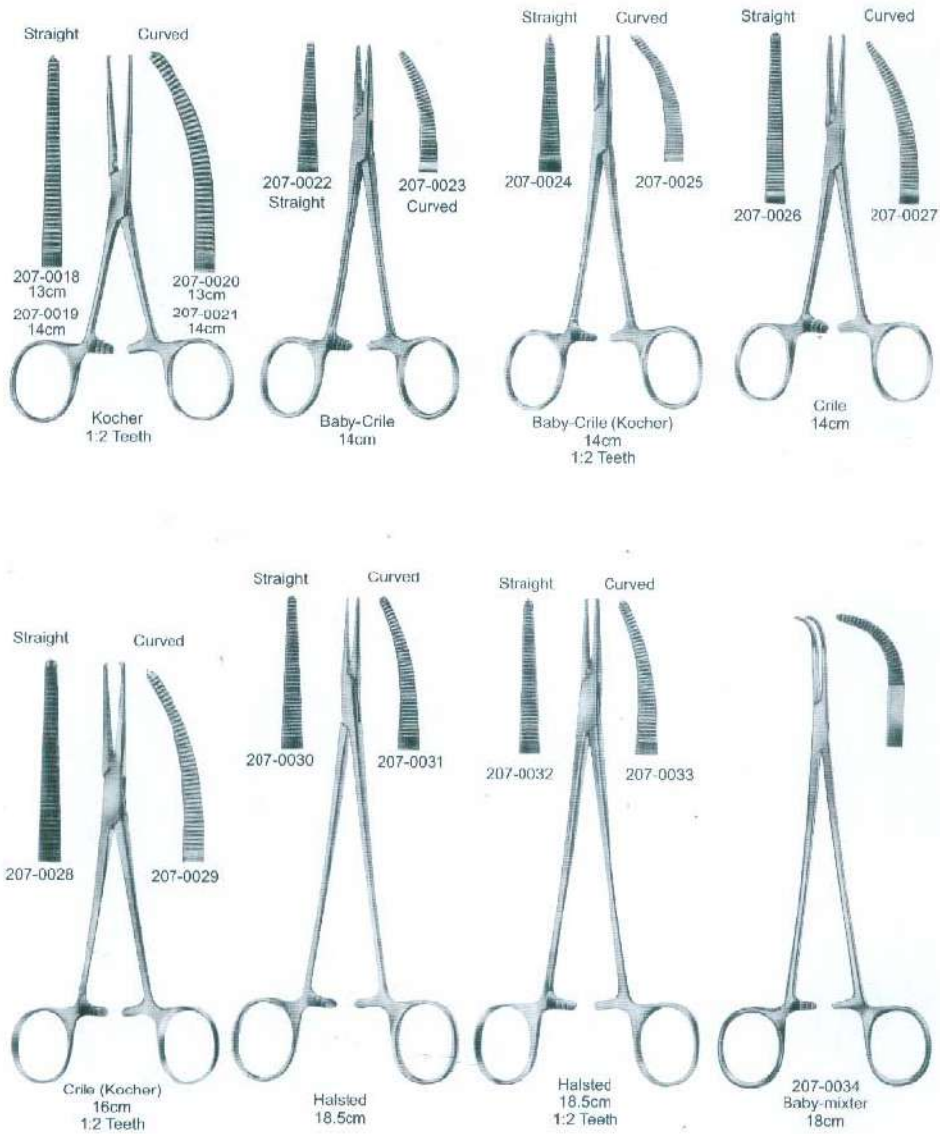

Web: [www.mabsonortho.com](http://www.mabsonortho.com)

Tel: +92 52 3570603  
Fax: +92 52 3570604  
Moh. Islamabad Union Council  
Near Imran Market Ugoki Morre,  
Sialkot-51310 Pakistan.



MABSON ORTHO

# MABSON INDUSTRY

Manufacturer & Exporter of Surgical, Dental & Orthopedic Instruments

## Sponge and Dressing Forceps



207-0035  
Without Ratchet  
14.5cm

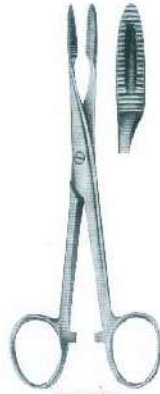

207-0036  
With Ratchet  
14.5cm



207-0037  
Curved  
17.5cm



207-0038  
Curved  
21cm

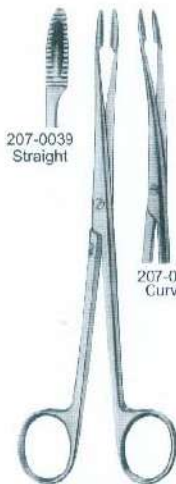

207-0039  
Straight

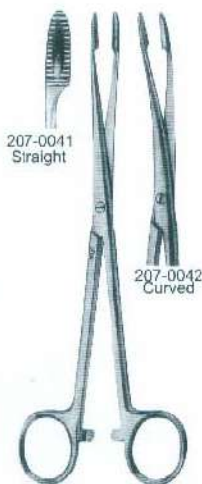

207-0041  
Straight

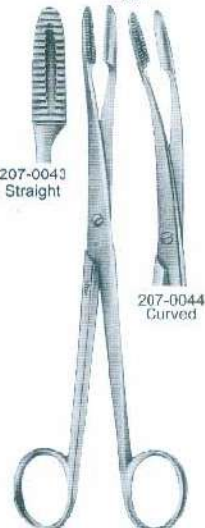

207-0043  
Straight

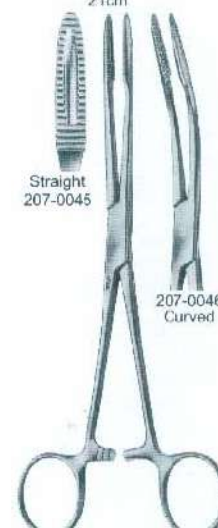

Straight  
207-0045



207-0040  
Curved



207-0042  
Curved

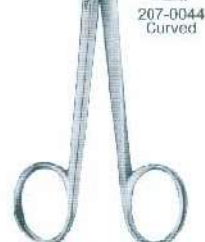

207-0044  
Curved

Without Ratchet  
18cm

With Ratchet  
18cm

Without Ratchet  
20cm

With Ratchet  
20cm

Web: [www.mabsonortho.com](http://www.mabsonortho.com)

Tel: +92 52 3570603  
Fax: +92 52 3570604  
Moh. Islamabad Union Council  
Near Imran Market Ugoki Morre,  
Sialkot-51310 Pakistan.



MABSON ORTHO

# MABSON INDUSTRY

Manufacturer & Exporter of Surgical, Dental & Orthopedic Instruments

## Towel Clamps Sterilizing Forceps for sterile Instruments

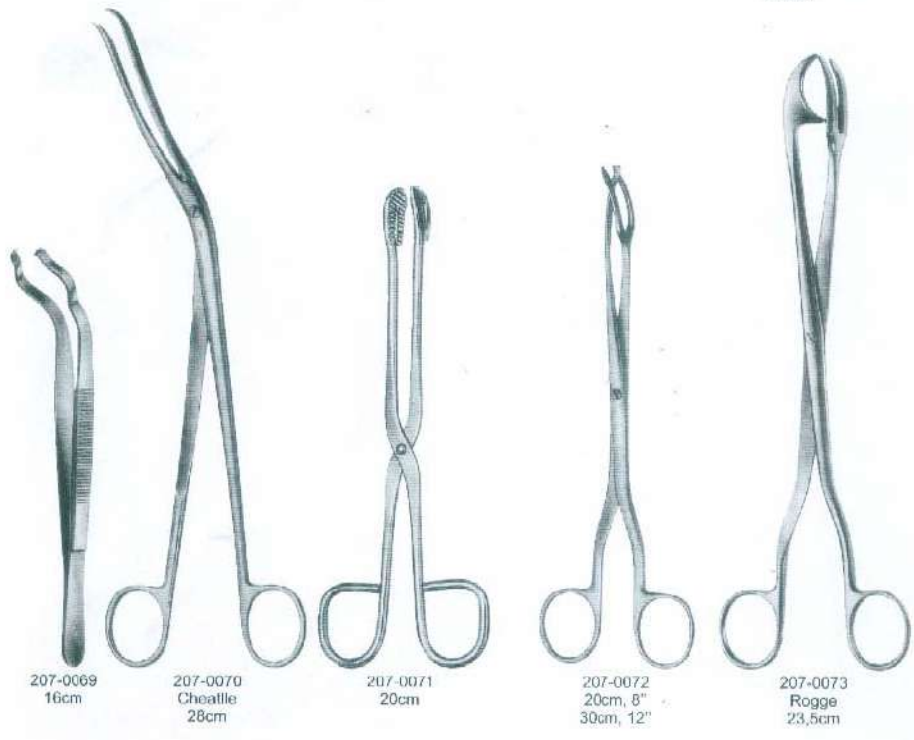
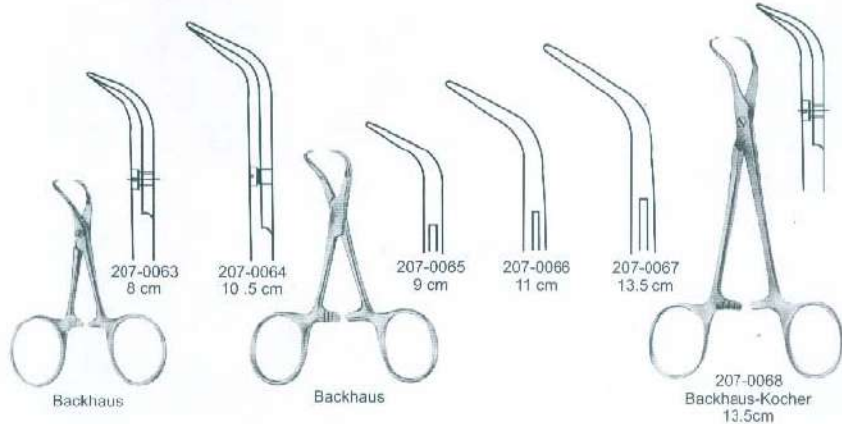

Web: [www.mabsonortho.com](http://www.mabsonortho.com)

Tel: +92 52 3570603  
Fax: +92 52 3570604  
Moh. Islamabad Union Council  
Near Imran Market Ugoki Morre,  
Sialkot-51310 Pakistan.



MABSON ORTHO

# MABSON INDUSTRY

Manufacturer & Exporter of Surgical, Dental & Orthopedic Instruments

## Skin hook and Retractors

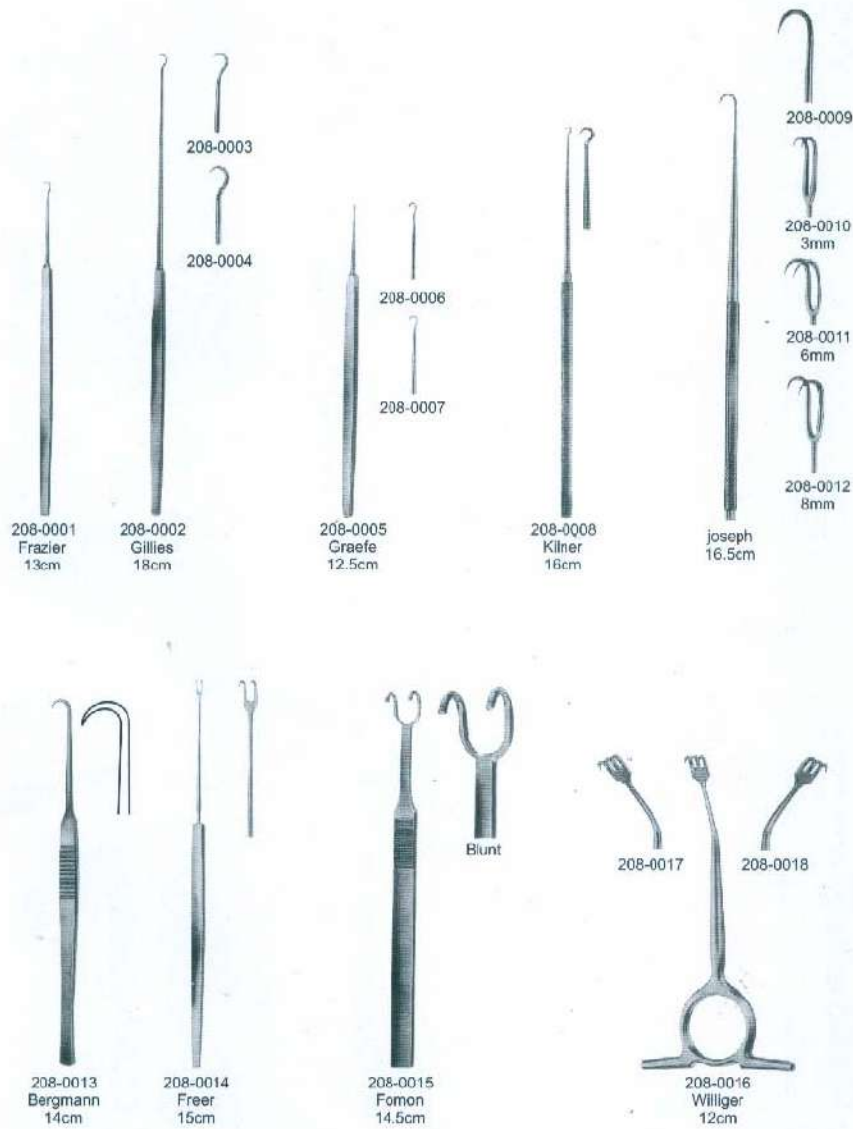

Web: [www.mabsonortho.com](http://www.mabsonortho.com)

Tel: +92 52 3570603  
Fax: +92 52 3570604  
Moh. Islamabad Union Council  
Near Imran Market Ugoki Morre,  
Sialkot-51310 Pakistan.





MABSON ORTHO

# MABSON INDUSTRY

Manufacturer & Exporter of Surgical, Dental & Orthopedic Instruments

## Retractors



208-0019  
Small Curve Sharp  
16.5cm

208-0020  
208-0021  
208-0022  
208-0023

208-0024  
Small Curve Blunt  
16.5cm

208-0025  
208-0026  
208-0027  
208-0028

208-0029  
Flexible Shaft, Sharp  
16.5cm

208-0030  
208-0031

208-0032  
Blunt  
208-0033  
Toothed  
Strandell-Stille  
18cm

208-0034  
208-0035  
Rrtractors  
16cm

208-0036  
18×6mm  
208-0037  
25×6mm  
Langenbeck-Green  
16cm

11×13 mm  
208-0038  
16cm

Web: [www.mabsonortho.com](http://www.mabsonortho.com)

Tel: +92 52 3570603  
Fax: +92 52 3570604  
Moh. Islamabad Union Council  
Near Imran Market Ugoki Morre,  
Sialkot-51310 Pakistan.



MABSON ORTHO

# MABSON INDUSTRY

Manufacturer & Exporter of Surgical, Dental & Orthopedic Instruments

## Retractors



Web: [www.mabsonortho.com](http://www.mabsonortho.com)

Tel: +92 52 3570603  
Fax: +92 52 3570604  
Moh. Islamabad Union Council  
Near Imran Market Ugoki Morre,  
Sialkot-51310 Pakistan.



MABSON ORTHO

# MABSON INDUSTRY

Manufacturer & Exporter of Surgical, Dental & Orthopedic Instruments

## Cheek Retractors



Middeldorpf



208-0053  
15×15mm  
22cm



208-0054  
20×22mm  
21.5cm



208-0055  
28×28mm  
23.5cm



208-0056  
Greene  
22.5cm



208-0057  
Buchs  
20.5cm



Langenbeck  
21cm



208-0058  
28×10mm



208-0059  
28×14mm



208-0060  
33×14mm



208-0061  
28×18mm



208-0062  
40×10mm



208-0063  
40×13mm



208-0064  
Kocher  
21cm



23×8mm



208-0066  
Blunt

208-0065  
Alm (Sharp)  
7cm



208-0067  
Alm (Sharp)  
10cm

208-0068  
Blunt

Web: [www.mabsonortho.com](http://www.mabsonortho.com)

Tel: +92 52 3570603  
Fax: +92 52 3570604  
Moh. Islamabad Union Council  
Near Imran Market Ugoki Morre,  
Sialkot-51310 Pakistan.



MABSON ORTHO

# MABSON INDUSTRY

Manufacturer & Exporter of Surgical, Dental & Orthopedic Instruments

## Elevators

5mm



208-0069  
Williger  
16.5cm

6mm

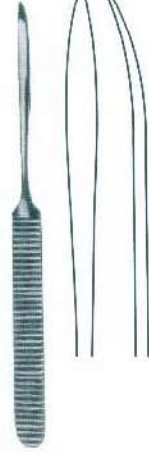

208-0070  
Williger  
17cm

4.5mm

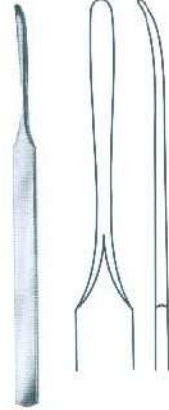

208-0071  
Konig  
15.5mm

4.5mm

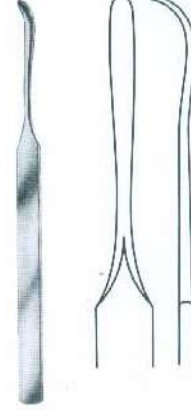

208-0072  
Konig  
15.5cm



208-0073  
Freer  
19cm



208-0074  
Freer  
18.5cm



208-0075  
Freer-Yasargil  
18.5cm



208-0076  
Kendzia  
17cm

Web: [www.mabsonortho.com](http://www.mabsonortho.com)

Tel: +92 52 3570603  
Fax: +92 52 3570604  
Moh. Islamabad Union Council  
Near Imran Market Ugoki Morre,  
Sialkot-51310 Pakistan.



MABSON ORTHO

# MABSON INDUSTRY

Manufacturer & Exporter of Surgical, Dental & Orthopedic Instruments

## Elevators

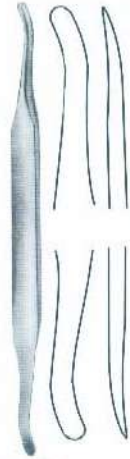

208-0077  
Saldin  
19.5cm



208-0078  
Saldin  
19.5cm



208-0079  
Chompret  
15cm



208-0080 208-0081



208-0082 208-0083



208-0084  
Freer  
16cm



208-0085  
Freer  
16cm



208-0086  
Pertsch, mod  
14.5cm



208-0087  
Mead  
16.5cm



208-0088  
Mead  
18cm

Web: [www.mabsonortho.com](http://www.mabsonortho.com)

Tel: +92 52 3570603  
Fax: +92 52 3570604  
Moh. Islamabad Union Council  
Near Imran Market Ugoki Morre,  
Sialkot-51310 Pakistan.



MABSON ORTHO

# MABSON INDUSTRY

Manufacturer & Exporter of Surgical, Dental & Orthopedic Instruments

## Elevators

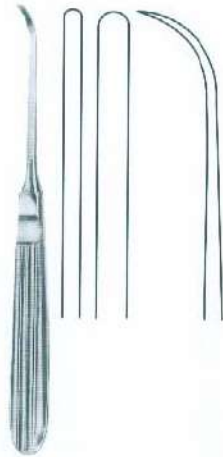

208-0089 (3mm)  
208-0090 (6mm)  
Raspatories  
17cm

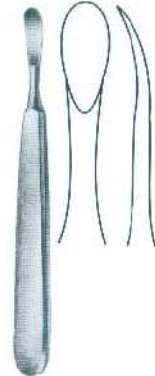

208-0081  
8mm  
Trelat  
14cm



208-0092  
5mm  
Kunig  
15.5cm



208-0093  
4.2mm  
Williger  
14cm



208-0094  
Williger  
16cm

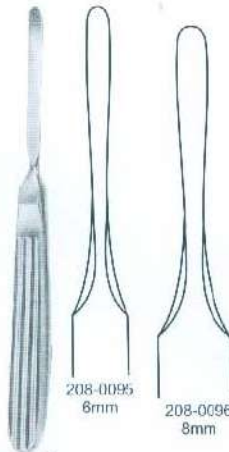

Raspatories  
16.5cm

208-0095  
6mm

208-0096  
8mm



208-0097  
Obwegeser  
17cm

9mm Sharp



Raspatories  
20cm



208-0098  
5mm



208-0099  
8mm



208-0100  
Tessie  
22cm

Web: [www.mabsonortho.com](http://www.mabsonortho.com)

Tel: +92 52 3570603  
Fax: +92 52 3570604  
Moh. Islamabad Union Council  
Near Imran Market Ugoki Morre,  
Sialkot-51310 Pakistan.



MABSON ORTHO

# MABSON INDUSTRY

Manufacturer & Exporter of Surgical, Dental & Orthopedic Instruments

## Chisels and Gouges

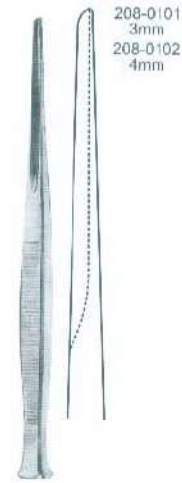

Partsch  
17cm

208-0101  
3mm  
208-0102  
4mm



208-0103  
Freer  
16cm

4mm



208-0104  
Freer  
16cm

4mm  
Curved



Lucas  
16cm

208-0105  
4mm  
208-0106  
6mm



Lucas  
16cm

208-0107  
3mm  
208-0108  
5mm



Lambotte  
12.5cm

208-0109  
4mm  
208-0110  
6mm  
208-0111  
8mm  
208-0112  
10mm  
208-0113  
12mm  
208-0114  
15mm



14cm

208-0115  
4mm  
208-0116  
6mm  
208-0117  
8mm



Partsch  
14cm

208-0118  
3mm  
208-0119  
4mm  
208-0120  
5mm  
208-0121  
6mm



Partsch  
17cm

208-0122  
3mm  
208-0123  
4mm  
208-0124  
5mm  
208-0125  
6mm  
208-0126  
7mm



Partsch  
14cm

208-0127  
3mm  
208-0128  
4mm

Web: [www.mabsonortho.com](http://www.mabsonortho.com)

Tel: +92 52 3570603  
Fax: +92 52 3570604  
Moh. Islamabad Union Council  
Near Imran Market Ugoki Morre,  
Sialkot-51310 Pakistan.



MABSON ORTHO

# MABSON INDUSTRY

Manufacturer & Exporter of Surgical, Dental & Orthopedic Instruments

## Rubber Dam Instruments

Clamp forceps



209-0001  
Ivory light weight  
17cm

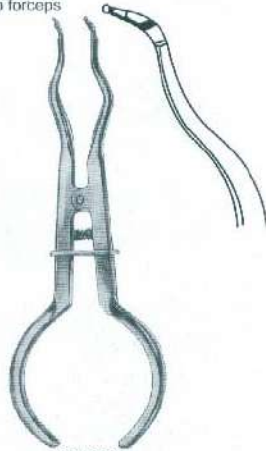

209-0002  
Brewer  
17.5cm

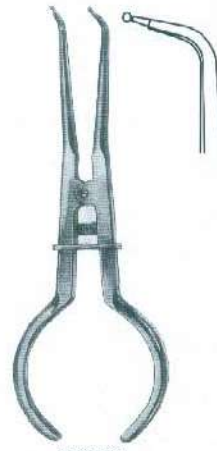

209-0003  
Stokes  
17.5cm

Punch forceps



209-0004  
Ainsworth  
17cm



209-0005  
Ivory  
17cm

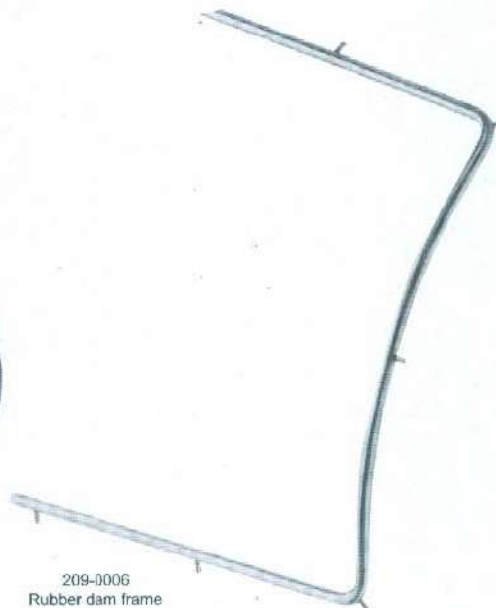

209-0006  
Rubber dam frame

Web: [www.mabsonortho.com](http://www.mabsonortho.com)

Tel: +92 52 3570603  
Fax: +92 52 3570604  
Moh. Islamabad Union Council  
Near Imran Market Ugoki Morre,  
Sialkot-51310 Pakistan.





MABSON ORTHO

**MABSON  
INDUSTRY**

Manufacturer & Exporter of Surgical, Dental & Orthopedic Instruments

**Tissue Pliers**

210-0001  
Adson, 12cm



210-0002  
Adson 1x2, 12cm



210-0003  
Fig. 1  
Semken-Taylor  
12.5 cm



210-0004  
Fig. 2  
Semken-Taylor  
12.5cm



210-0005  
Fig. 1  
Semken-Taylor 1x2  
12.5cm



210-0006  
Fig. 2  
Semken-Taylor 1x2  
12.5cm



210-0007  
12cm



210-0008  
11.5cm



210-0009  
11.5cm



210-0010  
11.5cm



Web: [www.mabsonortho.com](http://www.mabsonortho.com)

Tel: +92 52 3570603  
Fax: +92 52 3570604  
Moh. Islamabad Union Council  
Near Imran Market Ugoki Morre,  
Sialkot-51310 Pakistan.



MABSON ORTHO

# MABSON INDUSTRY

Manufacturer & Exporter of Surgical, Dental & Orthopedic Instruments

## Cotton and Dressing Pliers

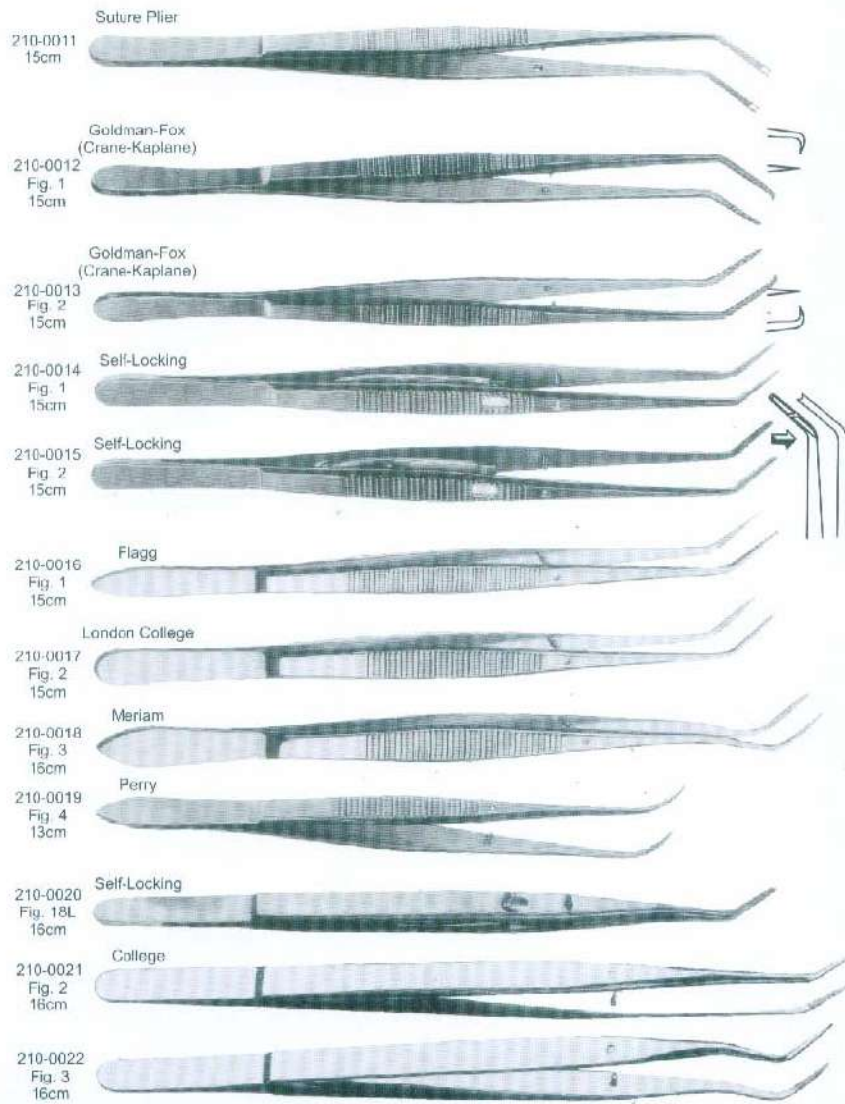

Web: [www.mabsonortho.com](http://www.mabsonortho.com)

Tel: +92 52 3570603  
Fax: +92 52 3570604  
Moh. Islamabad Union Council  
Near Imran Market Ugoki Morre,  
Sialkot-51310 Pakistan.



MABSON ORTHO

**MABSON  
INDUSTRY**

Manufacturer & Exporter of Surgical, Dental & Orthopedic Instruments

## Scalpel Handles



211-0001  
No.3L



211-0002  
ERGONOMIC



211-0003  
No.7



211-0004



211-0005



211-0006

Web: [www.mabsonortho.com](http://www.mabsonortho.com)

Tel: +92 52 3570603  
Fax: +92 52 3570604  
Moh. Islamabad Union Council  
Near Imran Market Ugoki Morre,  
Sialkot-51310 Pakistan.



MABSON ORTHO

# MABSON INDUSTRY

Manufacturer & Exporter of Surgical, Dental & Orthopedic Instruments

## Scalpel Handles



211-0007  
No.4L



211-0008  
No.4



211-0009  
No.10



211-0010  
No.9



211-0011  
No. 3



211-0012  
BARRON  
For "B.P." type blades  
for use with No's  
10,11,12 & 15 blades  
135mm (5.1/4")

Web: [www.mabsonortho.com](http://www.mabsonortho.com)

Tel: +92 52 3570603  
Fax: +92 52 3570604  
Moh. Islamabad Union Council  
Near Imran Market Ugoki Morre,  
Sialkot-51310 Pakistan.



MABSON ORTHO

# MABSON INDUSTRY

Manufacturer & Exporter of Surgical, Dental & Orthopedic Instruments

## Handles Reference Guide



211-0013  
Single ended  
Knurling round



211-0014  
Double ended  
Knurling round



211-0015  
Single ended  
octangle serrated



211-0016  
Double ended  
octangle serrated



211-0017  
Single ended  
hollow round



211-0018  
Double ended  
hollow round



211-0019  
Double ended  
hollow round grooved



211-0020  
Double ended  
swiss pattern octangle

Web: [www.mabsonortho.com](http://www.mabsonortho.com)

Tel: +92 52 3570603  
Fax: +92 52 3570604  
Moh. Islamabad Union Council  
Near Imran Market Ugoki Morre,  
Sialkot-51310 Pakistan.



MABSON ORTHO

# MABSON INDUSTRY

Manufacturer & Exporter of Surgical, Dental & Orthopedic Instruments

## Micro, needle Holders



212-0001  
CASTROVIEJO  
145mm (5.3/4")  
With catch



212-0002  
CASTROVIEJO  
145mm (5.3/4")  
With catch



212-0003  
ARRUGA  
135mm (5.1/4")



212-0004  
BARRAQUER  
120mm (4.3/4")  
With catch



212-0005  
BARRAQUER  
120mm (4.3/4")  
Without catch

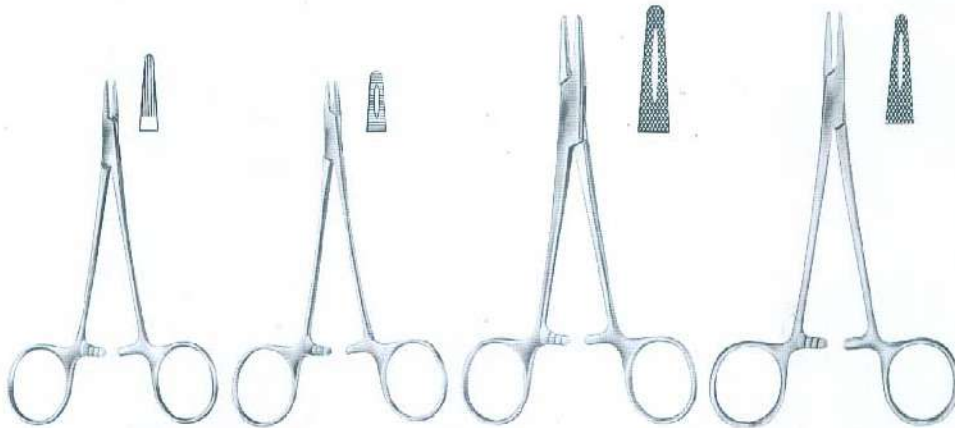

212-0006  
CONVERSE  
125mm (5")

212-0007  
DERF  
120mm (4.3/4")

212-0008  
MAYO (DUNHILL)  
160mm (6.1/4")

212-0009  
MAYO  
180mm (7")

Web: [www.mabsonortho.com](http://www.mabsonortho.com)

Tel: +92 52 3570603  
Fax: +92 52 3570604  
Moh. Islamabad Union Council  
Near Imran Market Ugoki Morre,  
Sialkot-51310 Pakistan.



MABSON ORTHO

# MABSON INDUSTRY

Manufacturer & Exporter of Surgical, Dental & Orthopedic Instruments

## Needle Holders

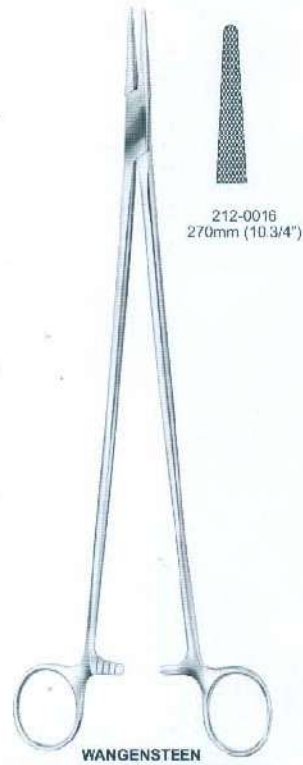
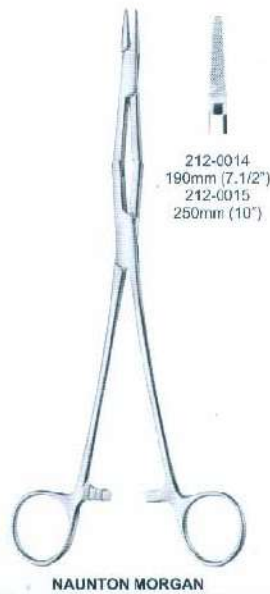

Web: [www.mabsonortho.com](http://www.mabsonortho.com)

Tel: +92 52 3570603  
Fax: +92 52 3570604  
Moh. Islamabad Union Council  
Near Imran Market Ugoki Morre,  
Sialkot-51310 Pakistan.



MABSON ORTHO

# MABSON INDUSTRY

Manufacturer & Exporter of Surgical, Dental & Orthopedic Instruments

## Needle Holders

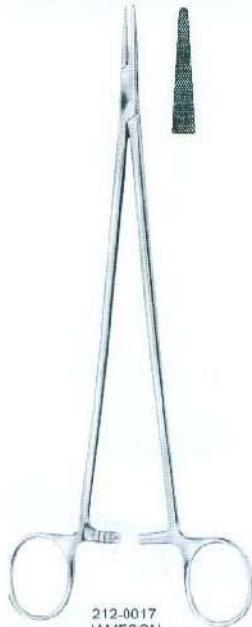

212-0017  
JAMESON  
230mm (9")



212-0018  
WRIGHT  
125mm (5")



212-0019  
GILLIES  
Combined needle holder  
and scissors  
160mm (6.14")



212-0020  
WARD  
Combined needle holder  
and scissors  
180mm (7")



212-0021  
HEANEY  
200mm (8")



OLSFEN HEGAR  
Combined needle holder  
and scissors  
212-0022 140mm (5.12")  
212-0023 165mm (6.1/2")  
212-0024 190mm (7.1/2")

Web: [www.mabsonortho.com](http://www.mabsonortho.com)

Tel: +92 52 3570603  
Fax: +92 52 3570604  
Moh. Islamabad Union Council  
Near Imran Market Ugoki Morre,  
Sialkot-51310 Pakistan.





MABSON ORTHO

# MABSON INDUSTRY

Manufacturer & Exporter of Surgical, Dental & Orthopedic Instruments

## Needle Holders

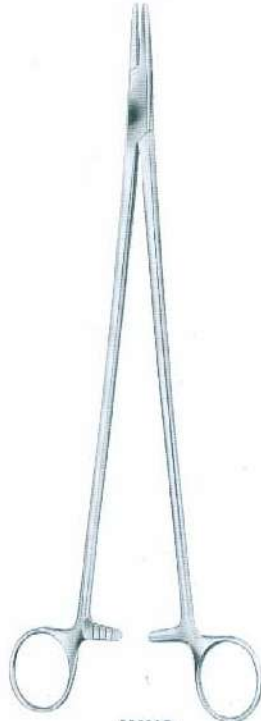

MAYO



212-0025  
MAYO (RAUMGARTNER)  
140mm (5.1/2")



212-0026  
MAYO (MASSON)  
265mm (10.1/2")



212-0027  
MAYO  
65mm (2.1/2")



212-0028  
190mm (7.1/2")



212-0029  
200mm (8")



212-0030  
230mm (9")



212-0031  
HEGAR  
200mm (8")



212-0032  
HALSEY  
125mm (5")

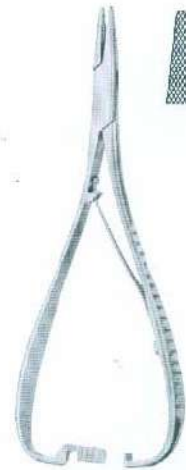

212-0033  
MATHIEU  
140mm (5.1/2")

Web: [www.mabsonortho.com](http://www.mabsonortho.com)

Tel: +92 52 3570603  
Fax: +92 52 3570604  
Moh. Islamabad Union Council  
Near Imran Market Ugoki Morre,  
Sialkot-51310 Pakistan.



MABSON ORTHO

# MABSON INDUSTRY

Manufacturer & Exporter of Surgical, Dental & Orthopedic Instruments

## Needle Holders



212-0034  
MATHIEU  
170mm (6.3/4")



212-0035  
MATHIEU  
200mm (8")



212-0036  
WEBSTER  
Smooth Jaw  
115mm (4.1/2")



212-0037  
MAYO  
150mm (6")



212-0038  
MCPHAILS  
180mm (7")



LAWRANCE  
212-0039 150mm (6")  
Lightweight  
212-0040 150mm (6")

Web: [www.mabsonortho.com](http://www.mabsonortho.com)

Tel: +92 52 3570603  
Fax: +92 52 3570604  
Moh. Islamabad Union Council  
Near Imran Market Ugoki Morre,  
Sialkot-51310 Pakistan.



MABSON ORTHO

# MABSON INDUSTRY

Manufacturer & Exporter of Surgical, Dental & Orthopedic Instruments

## Mouth Mirrors

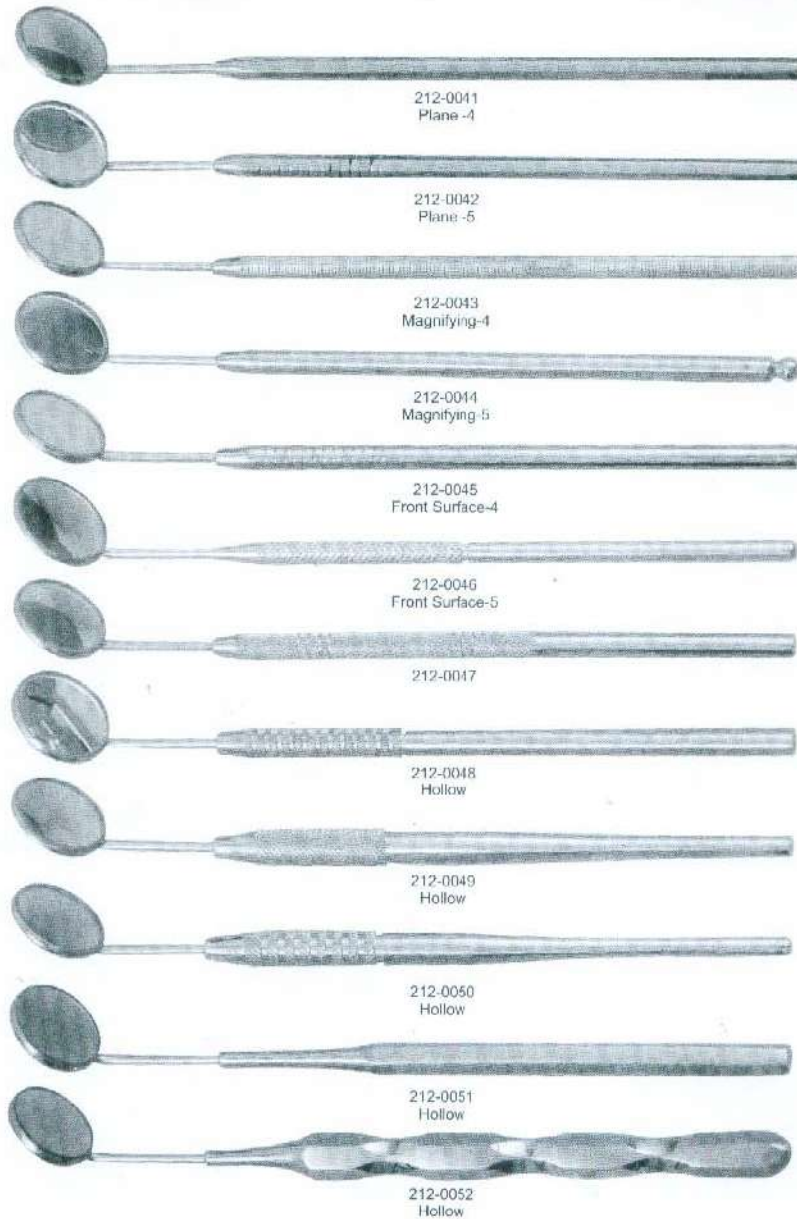

Web: [www.mabsonortho.com](http://www.mabsonortho.com)

Tel: +92 52 3570603  
Fax: +92 52 3570604  
Moh. Islamabad Union Council  
Near Imran Market Ugoki Morre,  
Sialkot-51310 Pakistan.



MABSON ORTHO

# MABSON INDUSTRY

Manufacturer & Exporter of Surgical, Dental & Orthopedic Instruments

## Explorers Endodontic Instruments

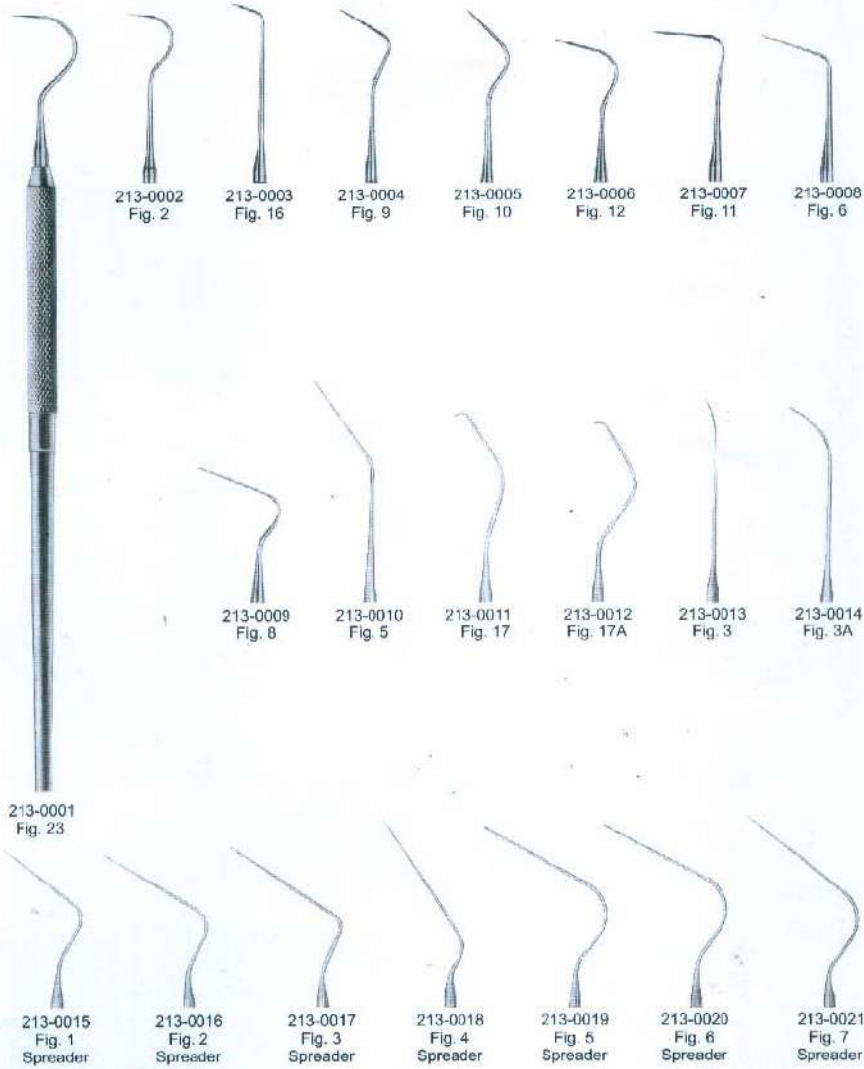

Web: [www.mabsonortho.com](http://www.mabsonortho.com)

Tel: +92 52 3570603  
Fax: +92 52 3570604  
Moh. Islamabad Union Council  
Near Imran Market Ugoki Morre,  
Sialkot-51310 Pakistan.



MABSON ORTHO

# MABSON INDUSTRY

Manufacturer & Exporter of Surgical, Dental & Orthopedic Instruments

## Explorers Probes

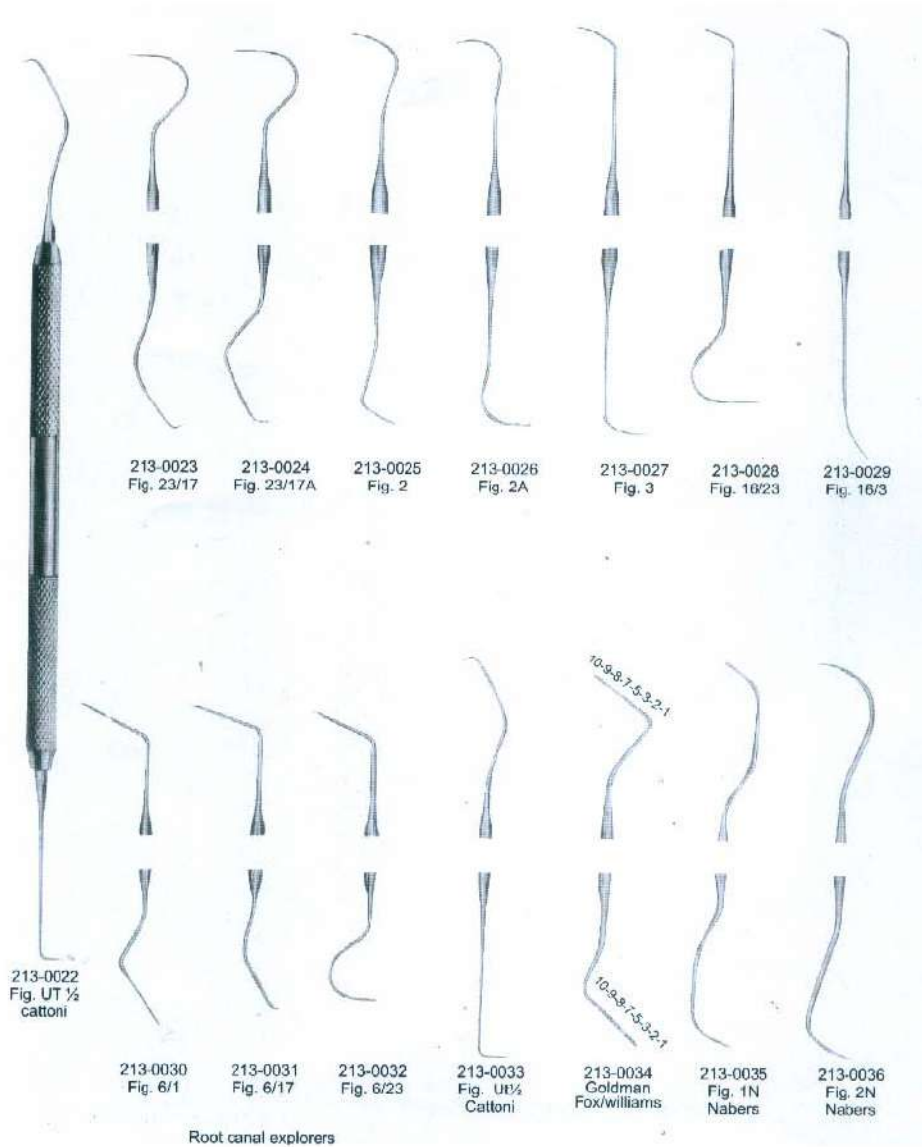

Web: [www.mabsonortho.com](http://www.mabsonortho.com)

Tel: +92 52 3570603  
Fax: +92 52 3570604  
Moh. Islamabad Union Council  
Near Imran Market Ugoki Morre,  
Sialkot-51310 Pakistan.



MABSON ORTHO

# MABSON INDUSTRY

Manufacturer & Exporter of Surgical, Dental & Orthopedic Instruments

## Explorers Endodontic Instruments

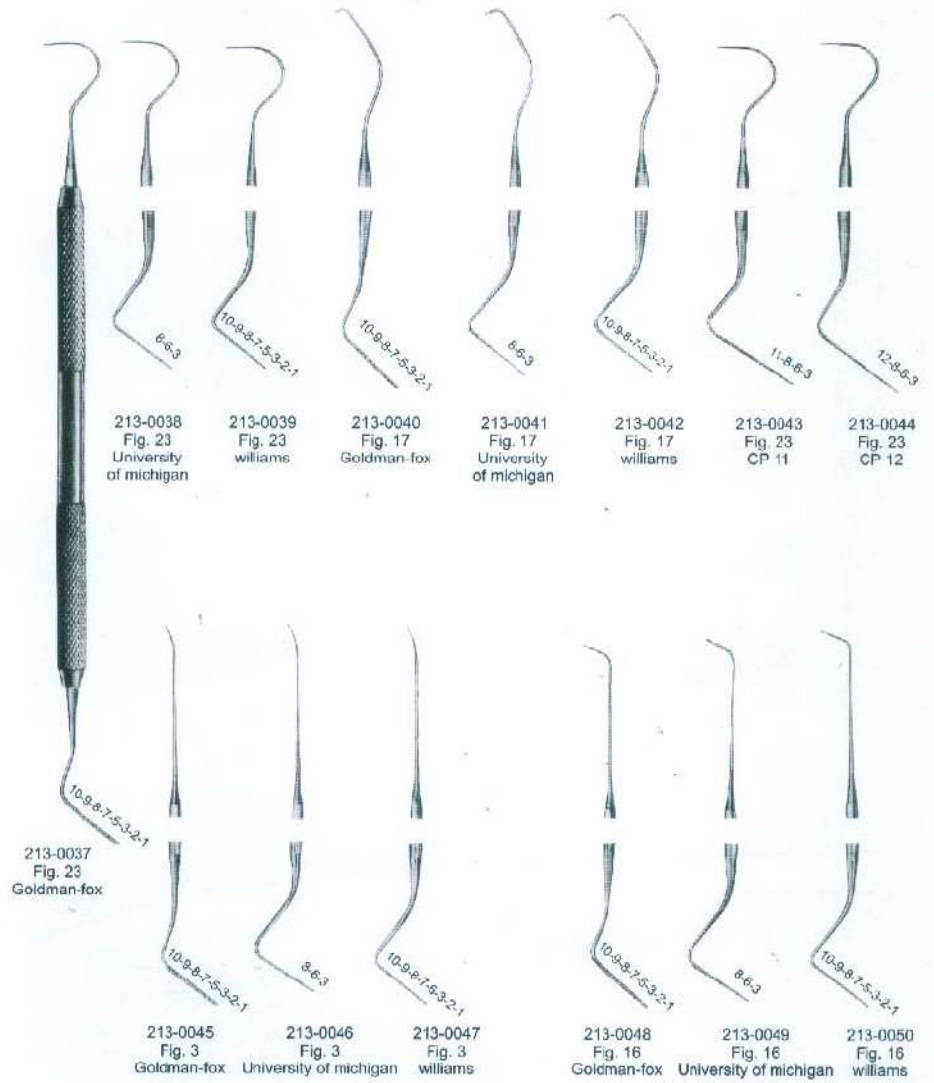

Web: [www.mabsonortho.com](http://www.mabsonortho.com)

Tel: +92 52 3570603  
Fax: +92 52 3570604  
Moh. Islamabad Union Council  
Near Imran Market Ugoki Morre,  
Sialkot-51310 Pakistan.



MABSON ORTHO

# MABSON INDUSTRY

Manufacturer & Exporter of Surgical, Dental & Orthopedic Instruments

## Periodontal Pocket probes endodontic instruments

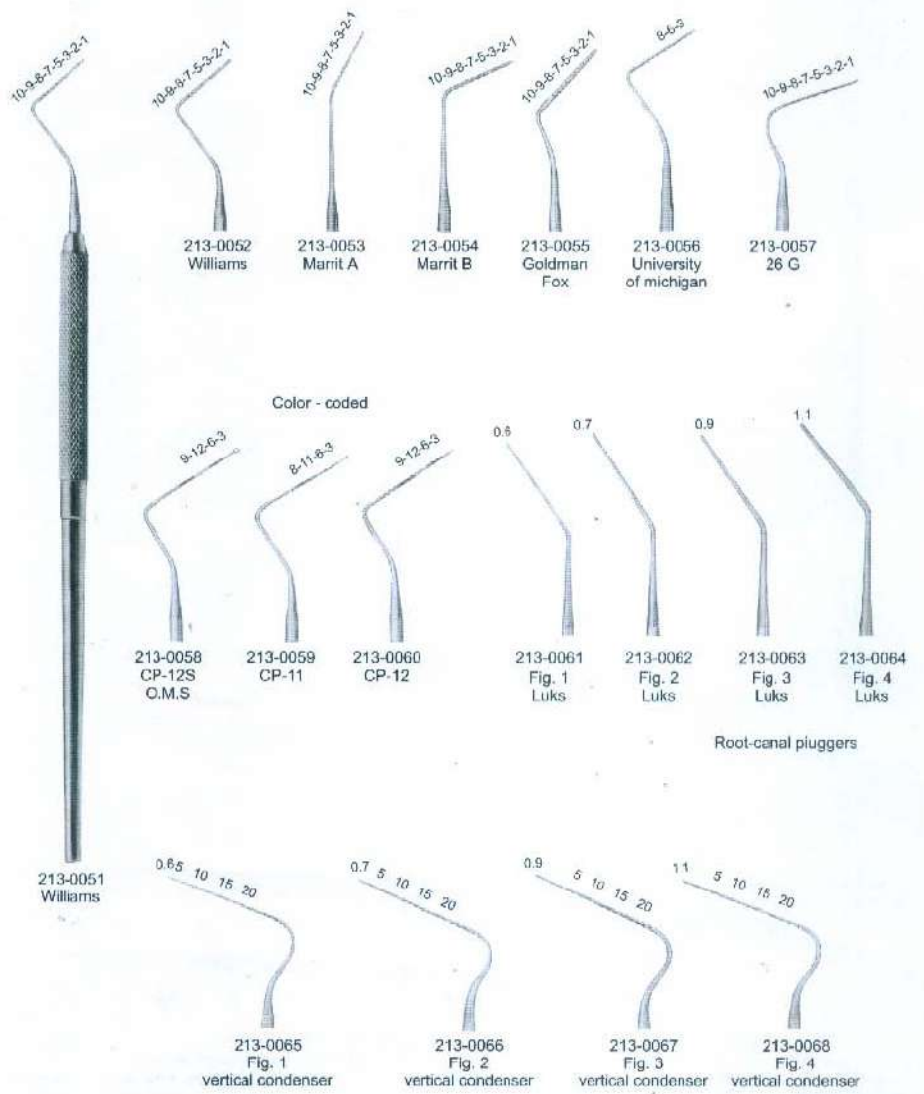

Web: [www.mabsonortho.com](http://www.mabsonortho.com)

Tel: +92 52 3570603  
Fax: +92 52 3570604  
Moh. Islamabad Union Council  
Near Imran Market Ugoki Morre,  
Sialkot-51310 Pakistan.



MABSON ORTHO

# MABSON INDUSTRY

Manufacturer & Exporter of Surgical, Dental & Orthopedic Instruments

## Filling Instruments

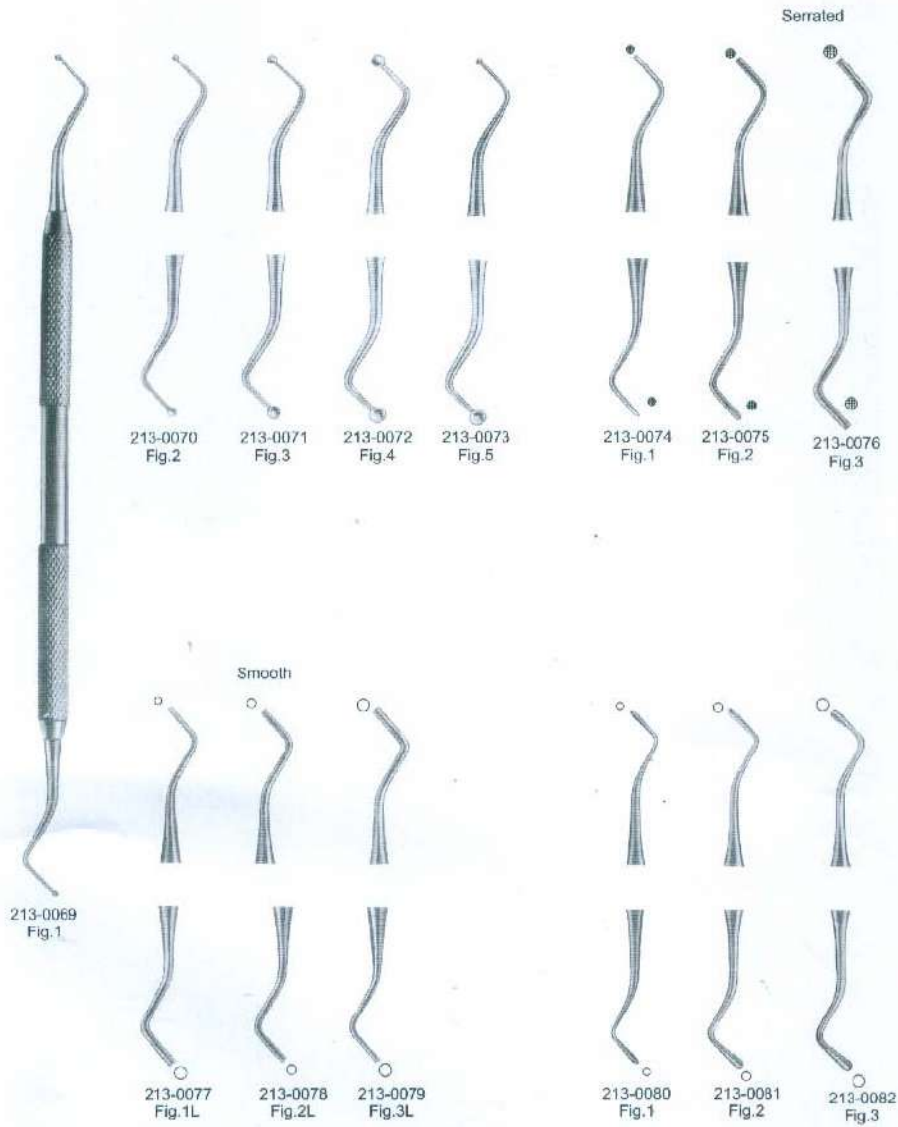

Web: [www.mabsonortho.com](http://www.mabsonortho.com)

Tel: +92 52 3570603  
Fax: +92 52 3570604  
Moh. Islamabad Union Council  
Near Imran Market Ugoki Morre,  
Sialkot-51310 Pakistan.





MABSON ORTHO

# MABSON INDUSTRY

Manufacturer & Exporter of Surgical, Dental & Orthopedic Instruments

## Filling Instruments

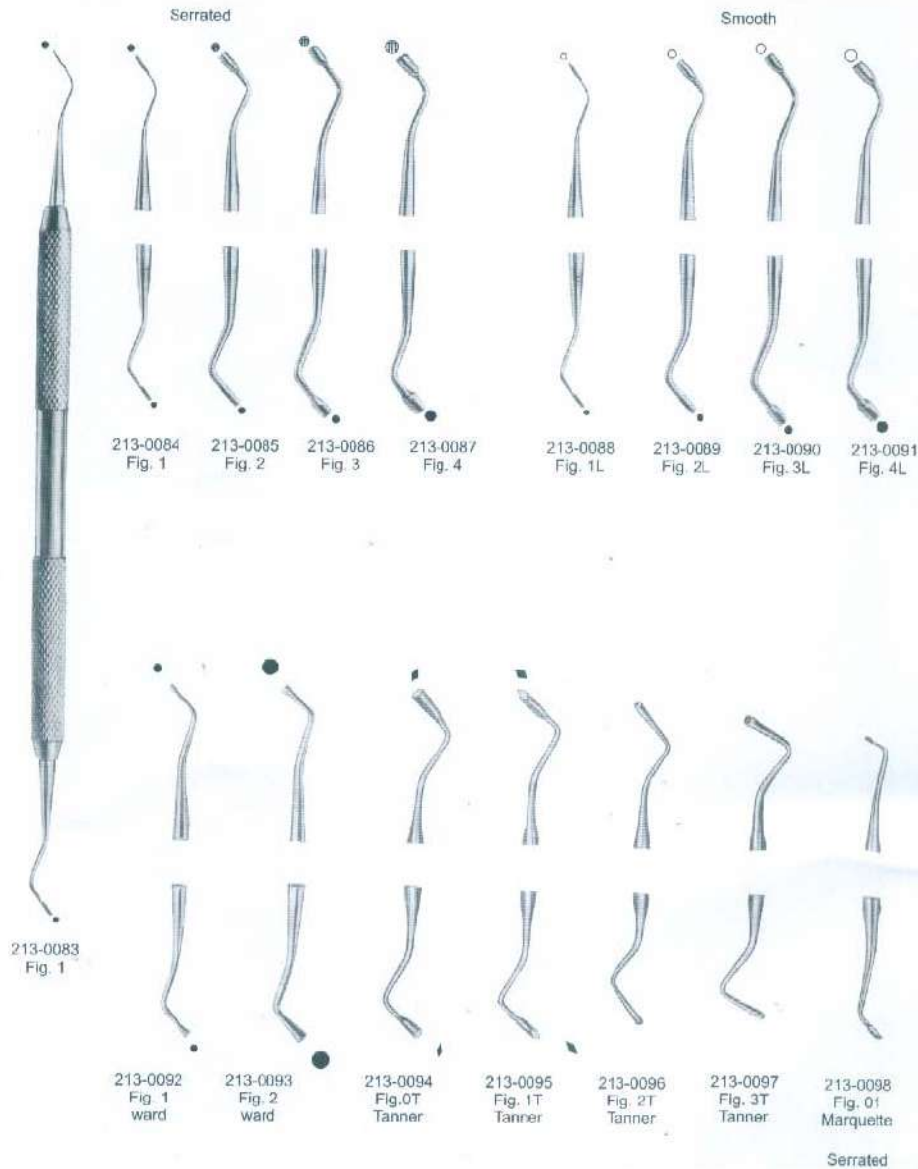

Web: [www.mabsonortho.com](http://www.mabsonortho.com)

Tel: +92 52 3570603  
Fax: +92 52 3570604  
Moh. Islamabad Union Council  
Near Imran Market Ugoki Morre,  
Sialkot-51310 Pakistan.



MABSON ORTHO

# MABSON INDUSTRY

Manufacturer & Exporter of Surgical, Dental & Orthopedic Instruments

## Filling Instruments

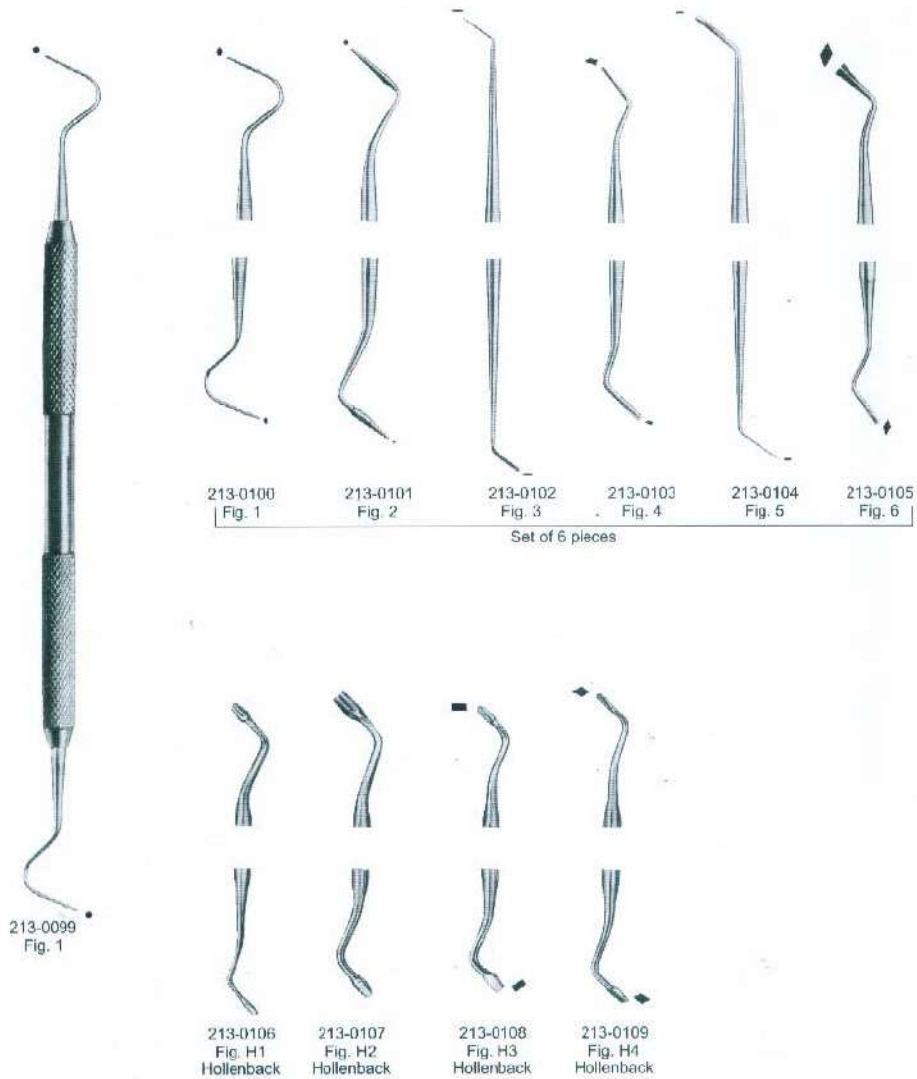

Web: [www.mabsonortho.com](http://www.mabsonortho.com)

Tel: +92 52 3570603  
Fax: +92 52 3570604  
Moh. Islamabad Union Council  
Near Imran Market Ugoki Morre,  
Sialkot-51310 Pakistan.



MABSON ORTHO

# MABSON INDUSTRY

Manufacturer & Exporter of Surgical, Dental & Orthopedic Instruments

## Filling Instruments Plastic Filling Instruments

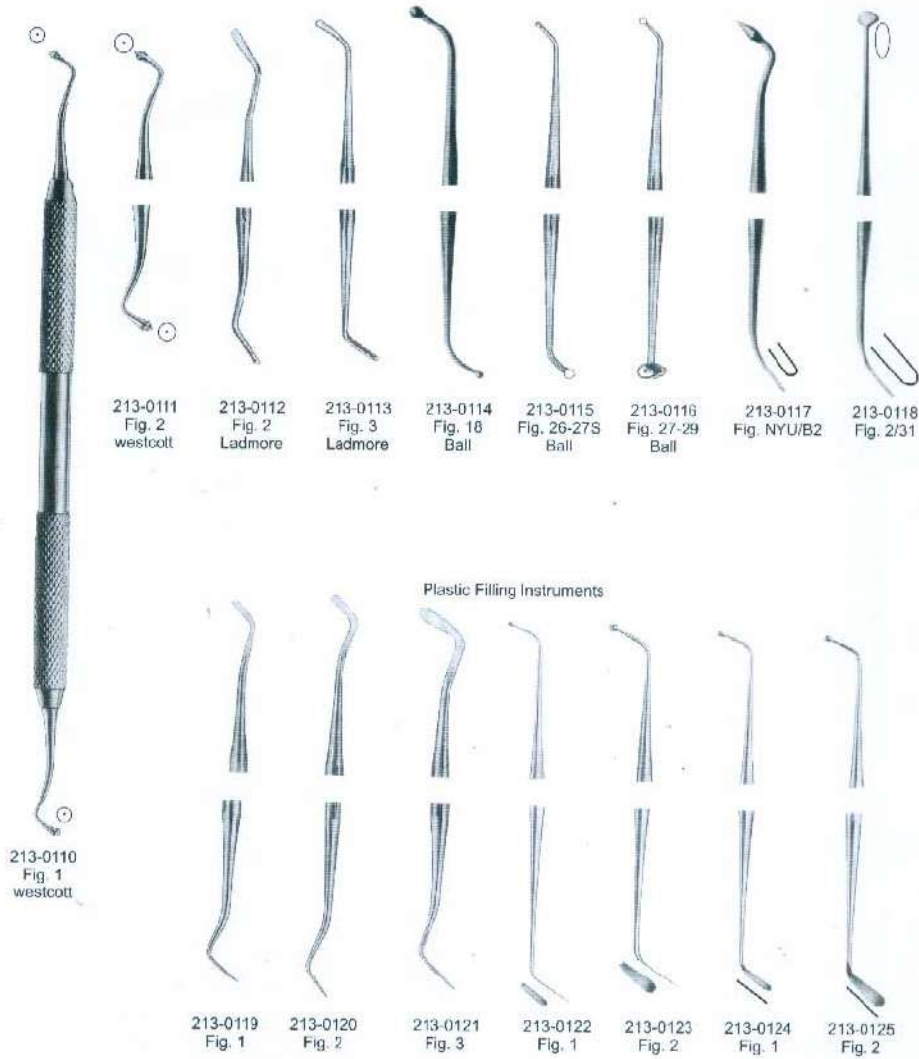

Web: [www.mabsonortho.com](http://www.mabsonortho.com)

Tel: +92 52 3570603  
Fax: +92 52 3570604  
Moh. Islamabad Union Council  
Near Imran Market Ugoki Morre,  
Sialkot-51310 Pakistan.



MABSON ORTHO

# MABSON INDUSTRY

Manufacturer & Exporter of Surgical, Dental & Orthopedic Instruments

## Plastic Filling Instruments amalgam carvers

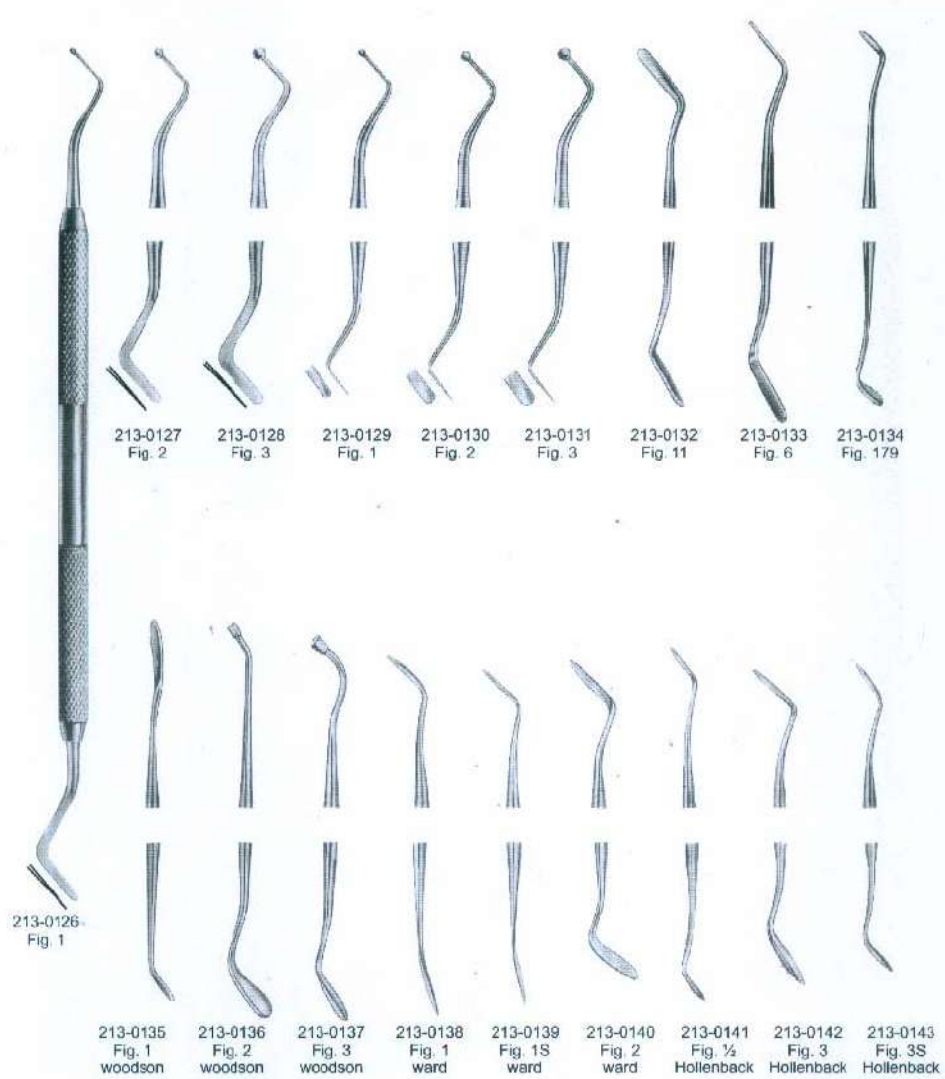

Web: [www.mabsonortho.com](http://www.mabsonortho.com)

Tel: +92 52 3570603  
Fax: +92 52 3570604  
Moh. Islamabad Union Council  
Near Imran Market Ugoki Morre,  
Sialkot-51310 Pakistan.



MABSON ORTHO

# MABSON INDUSTRY

Manufacturer & Exporter of Surgical, Dental & Orthopedic Instruments

## Amalgam Carvers operative Instruments

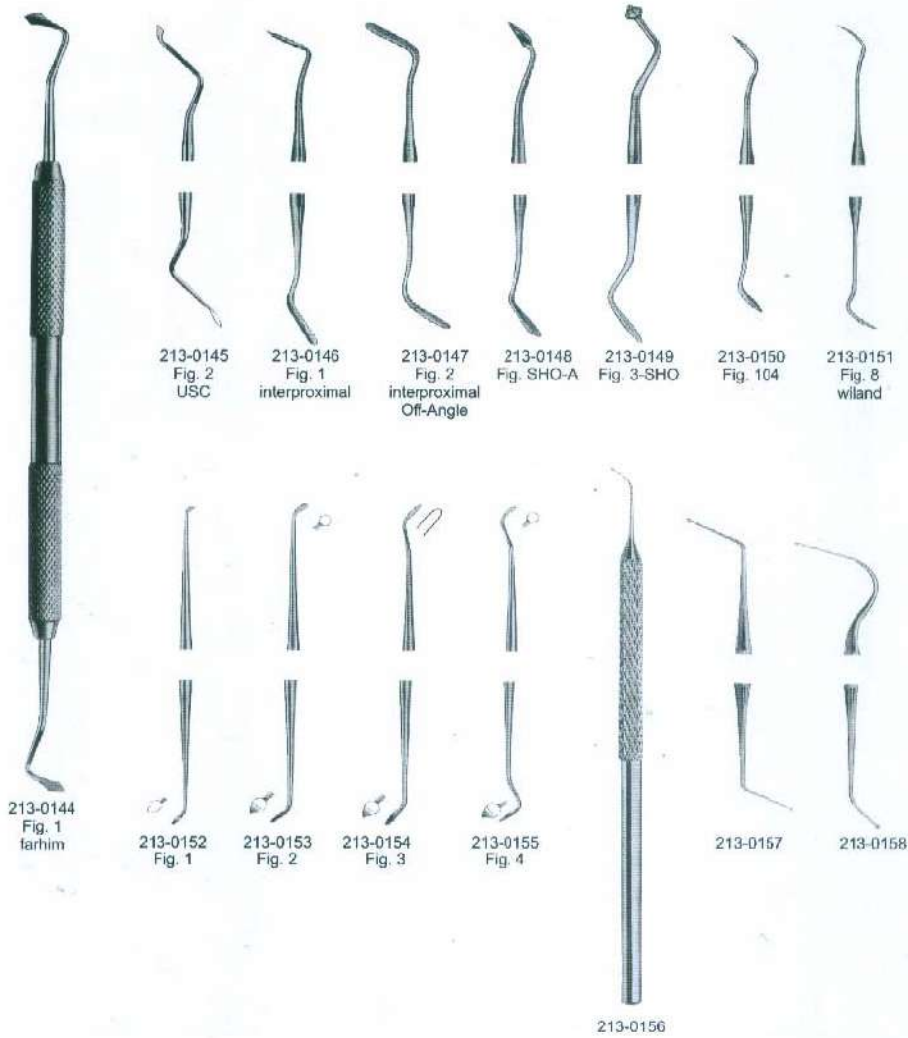

Web: [www.mabsonortho.com](http://www.mabsonortho.com)

Tel: +92 52 3570603  
Fax: +92 52 3570604  
Moh. Islamabad Union Council  
Near Imran Market Ugoki Morre,  
Sialkot-51310 Pakistan.



MABSON ORTHO

# MABSON INDUSTRY

Manufacturer & Exporter of Surgical, Dental & Orthopedic Instruments

## Cavity Preparation Instruments

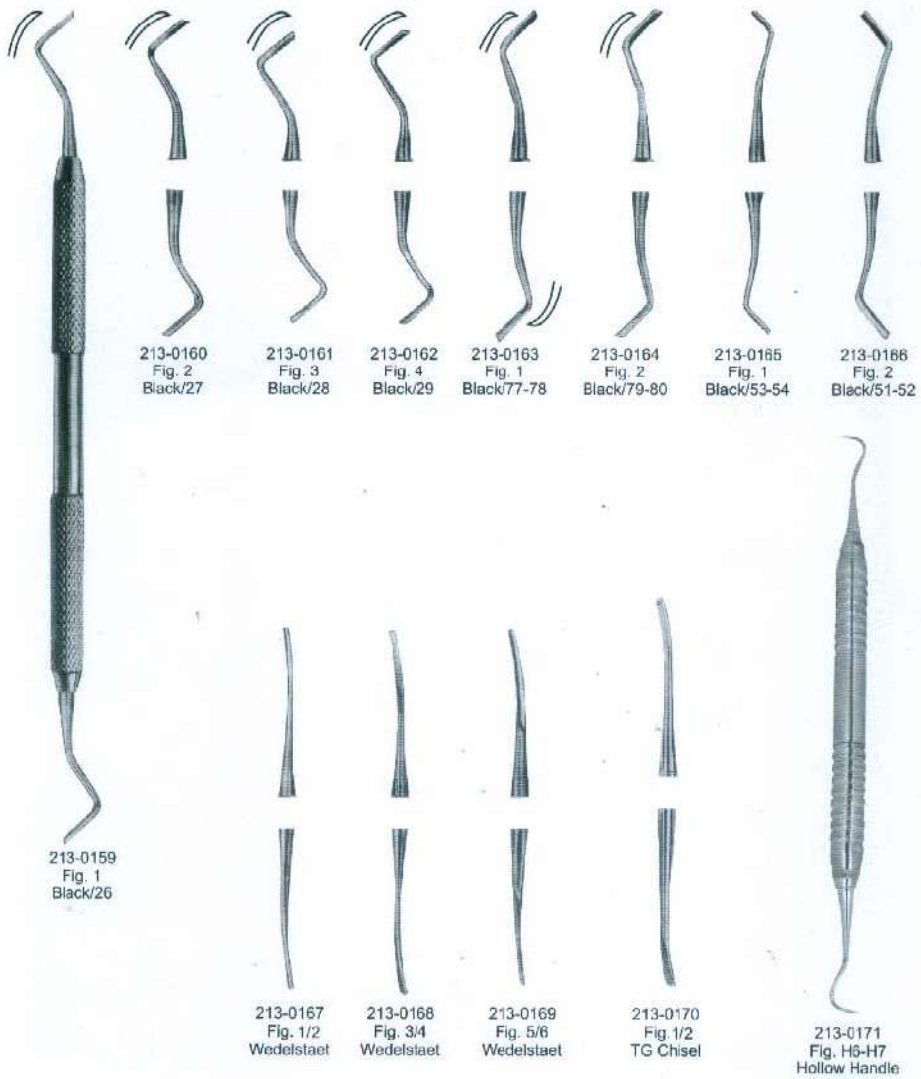

Web: [www.mabsonortho.com](http://www.mabsonortho.com)

Tel: +92 52 3570603  
Fax: +92 52 3570604  
Moh. Islamabad Union Council  
Near Imran Market Ugoki Morre,  
Sialkot-51310 Pakistan.



MABSON ORTHO

# MABSON INDUSTRY

Manufacturer & Exporter of Surgical, Dental & Orthopedic Instruments

## Excavators

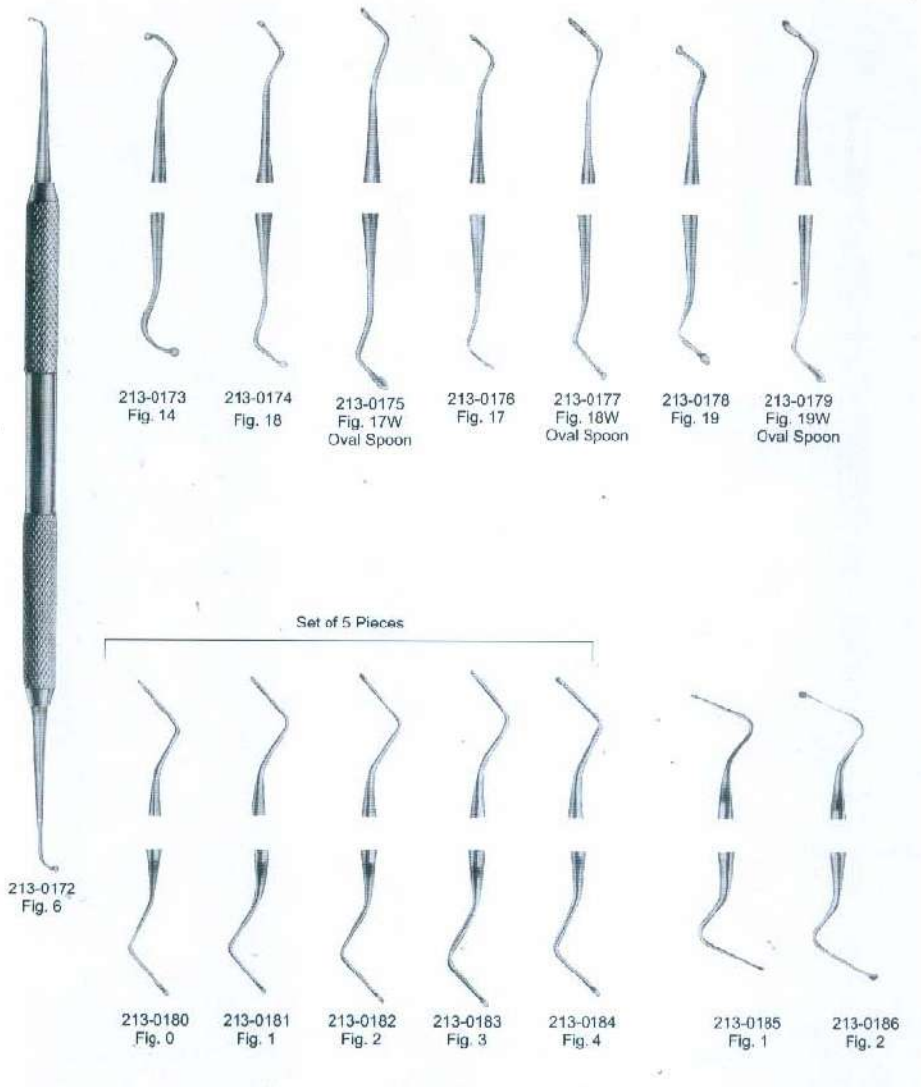

Web: [www.mabsonortho.com](http://www.mabsonortho.com)

Tel: +92 52 3570603  
Fax: +92 52 3570604  
Moh. Islamabad Union Council  
Near Imran Market Ugoki Morre,  
Sialkot-51310 Pakistan.



MABSON ORTHO

# MABSON INDUSTRY

Manufacturer & Exporter of Surgical, Dental & Orthopedic Instruments

## Excavators

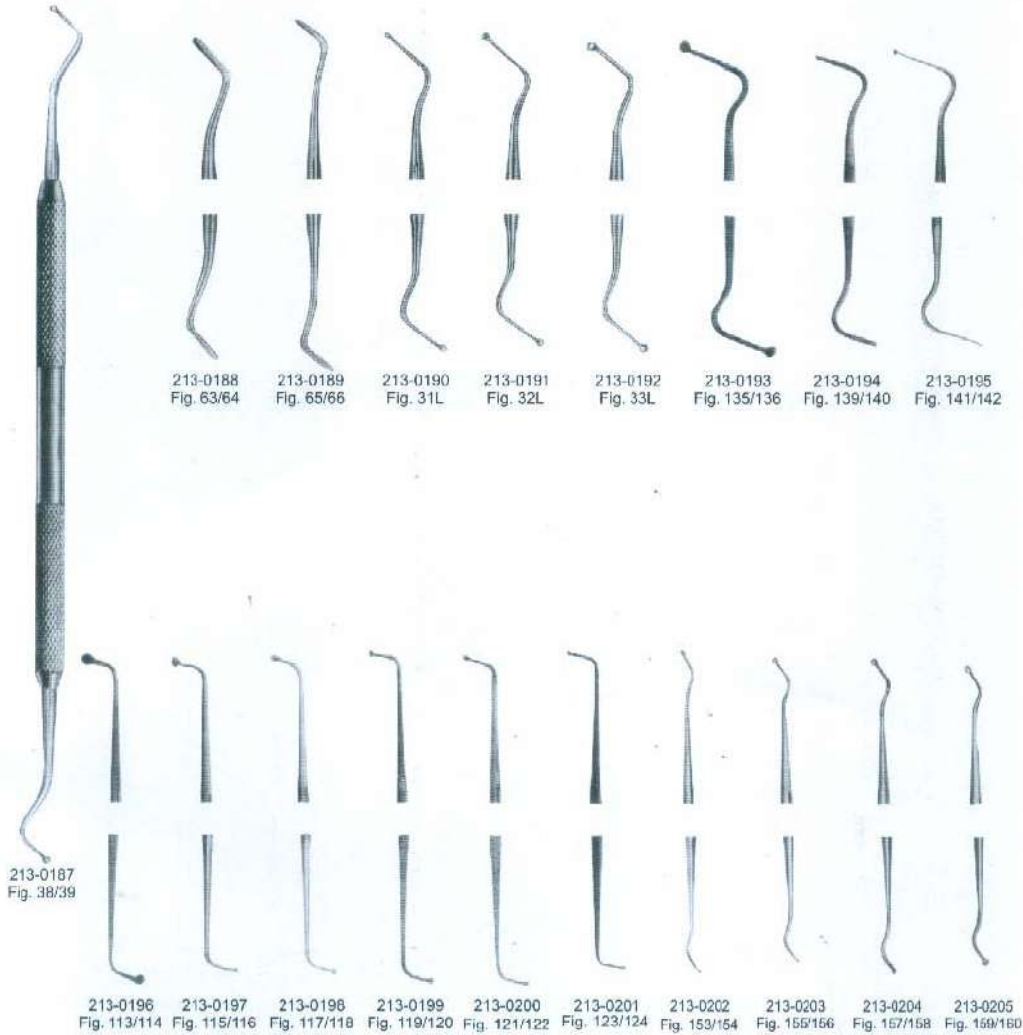

Web: [www.mabsonortho.com](http://www.mabsonortho.com)

Tel: +92 52 3570603  
Fax: +92 52 3570604  
Moh. Islamabad Union Council  
Near Imran Market Ugoki Morre,  
Sialkot-51310 Pakistan.





MABSON ORTHO

# MABSON INDUSTRY

Manufacturer & Exporter of Surgical, Dental & Orthopedic Instruments

## Excavators English Pattern

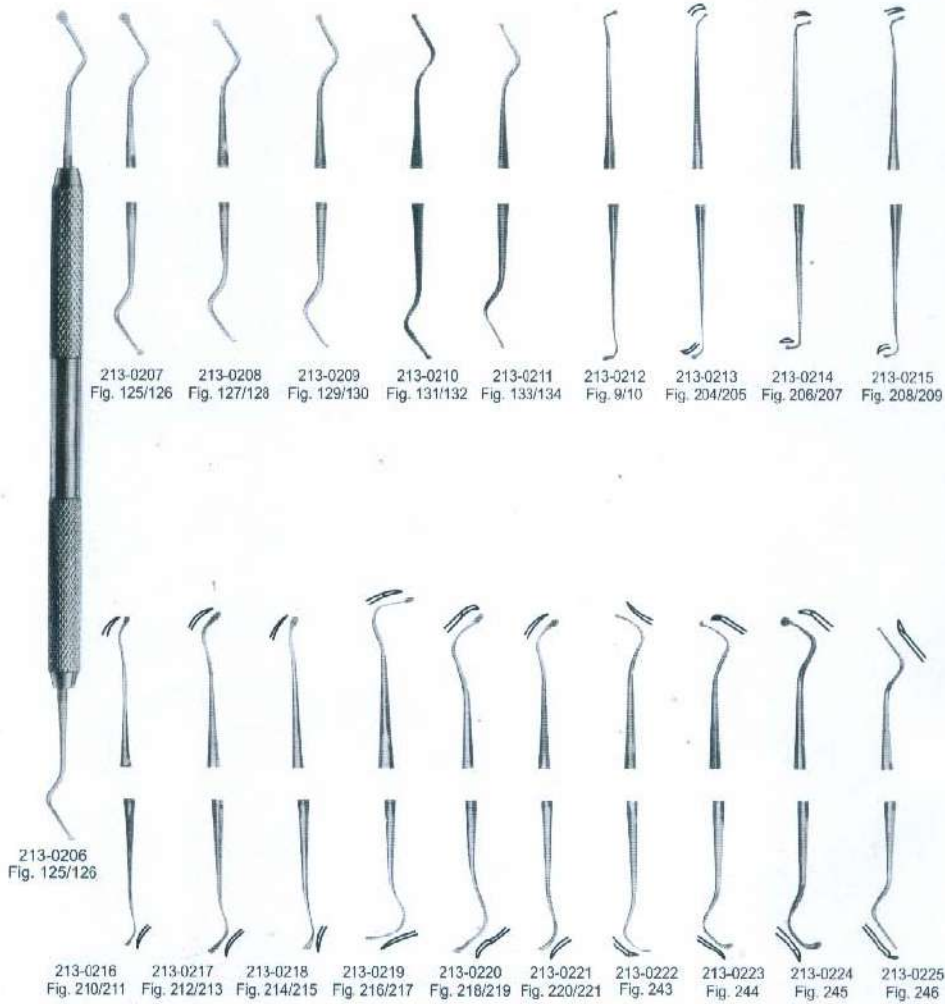

Web: [www.mabsonortho.com](http://www.mabsonortho.com)

Tel: +92 52 3570603  
Fax: +92 52 3570604  
Moh. Islamabad Union Council  
Near Imran Market Ugoki Morre,  
Sialkot-51310 Pakistan.



MABSON ORTHO

**MABSON  
INDUSTRY**

Manufacturer & Exporter of Surgical, Dental & Orthopedic Instruments

## Periodontia Instruments

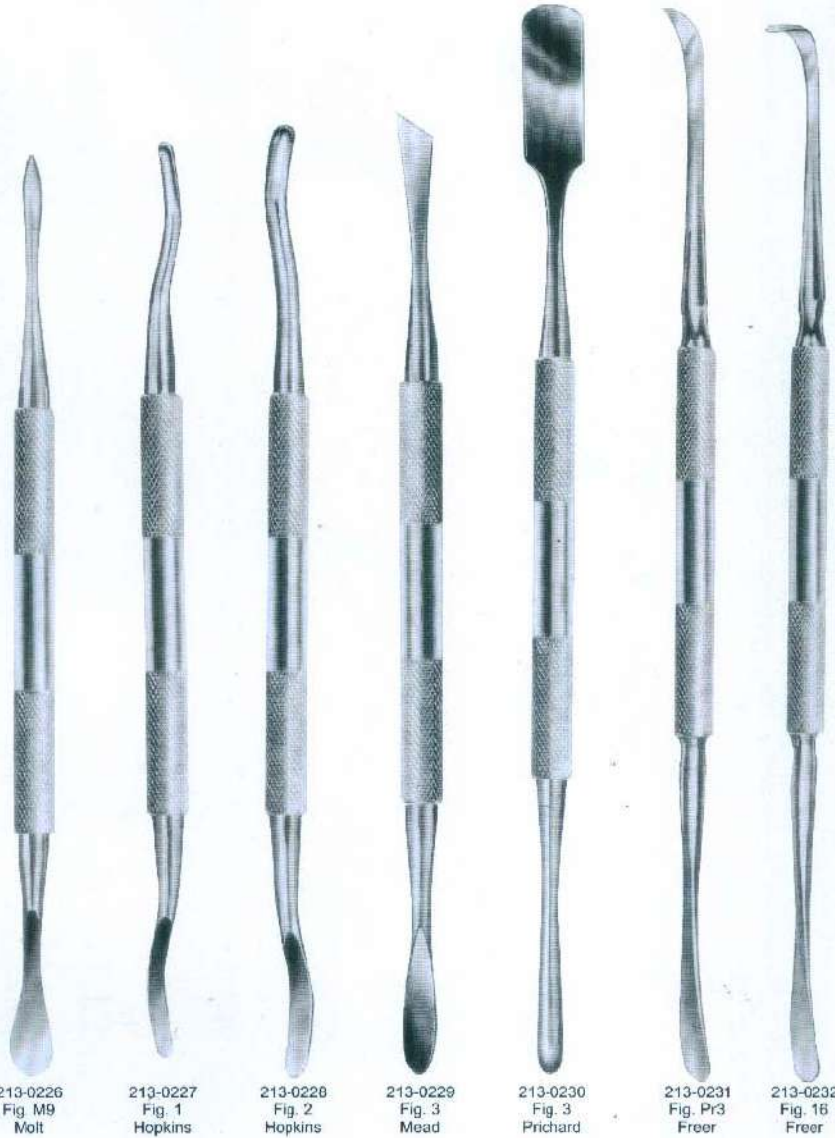

213-0226  
Fig. M9  
Molt

213-0227  
Fig. 1  
Hopkins

213-0228  
Fig. 2  
Hopkins

213-0229  
Fig. 3  
Mead

213-0230  
Fig. 3  
Prichard

213-0231  
Fig. Pr3  
Freer

213-0232  
Fig. 16  
Freer

Web: [www.mabsonortho.com](http://www.mabsonortho.com)

Tel: +92 52 3570603  
Fax: +92 52 3570604  
Moh. Islamabad Union Council  
Near Imran Market Ugoki Morre,  
Sialkot-51310 Pakistan.



MABSON ORTHO

**MABSON  
INDUSTRY**

Manufacturer & Exporter of Surgical, Dental & Orthopedic Instruments

**Bone Files**

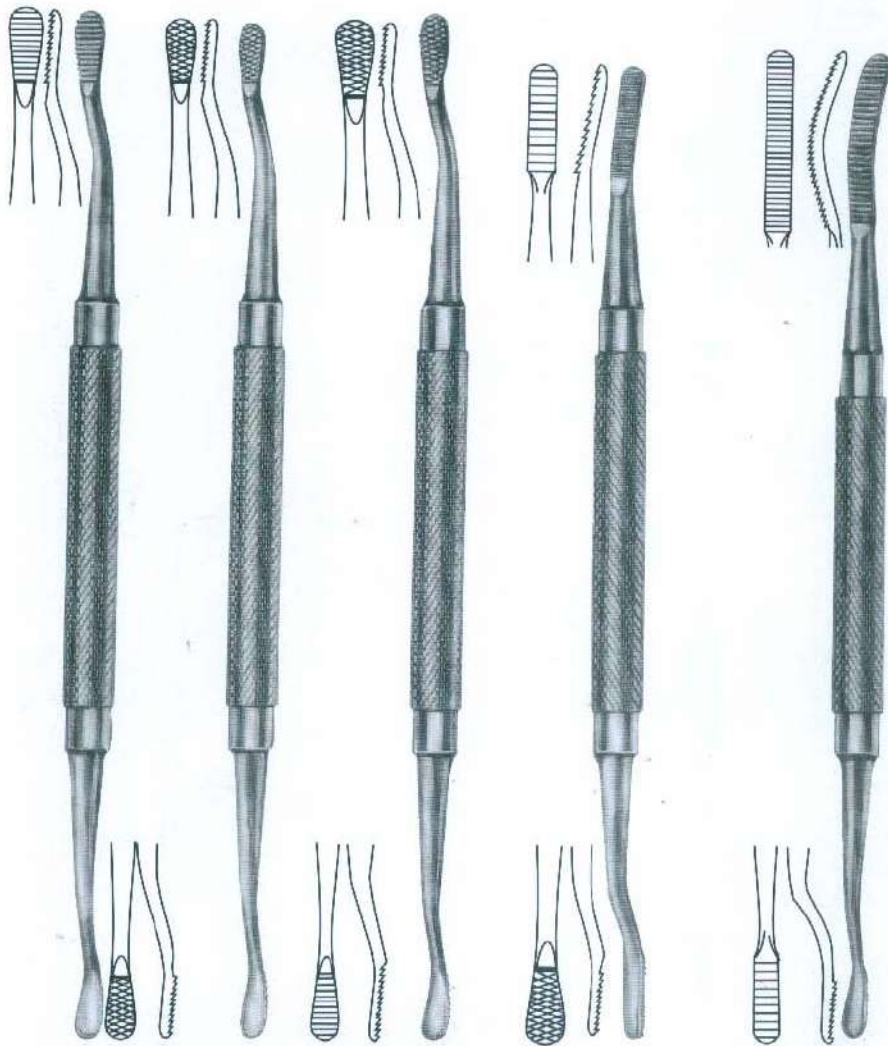

213-0233  
Fig. 12 CA

213-0234  
Fig. 12A

213-0235  
Fig. 12  
Howard

213-0236  
Fig. 33

213-0237  
Fig. 45  
Miller

Web: [www.mabsonortho.com](http://www.mabsonortho.com)

Tel: +92 52 3570603  
Fax: +92 52 3570604  
Moh. Islamabad Union Council  
Near Imran Market Ugoki Morre,  
Sialkot-51310 Pakistan.



MABSON ORTHO

# MABSON INDUSTRY

Manufacturer & Exporter of Surgical, Dental & Orthopedic Instruments

## Bone Files

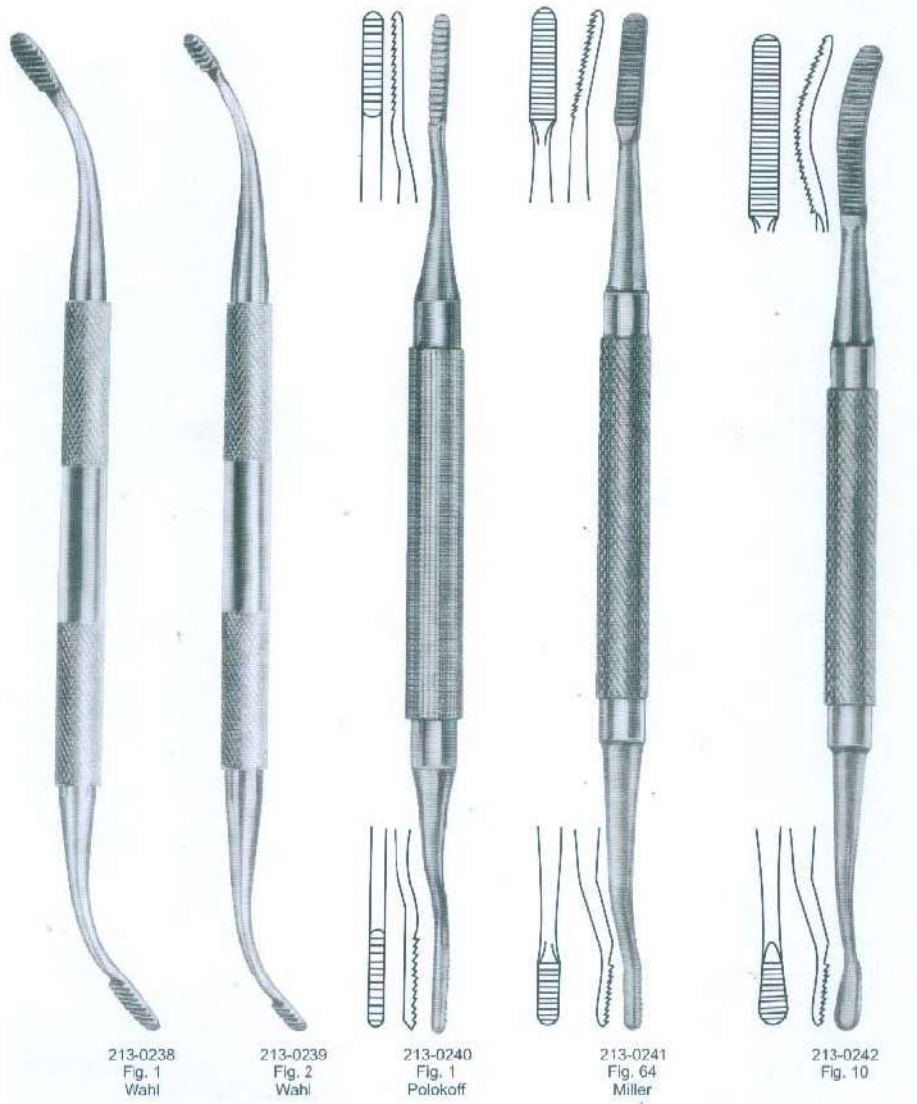

213-0238  
Fig. 1  
Wahl

213-0239  
Fig. 2  
Wahl

213-0240  
Fig. 1  
Polokoff

213-0241  
Fig. 64  
Miller

213-0242  
Fig. 10

Web: [www.mabsonortho.com](http://www.mabsonortho.com)

Tel: +92 52 3570603  
Fax: +92 52 3570604  
Moh. Islamabad Union Council  
Near Imran Market Ugoki Morre,  
Sialkot-51310 Pakistan.



MABSON ORTHO

# MABSON INDUSTRY

Manufacturer & Exporter of Surgical, Dental & Orthopedic Instruments

## Bone Curettes periodontia instruments

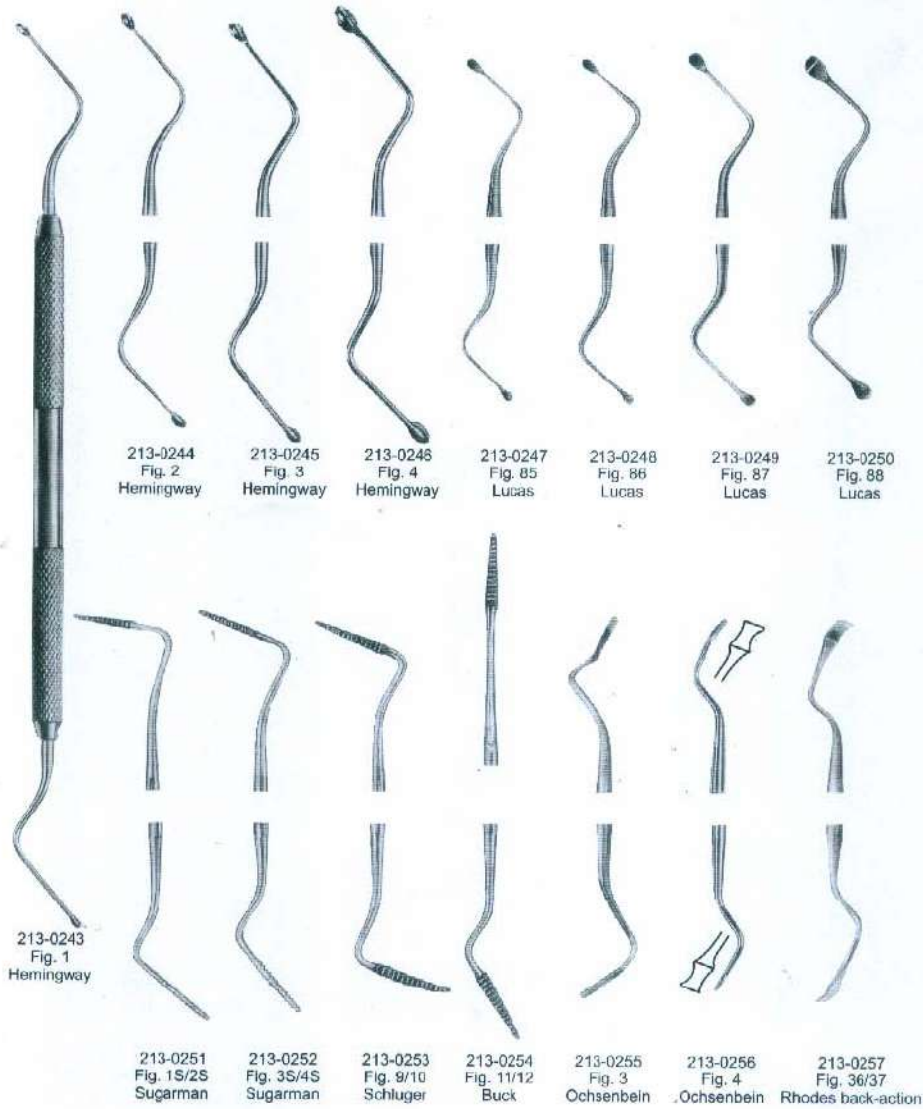

Web: [www.mabsonortho.com](http://www.mabsonortho.com)

Tel: +92 52 3570603  
Fax: +92 52 3570604  
Moh. Islamabad Union Council  
Near Imran Market Ugoki Morre,  
Sialkot-51310 Pakistan.



MABSON ORTHO

# MABSON INDUSTRY

Manufacturer & Exporter of Surgical, Dental & Orthopedic Instruments

## Periodontia Instruments

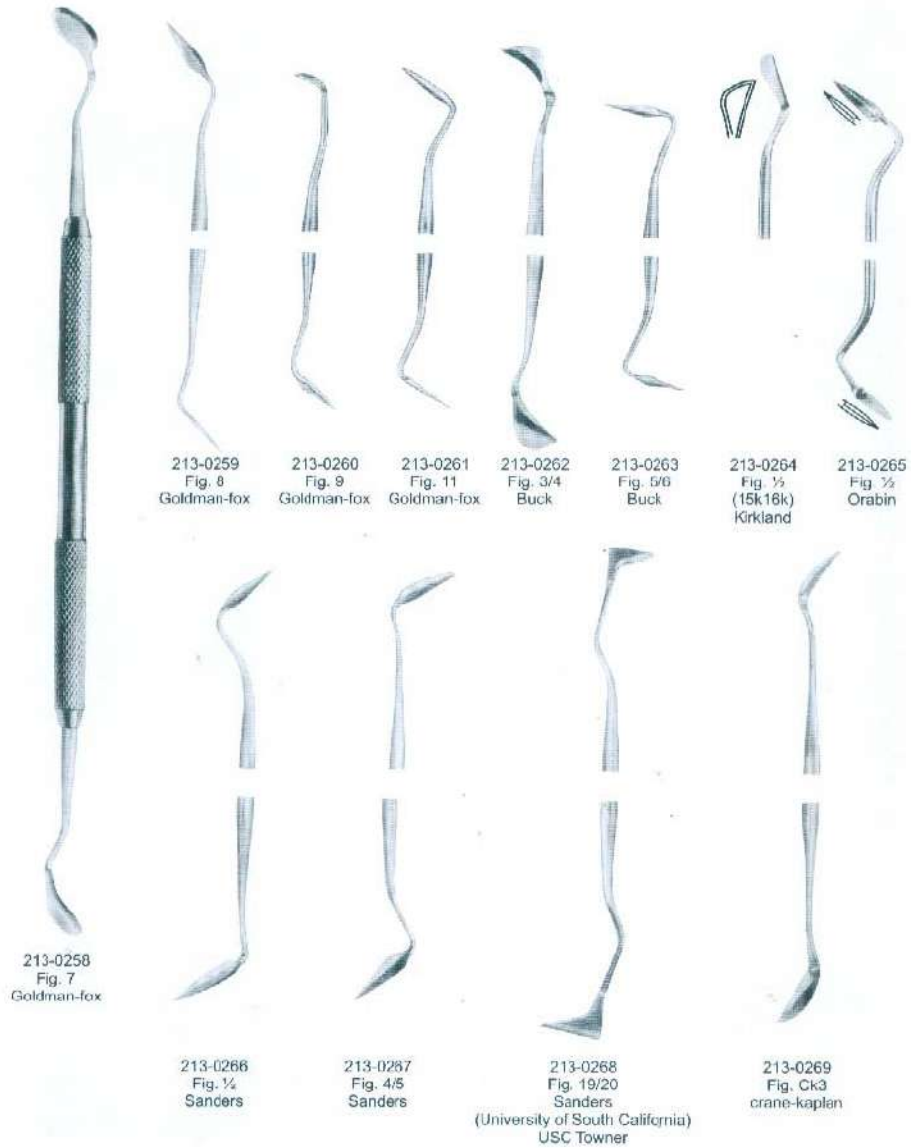

Web: [www.mabsonortho.com](http://www.mabsonortho.com)

Tel: +92 52 3570603  
Fax: +92 52 3570604  
Moh. Islamabad Union Council  
Near Imran Market Ugoki Morre,  
Sialkot-51310 Pakistan.



MABSON ORTHO

# MABSON INDUSTRY

Manufacturer & Exporter of Surgical, Dental & Orthopedic Instruments

## Periodontia Instruments

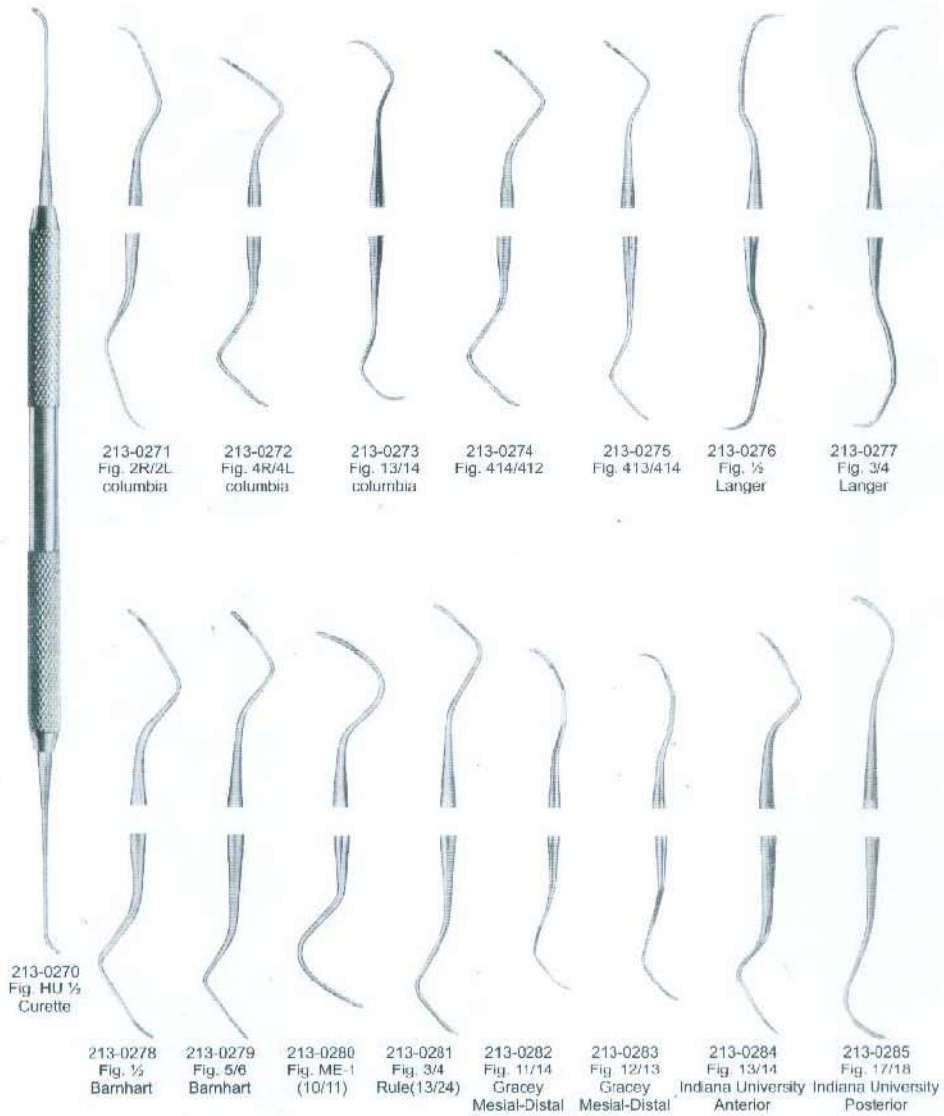

Web: [www.mabsonortho.com](http://www.mabsonortho.com)

Tel: +92 52 3570603  
Fax: +92 52 3570604  
Moh. Islamabad Union Council  
Near Imran Market Ugoki Morre,  
Sialkot-51310 Pakistan.



MABSON ORTHO

**MABSON  
INDUSTRY**

Manufacturer & Exporter of Surgical, Dental & Orthopedic Instruments

**Periodontia Instruments  
Gracey Curettes**

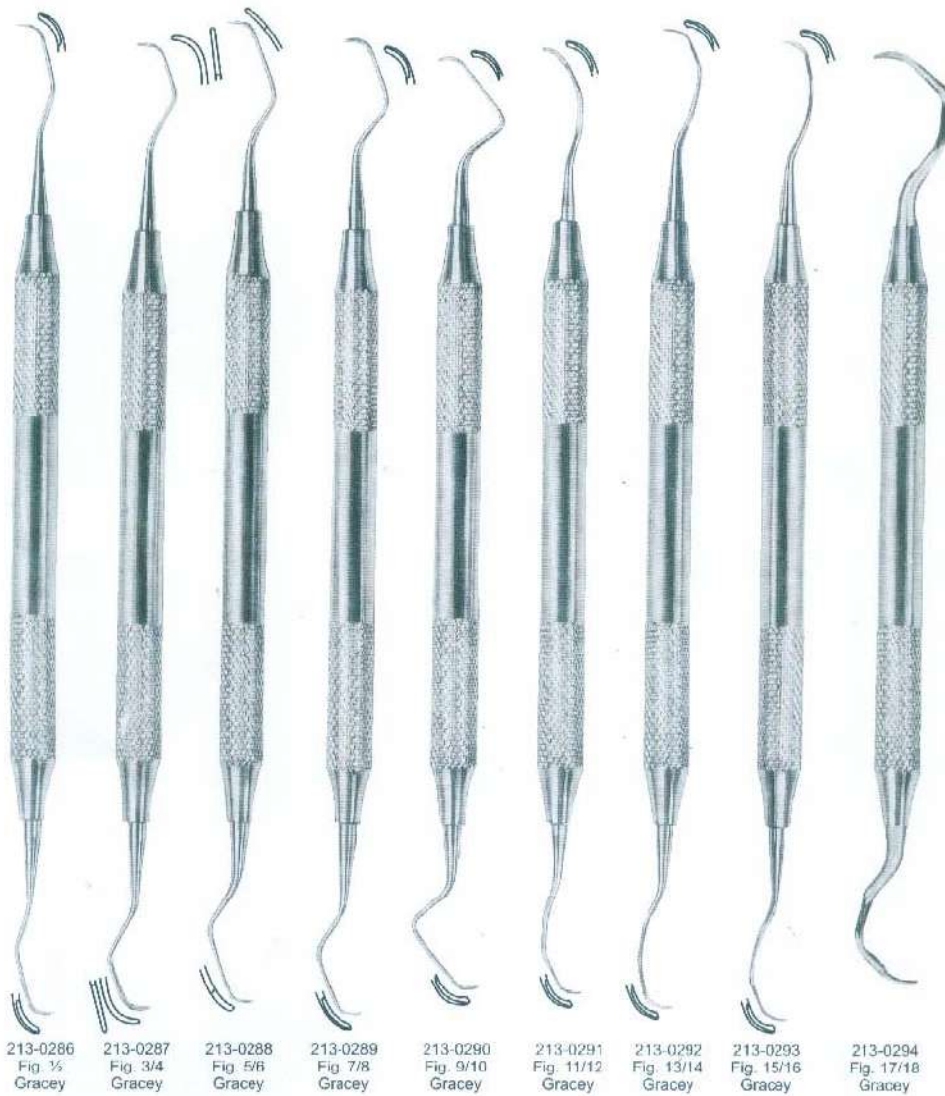

Web: [www.mabsonortho.com](http://www.mabsonortho.com)

Tel: +92 52 3570603  
Fax: +92 52 3570604  
Moh. Islamabad Union Council  
Near Imran Market Ugoki Morre,  
Sialkot-51310 Pakistan.





MABSON ORTHO

# MABSON INDUSTRY

Manufacturer & Exporter of Surgical, Dental & Orthopedic Instruments

## Periodontia Instruments

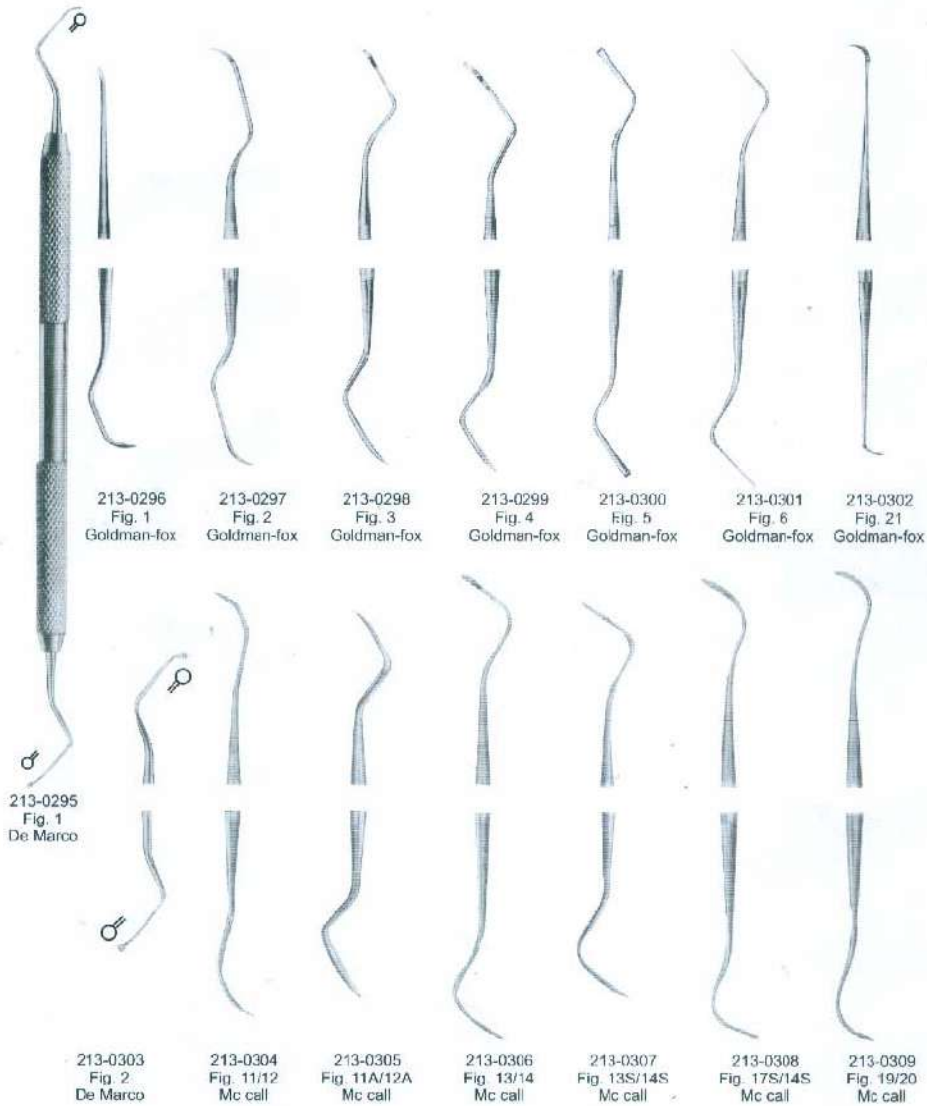

Web: [www.mabsonortho.com](http://www.mabsonortho.com)

Tel: +92 52 3570603  
Fax: +92 52 3570604  
Moh. Islamabad Union Council  
Near Imran Market Ugoki Morre,  
Sialkot-51310 Pakistan.



MABSON ORTHO

# MABSON INDUSTRY

Manufacturer & Exporter of Surgical, Dental & Orthopedic Instruments

## peridontia Instruments Scalers

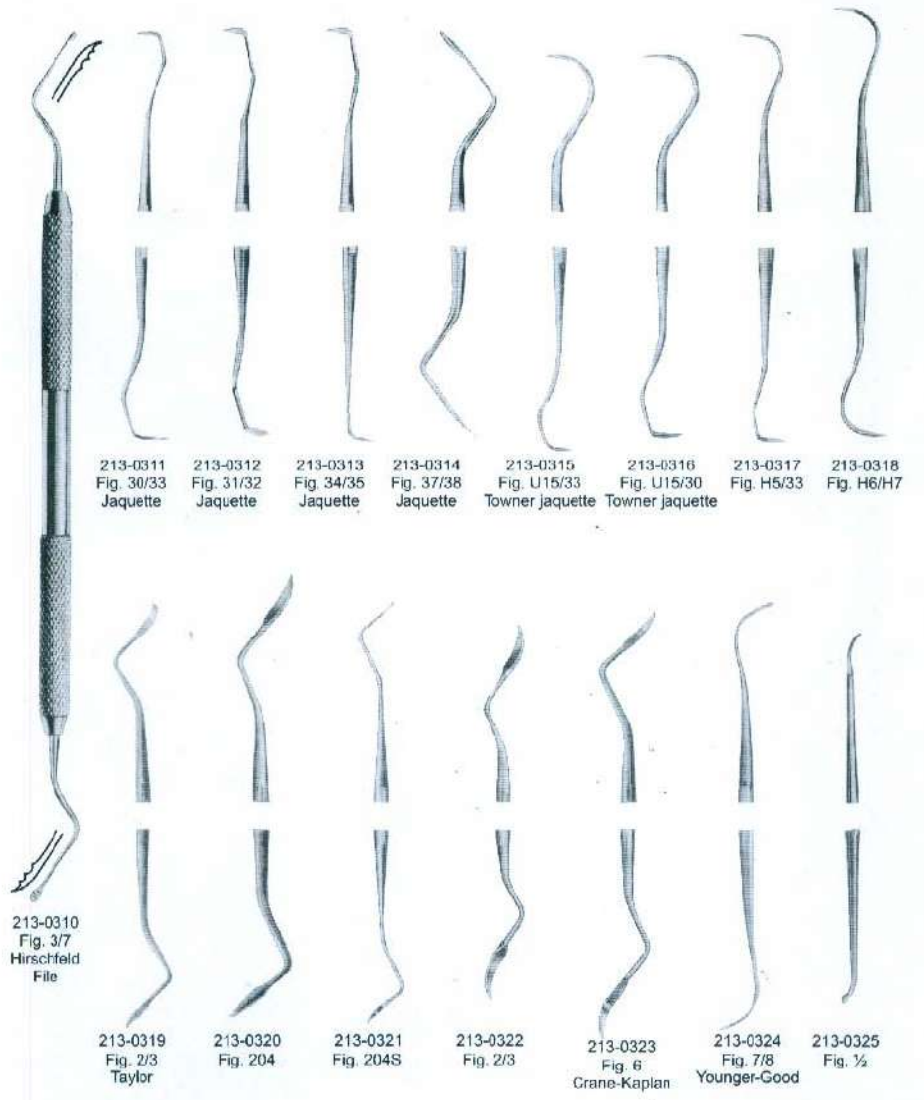

Web: [www.mabsonortho.com](http://www.mabsonortho.com)

Tel: +92 52 3570603  
Fax: +92 52 3570604  
Moh. Islamabad Union Council  
Near Imran Market Ugoki Morre,  
Sialkot-51310 Pakistan.



MABSON ORTHO

# MABSON INDUSTRY

Manufacturer & Exporter of Surgical, Dental & Orthopedic Instruments

## peridontia Instruments Scalers

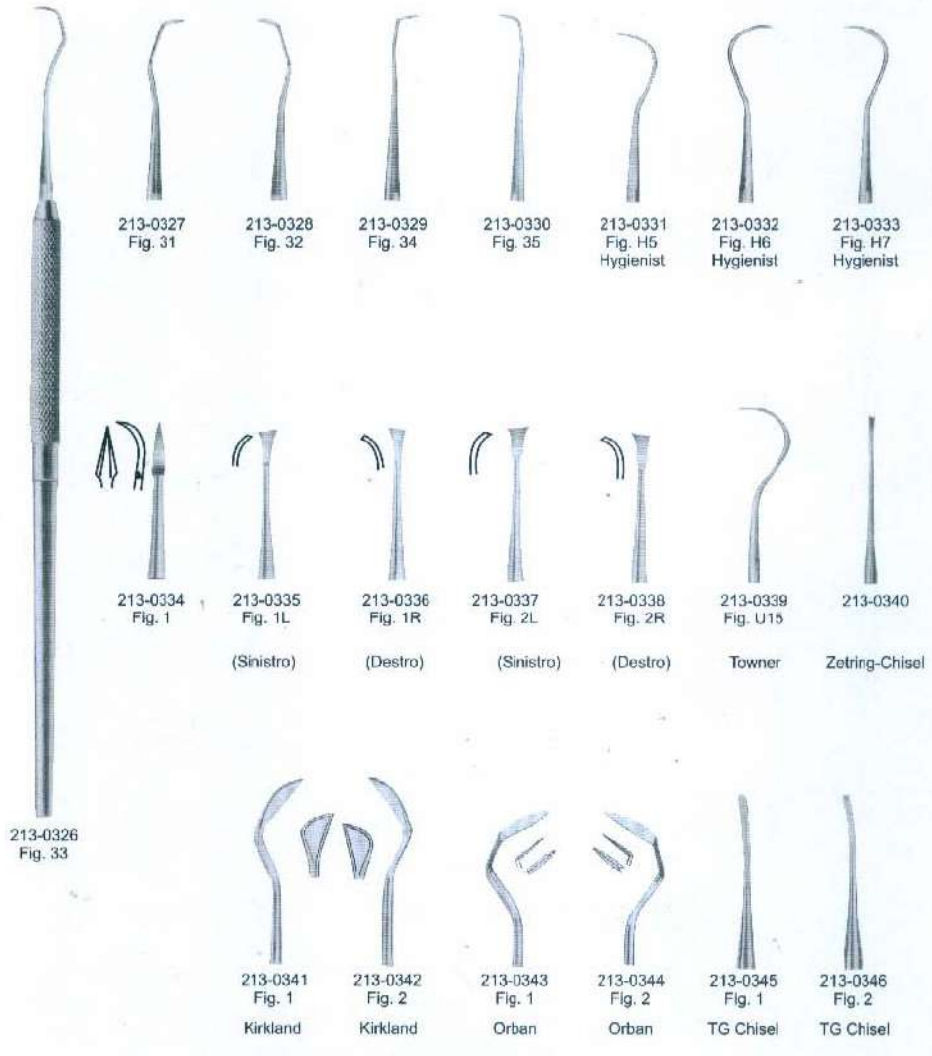

Web: [www.mabsonortho.com](http://www.mabsonortho.com)

Tel: +92 52 3570603  
Fax: +92 52 3570604  
Moh. Islamabad Union Council  
Near Imran Market Ugoki Morre,  
Sialkot-51310 Pakistan.



MABSON ORTHO

**MABSON  
INDUSTRY**

Manufacturer & Exporter of Surgical, Dental & Orthopedic Instruments

**Cement spatulas  
heidemann separating  
spatulas**

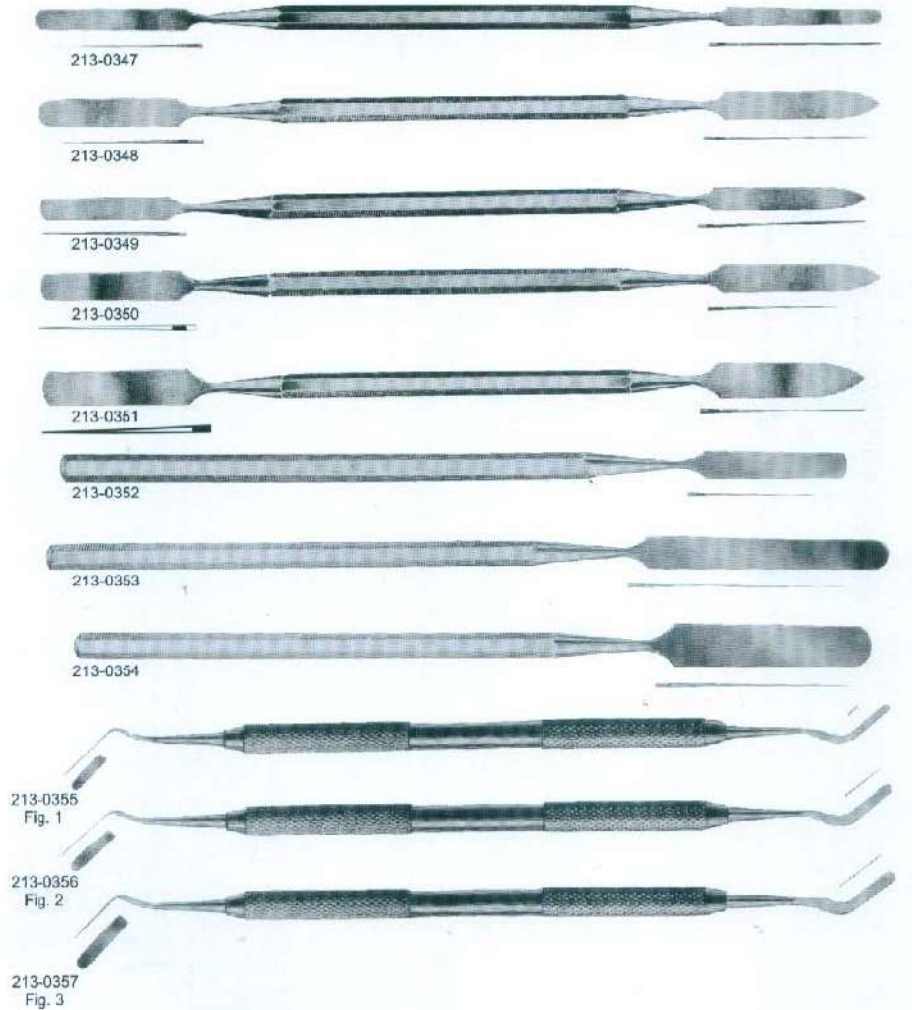

Web: [www.mabsonortho.com](http://www.mabsonortho.com)

Tel: +92 52 3570603  
Fax: +92 52 3570604  
Moh. Islamabad Union Council  
Near Imran Market Ugoki Morre,  
Sialkot-51310 Pakistan.



MABSON ORTHO

# MABSON INDUSTRY

Manufacturer & Exporter of Surgical, Dental & Orthopedic Instruments

## Wax and Modelling Carvers

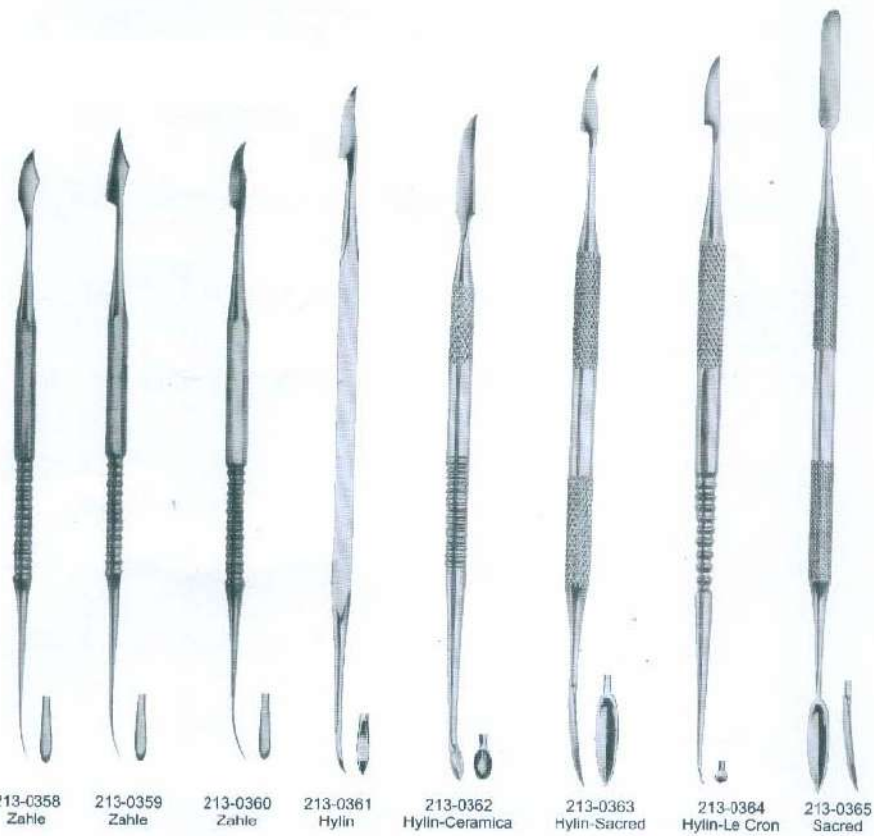

213-0358  
Zahle

213-0359  
Zahle

213-0360  
Zahle

213-0361  
Hylin

213-0362  
Hylin-Ceramica

213-0363  
Hylin-Sacred

213-0364  
Hylin-Le Cron

213-0365  
Sacred

Web: [www.mabsonortho.com](http://www.mabsonortho.com)

Tel: +92 52 3570603  
Fax: +92 52 3570604  
Moh. Islamabad Union Council  
Near Imran Market Ugoki Morre,  
Sialkot-51310 Pakistan.



MABSON ORTHO

**MABSON  
INDUSTRY**

Manufacturer & Exporter of Surgical, Dental & Orthopedic Instruments

**Wax and Modelling  
Carvers**

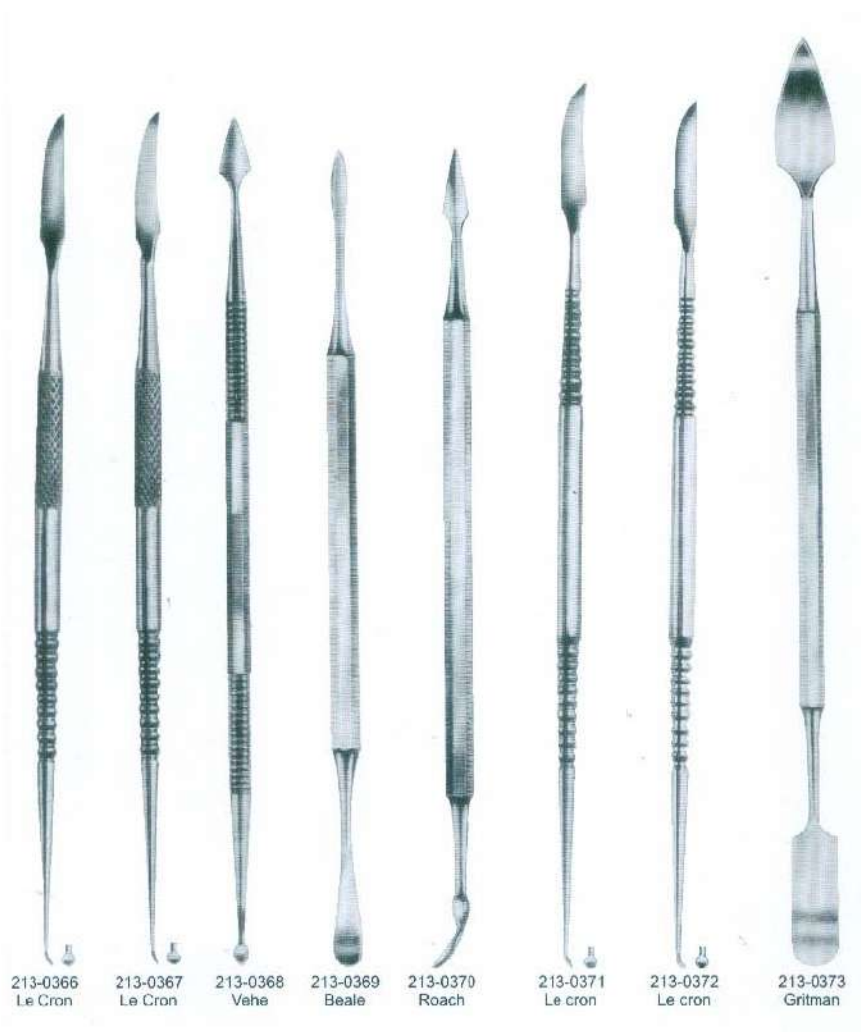

Web: [www.mabsonortho.com](http://www.mabsonortho.com)

Tel: +92 52 3570603  
Fax: +92 52 3570604  
Moh. Islamabad Union Council  
Near Imran Market Ugoki Morre,  
Sialkot-51310 Pakistan.



MABSON ORTHO

**MABSON  
INDUSTRY**

Manufacturer & Exporter of Surgical, Dental & Orthopedic Instruments

**Wax and Modelling  
Carvers**



213-0374  
Fig. 1  
P. K.thomas



213-0375  
Fig. 2  
P. K.thomas



213-0376  
Fig. 3  
P. K.thomas



213-0377  
Fig. 4  
P. K.thomas



213-0378  
Fig. 5  
P. K.thomas

Web: [www.mabsonortho.com](http://www.mabsonortho.com)

Tel: +92 52 3570603  
Fax: +92 52 3570604  
Moh. Islamabad Union Council  
Near Imran Market Ugoki Morre,  
Sialkot-51310 Pakistan.



MABSON ORTHO

**MABSON  
INDUSTRY**

Manufacturer & Exporter of Surgical, Dental & Orthopedic Instruments

**Wax Knives**



214-0001  
Fig. 1  
Fahnenstock  
12.5 cm

214-0002  
Fig. 1  
Lessmann  
12.5 cm

214-0003  
Fig. 1  
Con Scodellina

214-0004  
Fig. 2  
Fahnenstock

214-0005  
Fig. 2  
Lessmann

214-0006  
Fig. 2  
Con Scodellina

Web: [www.mabsonortho.com](http://www.mabsonortho.com)

Tel: +92 52 3570603  
Fax: +92 52 3570604  
Moh. Islamabad Union Council  
Near Imran Market Ugoki Morre,  
Sialkot-51310 Pakistan.





MABSON ORTHO

**MABSON  
INDUSTRY**

Manufacturer & Exporter of Surgical, Dental & Orthopedic Instruments

**Spatulas for plaster  
and alginate**



214-0007  
cm 17



214-0008  
cm 17 Gritman



214-0009  
cm 19.5



214-0010  
cm 21.5



214-0011  
cm 20.5



214-0012  
cm 19.5



214-0013  
cm 20



214-0014  
cm 22.5

Web: [www.mabsonortho.com](http://www.mabsonortho.com)

Tel: +92 52 3570603  
Fax: +92 52 3570604  
Moh. Islamabad Union Council  
Near Imran Market Ugoki Morre,  
Sialkot-51310 Pakistan.



MABSON ORTHO

# MABSON INDUSTRY

Manufacturer & Exporter of Surgical, Dental & Orthopedic Instruments

## Amalgam Carriers

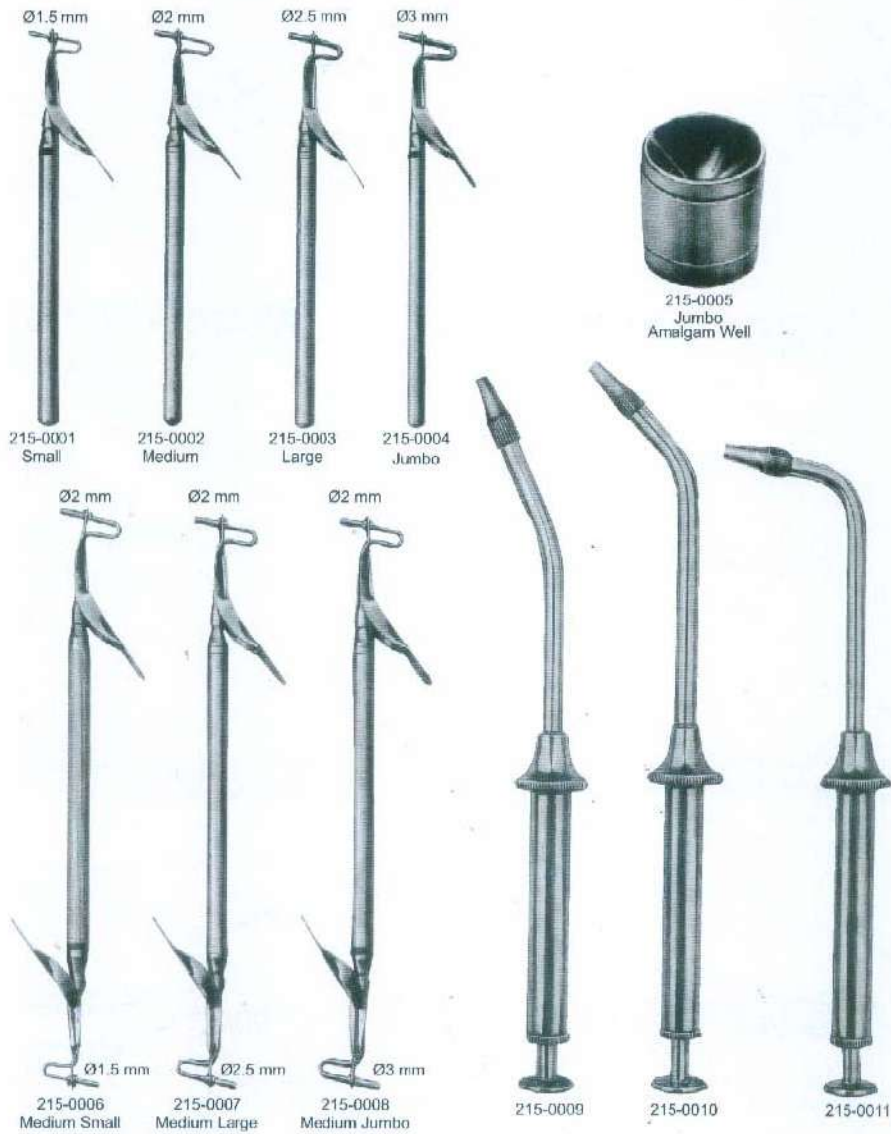

Web: [www.mabsonortho.com](http://www.mabsonortho.com)

Tel: +92 52 3570603  
Fax: +92 52 3570604  
Moh. Islamabad Union Council  
Near Imran Market Ugoki Morre,  
Sialkot-51310 Pakistan.



MABSON ORTHO

**MABSON  
INDUSTRY**

Manufacturer & Exporter of Surgical, Dental & Orthopedic Instruments

## Dental Cartridge Syringes



215-0012



215-0013



215-0014



215-0015



215-0016



215-0017



215-0018



215-0019



215-0020



215-0021

Web: [www.mabsonortho.com](http://www.mabsonortho.com)

Tel: +92 52 3570603  
Fax: +92 52 3570604  
Moh. Islamabad Union Council  
Near Imran Market Ugoki Morre,  
Sialkot-51310 Pakistan.



MABSON ORTHO

**MABSON  
INDUSTRY**

Manufacturer & Exporter of Surgical, Dental & Orthopedic Instruments

## Dental Cartridge Syringes

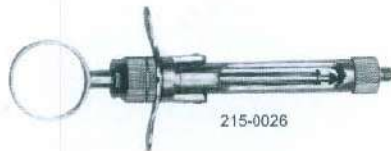

Web: [www.mabsonortho.com](http://www.mabsonortho.com)

Tel: +92 52 3570603  
Fax: +92 52 3570604  
Moh. Islamabad Union Council  
Near Imran Market Ugoki Morre,  
Sialkot-51310 Pakistan.



MABSON ORTHO

# MABSON INDUSTRY

Manufacturer & Exporter of Surgical, Dental & Orthopedic Instruments

**Chip Blowers, Water Syringes  
Napkin Holder  
Film Holder**



Chip blower



215-0032



215-0033



215-0034

215-0035  
For 6 Films  
215-0036  
For 10 Films  
215-0037  
For 14 Films



Films Holder



215-0038  
Water Syringe



215-0039  
Water Syringe



215-0040  
Napkin holder with plastic band

215-0041  
Napkin holder with metal chain

Web: [www.mabsonortho.com](http://www.mabsonortho.com)

Tel: +92 52 3570603  
Fax: +92 52 3570604  
Moh. Islamabad Union Council  
Near Imran Market Ugoki Morre,  
Sialkot-51310 Pakistan.



MABSON ORTHO

# MABSON INDUSTRY

Manufacturer & Exporter of Surgical, Dental & Orthopedic Instruments

## Matrix Retainers

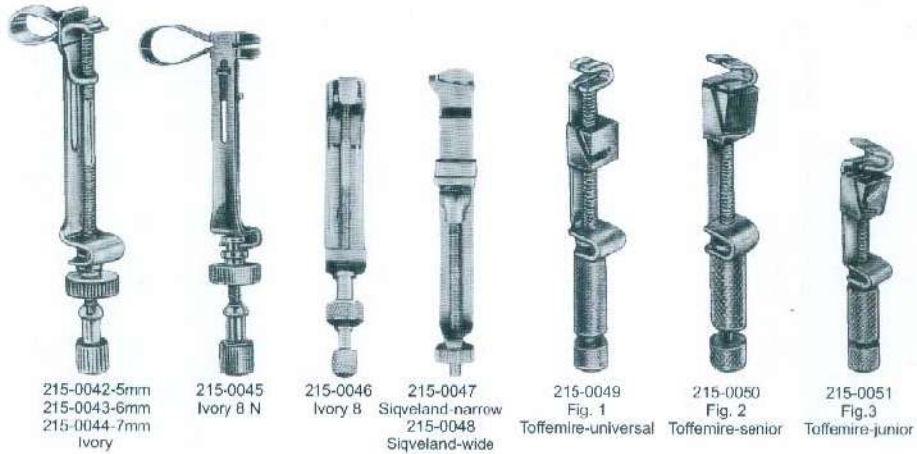

Web: [www.mabsonortho.com](http://www.mabsonortho.com)

Tel: +92 52 3570603  
Fax: +92 52 3570604  
Moh. Islamabad Union Council  
Near Imran Market Ugoki Morre,  
Sialkot-51310 Pakistan.



MABSON ORTHO

# MABSON INDUSTRY

Manufacturer & Exporter of Surgical, Dental & Orthopedic Instruments

## Crown Instruments

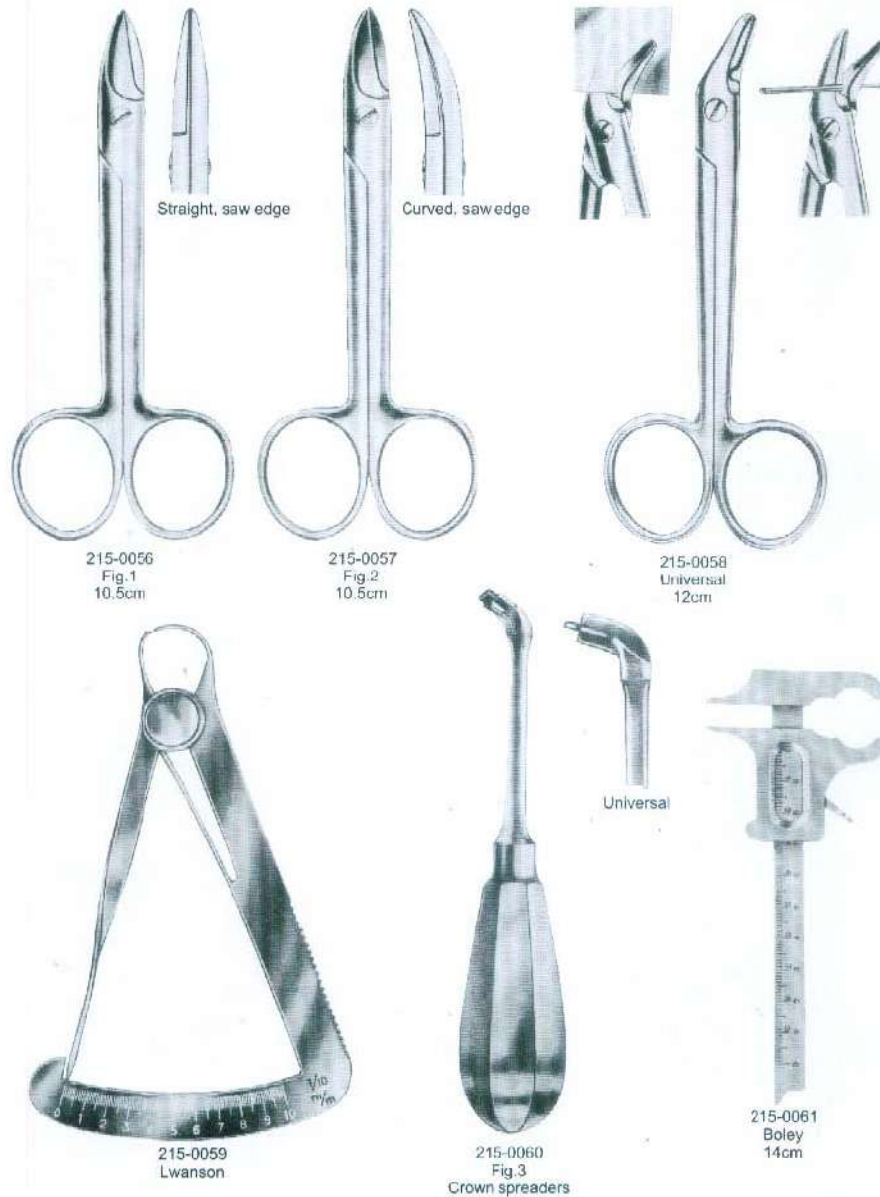

Web: [www.mabsonortho.com](http://www.mabsonortho.com)

Tel: +92 52 3570603  
Fax: +92 52 3570604  
Moh. Islamabad Union Council  
Near Imran Market Ugoki Morre,  
Sialkot-51310 Pakistan.



MABSON ORTHO

# MABSON INDUSTRY

Manufacturer & Exporter of Surgical, Dental & Orthopedic Instruments

## Crown Removers

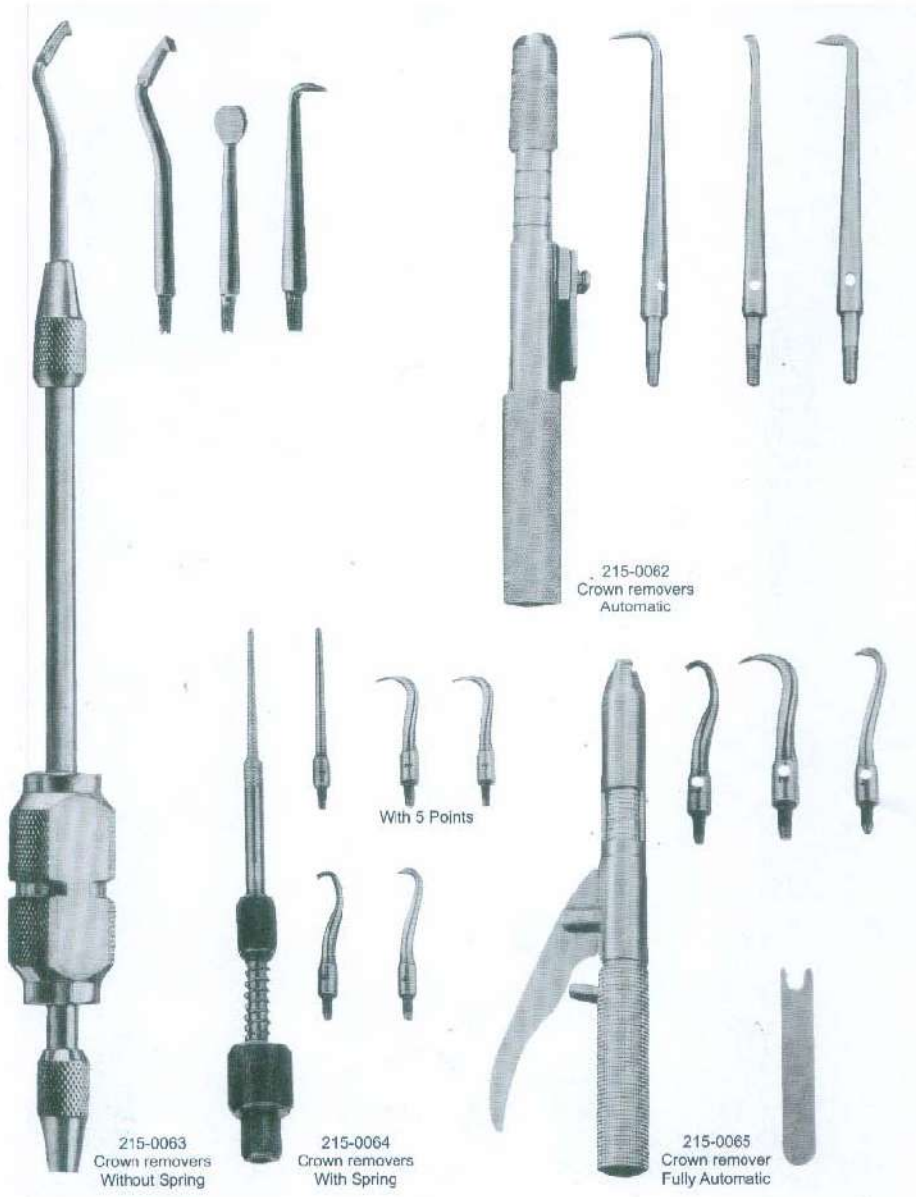

Web: [www.mabsonortho.com](http://www.mabsonortho.com)

Tel: +92 52 3570603  
Fax: +92 52 3570604  
Moh. Islamabad Union Council  
Near Imran Market Ugoki Morre,  
Sialkot-51310 Pakistan.





MABSON ORTHO

# MABSON INDUSTRY

Manufacturer & Exporter of Surgical, Dental & Orthopedic Instruments

## Crown Instruments



215-0066  
Articulating Paper Forcep  
15cm



215-0067  
Miller  
15cm



215-0068  
Crown Spreader



215-0069  
Vernier Gauge Caliper  
0mm to 80mm

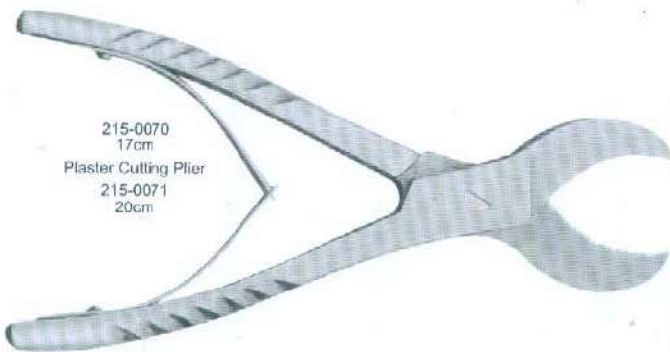

215-0070  
17cm  
Plaster Cutting Plier  
215-0071  
20cm



215-0072  
Arch Turret with 5 wire-slots  
.016", .017", .018", .020" and .022"

Web: [www.mabsonortho.com](http://www.mabsonortho.com)

Tel: +92 52 3570603  
Fax: +92 52 3570604  
Moh. Islamabad Union Council  
Near Imran Market Ugoki Morre,  
Sialkot-51310 Pakistan.



MABSON ORTHO

# MABSON INDUSTRY

Manufacturer & Exporter of Surgical, Dental & Orthopedic Instruments

## Impression Trays

Available in Set of 8  
Code # Set - A001



All the above impression trays are available in these 4 sizes

UPPER		U1	U2	U3	U4	U5
A		62	60	53	54	52
B		63	75	73	69	68

All Dimension are in mm

Lower		L1	L2	L3	L4	L5
A		63	61	57	60	53
B		82	81	78	74	71

All Dimension are in mm

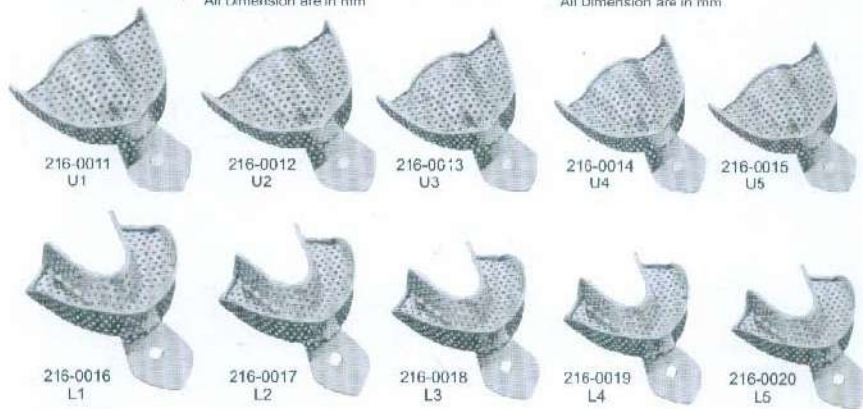

Available in Set of 8  
Code # Set - A002

Web: [www.mabsonortho.com](http://www.mabsonortho.com)

Tel: +92 52 3570603  
Fax: +92 52 3570604  
Moh. Islamabad Union Council  
Near Imran Market Ugoki Morre,  
Sialkot-51310 Pakistan.



**MABSON ORTHO**

# MABSON INDUSTRY

Manufacturer & Exporter of Surgical, Dental & Orthopedic Instruments

## Impression Trays

**Available in Set of 8  
Code # Set - A003**

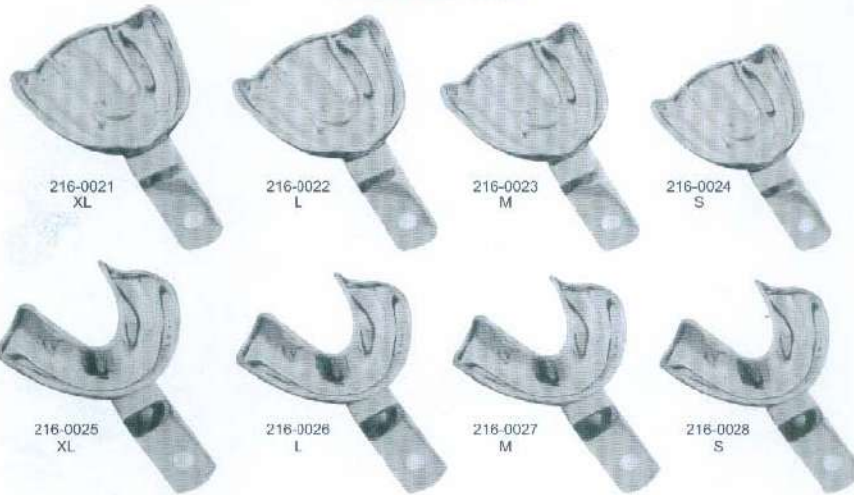

All the above impression trays are available in these 4 sizes

UPPER	All Dimension are in mm			
	XL	L	M	S
A	70	67	64	60
B	79	78	70	73

LOWER	All Dimension are in mm			
	XL	L	M	S
A	64	64	60	57
B	86	70	73	70



**Available in Set of 8  
Code # Set - A004**

Web: [www.mabsonortho.com](http://www.mabsonortho.com)

Tel: +92 52 3570603  
 Fax: +92 52 3570604  
 Moh. Islamabad Union Council  
 Near Imran Market Ugoki Morre,  
 Sialkot-51310 Pakistan.



MABSON ORTHO

# MABSON INDUSTRY

Manufacturer & Exporter of Surgical, Dental & Orthopedic Instruments

## Impression Trays

Available in Set of 6  
Code # Set - A005



216-0037  
U1



216-0038  
U2



216-0039  
U3



216-0040  
L1



216-0041  
L2



216-0042  
L3

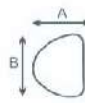

All the above impression trays are available in these 4 sizes

LOWER	All Dimension are in mm		
	L1	L2	L3
A	67	64	57
B	81	71	70

All Dimension are in mm

LOWER	All Dimension are in mm		
	L1	L2	L3
A	60	57	64
B	84	79	76

All Dimension are in mm



216-0043  
U1



216-0044  
U2



216-0045  
U3



216-0046  
L1



216-0047  
L2



216-0048  
L3

Available in Set of 6  
Code # Set - A006

Web: [www.mabsonortho.com](http://www.mabsonortho.com)

Tel: +92 52 3570603  
Fax: +92 52 3570604  
Moh. Islamabad Union Council  
Near Imran Market Ugoki Morre,  
Sialkot-51310 Pakistan.



MABSON ORTHO

# MABSON INDUSTRY

Manufacturer & Exporter of Surgical, Dental & Orthopedic Instruments

## Impression Trays

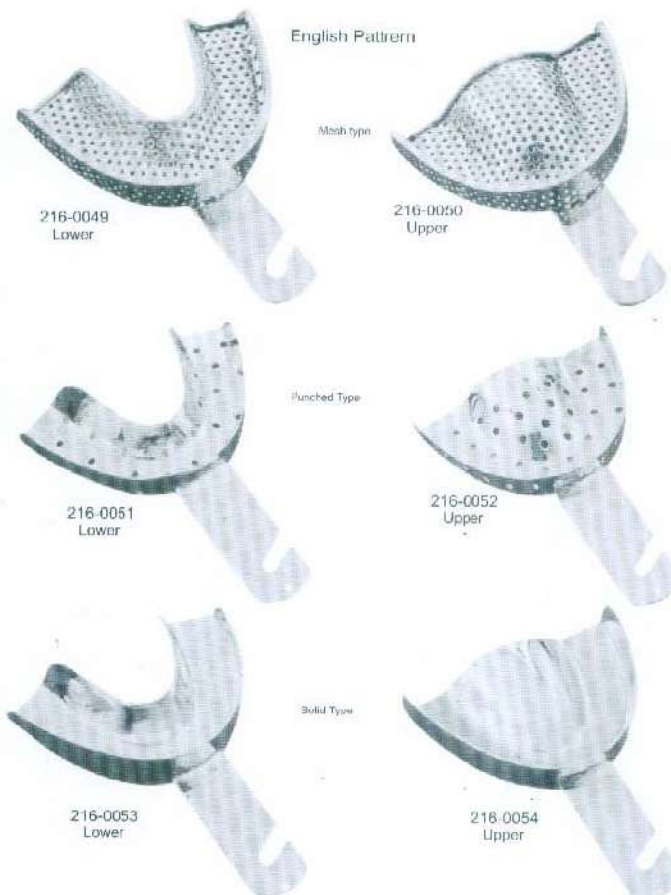

All the above impression trays are available in these 4 sizes

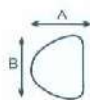

UPPER	Size	A	B	C
	0	67	50	12
1	72	51	13	
2	78	55	15	
3	80	58	15	

All Dimension are in mm

LOWER	Size	A	B	C
	0	70	50	12
1	77	51	13	
2	7	55	15	
3	80	50	15	

All Dimension are in mm

Web: [www.mabsonortho.com](http://www.mabsonortho.com)

Tel: +92 52 3570603  
 Fax: +92 52 3570604  
 Moh. Islamabad Union Council  
 Near Imran Market Ugoki Morre,  
 Sialkot-51310 Pakistan.



MABSON ORTHO

# MABSON INDUSTRY

Manufacturer & Exporter of Surgical, Dental & Orthopedic Instruments

## Impression Trays

Available in Set of 8  
Code # Set - A007



All the above impression trays are available in these 4 sizes



UPPER		XL	L	M	S
	A		70	67	64
B		79	78	70	73

All Dimension are in mm



LOWER		XL	L	M	S
	A		64	64	60
B		86	70	73	70

All Dimension are in mm

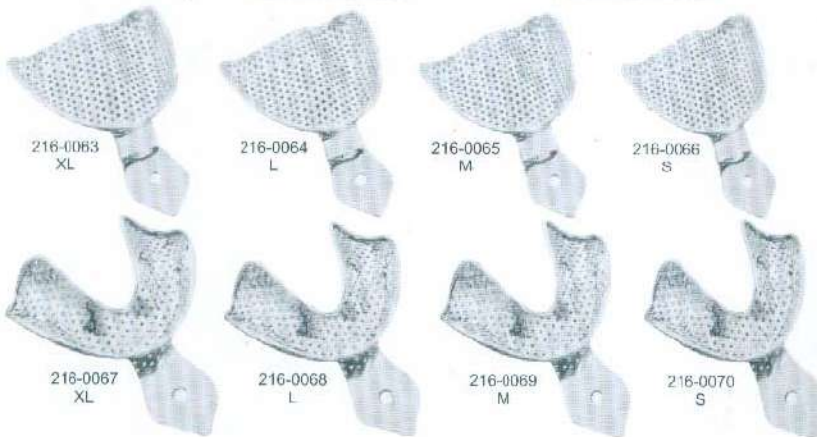

Available in Set of 8  
Code # Set - A008

Web: [www.mabsonortho.com](http://www.mabsonortho.com)

Tel: +92 52 3570603  
Fax: +92 52 3570604  
Moh. Islamabad Union Council  
Near Imran Market Ugoki Morre,  
Sialkot-51310 Pakistan.



MABSON ORTHO

# MABSON INDUSTRY

Manufacturer & Exporter of Surgical, Dental & Orthopedic Instruments

## Impression Trays

Available in Set of 8  
Code # Set - A009

For crown & bridgework Impression Trays

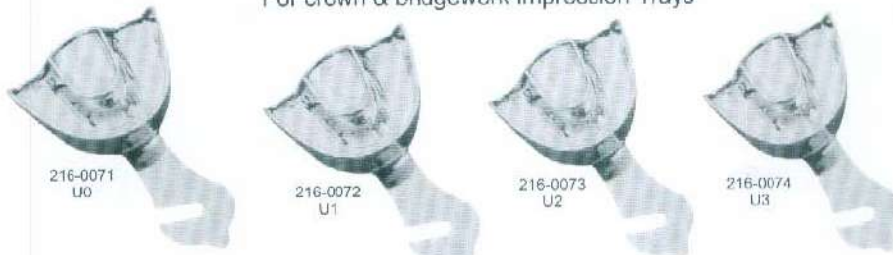

216-0071  
U0

216-0072  
U1

216-0073  
U2

216-0074  
U3

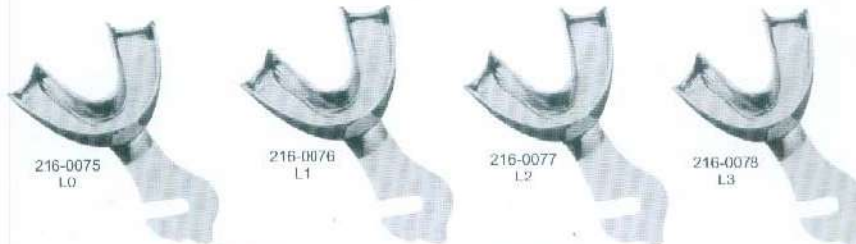

216-0075  
L0

216-0076  
L1

216-0077  
L2

216-0078  
L3

Upper Sizes 0,1,2,3.  
Depth of the tray 19.9 mm  
Height of palate 12.5 mm

Lower Sizes 0,1,2,3.  
Depth of the tray 12.9 mm

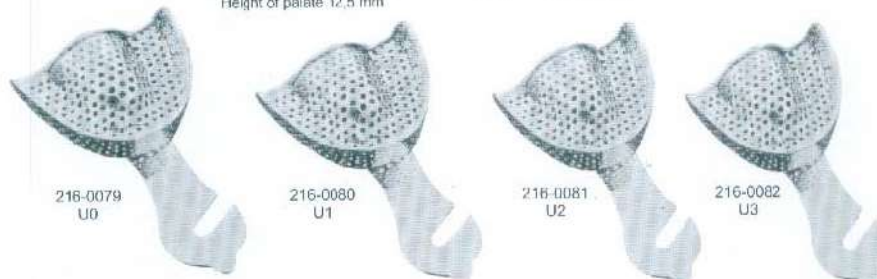

216-0079  
U0

216-0080  
U1

216-0081  
U2

216-0082  
U3



216-0083  
L0

216-0084  
L1

216-0085  
L2

216-0086  
L3

Available in Set of 8  
Code # Set - A010

Web: [www.mabsonortho.com](http://www.mabsonortho.com)

Tel: +92 52 3570603  
Fax: +92 52 3570604  
Moh. Islamabad Union Council  
Near Imran Market Ugoki Morre,  
Sialkot-51310 Pakistan.



MABSON ORTHO

# MABSON INDUSTRY

Manufacturer & Exporter of Surgical, Dental & Orthopedic Instruments

## Impression Trays

Impression trays for crown & bridge work



216-0087  
U1P



Solid

216-0088  
L1P



216-0089  
U1P



Perforated

216-0090  
L1P

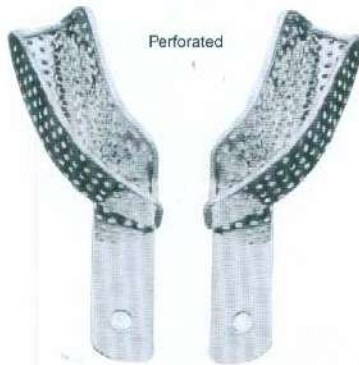

Perforated

216-0091  
For upper right jaw  
For lower left jaw

216-0092  
For upper left jaw  
For lower right jaw



216-0093  
Adjustable  
Perforated



216-0094  
Adjustable  
Solid

Available in 4 Sizes  
1.....44 mm  
2.....55 mm  
3.....60 mm  
4.....65 mm

Also available in Solid pattern

Web: [www.mabsonortho.com](http://www.mabsonortho.com)

Tel: +92 52 3570603  
Fax: +92 52 3570604  
Moh. Islamabad Union Council  
Near Imran Market Ugoki Morre,  
Sialkot-51310 Pakistan.





MABSON ORTHO

# MABSON INDUSTRY

Manufacturer & Exporter of Surgical, Dental & Orthopedic Instruments

Articulator



219-0001



219-0002



219-0003

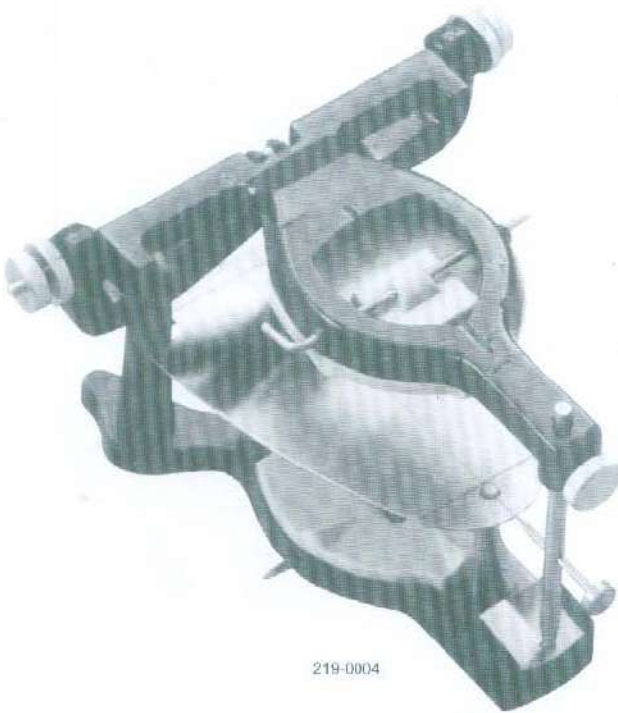

219-0004



219-0005



219-0006

Web: [www.mabsonortho.com](http://www.mabsonortho.com)

Tel: +92 52 3570603  
Fax: +92 52 3570604  
Moh. Islamabad Union Council  
Near Imran Market Ugoki Morre,  
Sialkot-51310 Pakistan.



MABSON ORTHO

# MABSON INDUSTRY

Manufacturer & Exporter of Surgical, Dental & Orthopedic Instruments

## Impression Trays Sets



220-0001



220-0002



220-0003

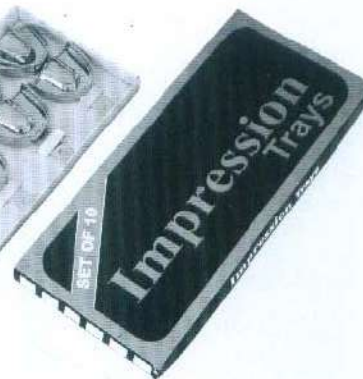

Web: [www.mabsonortho.com](http://www.mabsonortho.com)

Tel: +92 52 3570603  
Fax: +92 52 3570604  
Moh. Islamabad Union Council  
Near Imran Market Ugoki Morre,  
Sialkot-51310 Pakistan.



MABSON ORTHO

# MABSON INDUSTRY

Manufacturer & Exporter of Surgical, Dental & Orthopedic Instruments

## Hollow Ware Items

- |          | Ø   | Depth |
|----------|-----|-------|
| 217-0027 | 2"  | 2"    |
| 217-0028 | 4"  | 2"    |
| 217-0029 | 5½" | 2½"   |
| 217-0030 | 6"  | 2½"   |
| 217-0031 | 7"  | 3½"   |
| 217-0032 | 8"  | 3½"   |
| 217-0033 | 10" | 4"    |



Lotion Bowl

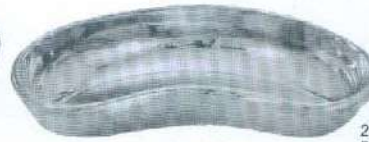

Kidney Trays

- 217-0034 6"
- 217-0035 8"
- 217-0036 10"
- 217-0037 12"



- 217-0038 6" x 9"
- 217-0039 8" x 12"



- 217-0040 10" x 10"



217-0041 Cotton Holder



- 217-0042 80 x 35 mm
- 217-0043 125 x 60 mm

- 217-0046 25 x 80 mm
- 217-0047 30 x 100 mm
- 217-0048 75 x 173 mm
- 217-0049 100 x 200 mm



217-0044 Spirit Lamp



217-0045 Spirit Lamp



Forcep Jar



- 217-0050 5cm x 15cm
- 217-0051 5cm x 10cm

Web: [www.mabsonortho.com](http://www.mabsonortho.com)

Tel: +92 52 3570603  
 Fax: +92 52 3570604  
 Moh. Islamabad Union Council  
 Near Imran Market Ugoki Morre,  
 Sialkot-51310 Pakistan.



MABSON ORTHO

# MABSON INDUSTRY

Manufacturer & Exporter of Surgical, Dental & Orthopedic Instruments

## Rubber Dam Clamps

### Molar Clamps Winged



218-0001  
Fig. 30



218-0002  
Fig. 31



218-0003  
Fig. 51



218-0004  
Fig. 138



218-0005  
Fig. 139



218-0006  
Fig. 15



218-0007  
Fig. 18



218-0008  
Fig. 24



218-0009  
Fig. 25



218-0010  
Fig. 26



218-0011  
Fig. 28

### Bicuspid Clamps Winged



218-0012  
Fig. 206



218-0013  
Fig. 207



218-0014  
Fig. 208



218-0015  
Fig. 209



218-0016  
Fig. 22



218-0017  
Fig. 27



218-0018  
Fig. 29

### Molar Clamps Winged



218-0019  
Fig. 26A



218-0020  
Fig. 28A



218-0021  
Fig. 30A



218-0022  
Fig. 31A



218-0023  
Fig. 51A



218-0024  
Fig. 27



218-0025  
Fig. 29



218-0026  
Fig. 60

### Bicuspid Clamps Winged



218-0027  
Fig. 200



218-0028  
Fig. 201



218-0029  
Fig. 202



218-0030  
Fig. 203



218-0031  
Fig. 204



218-0032  
Fig. 205

### Labial Clamps Winged



218-0033  
Fig. 210



218-0034  
Fig. 211



218-0035  
Fig. 212

Web: [www.mabsonortho.com](http://www.mabsonortho.com)

Tel: +92 52 3570603  
Fax: +92 52 3570604  
Moh. Islamabad Union Council  
Near Imran Market Ugoki Morre,  
Sialkot-51310 Pakistan.



MABSON ORTHO

# MABSON INDUSTRY

Manufacturer & Exporter of Surgical, Dental & Orthopedic Instruments

## Instruments Trays

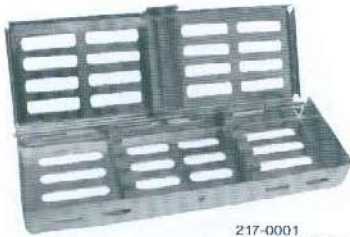

217-0001  
Scaler Sterilizing Tray  
For 5-pcs  
18 x 6 x 2 cm



217-0002  
Scaler Sterilizing Tray  
For 5-pcs  
18 x 8.5 x 2 cm



217-0003  
Scaler Sterilizing Tray  
For 10-pcs  
18 x 12.5 x 2 cm



217-0004  
Scaler Sterilizing Tray  
For 10-pcs  
18 x 14 x 2 cm

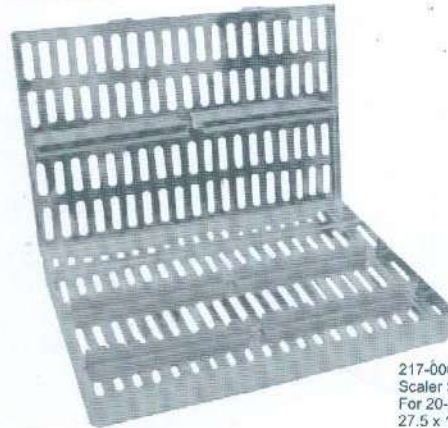

217-0005  
Scaler Sterilizing Tray  
For 20-pcs  
27.5 x 18 x 2.5 cm

Web: [www.mabsonortho.com](http://www.mabsonortho.com)

Tel: +92 52 3570603  
Fax: +92 52 3570604  
Moh. Islamabad Union Council  
Near Imran Market Ugoki Morre,  
Sialkot-51310 Pakistan.



MABSON ORTHO

# MABSON INDUSTRY

Manufacturer & Exporter of Surgical, Dental & Orthopedic Instruments

## Hollow Ware Items

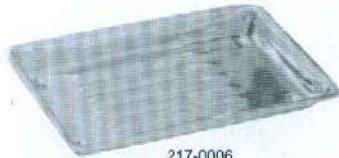

217-0006  
Scallers Tray

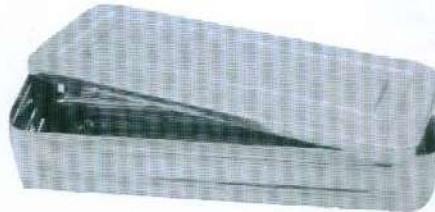

Instruments Box

217-0007  
10"×6"×2"  
217-0008  
12"×8"×2½"  
217-0009  
15"×12"×4"

217-0010  
8"×6"×2"  
217-0011  
10"×8"×2"  
217-0012  
12"×8"×2½"  
217-0013  
12"×10"×2½"  
217-0014  
14"×10"×2½"  
217-0015  
14"×12"×2½"



Instruments Tray with Lid



Instruments Tray without Lid

217-0016  
8"×6"×2"  
217-0017  
10"×8"×2"  
217-0018  
12"×8"×2½"  
217-0019  
12"×10"×2½"  
217-0020  
14"×10"×2½"  
217-0021  
14"×12"×2½"

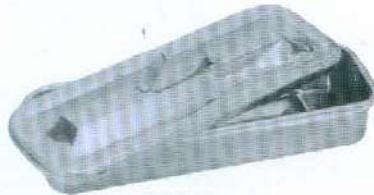

217-0022  
8"×3"×1½"  
Instruments Box



217-0023  
Endodontic box

217-0024  
10"×6"×2"  
217-0025  
12"×8"×2½"  
217-0026  
16"×12"×4"



Instruments Box

Web: [www.mabsonortho.com](http://www.mabsonortho.com)

Tel: +92 52 3570603  
Fax: +92 52 3570604  
Moh. Islamabad Union Council  
Near Imran Market Ugoki Morre,  
Sialkot-51310 Pakistan.



MABSON ORTHO

# MABSON INDUSTRY

Manufacturer & Exporter of Surgical, Dental & Orthopedic Instruments

## Impression Trays Set



220-0004



220-0005



220-0006

Web: [www.mabsonortho.com](http://www.mabsonortho.com)

Tel: +92 52 3570603  
Fax: +92 52 3570604  
Moh. Islamabad Union Council  
Near Imran Market Ugoki Morre,  
Sialkot-51310 Pakistan.



MABSON ORTHO

# MABSON INDUSTRY

Manufacturer & Exporter of Surgical, Dental & Orthopedic Instruments

## Instruments Packing



220-0007



220-0008



220-0009



220-0010



220-0011



220-0012



220-0013



220-0014



220-0015

Web: [www.mabsonortho.com](http://www.mabsonortho.com)

Tel: +92 52 3570603  
Fax: +92 52 3570604  
Moh. Islamabad Union Council  
Near Imran Market Ugoki Morre,  
Sialkot-51310 Pakistan.





MABSON ORTHO

# MABSON INDUSTRY

Manufacturer & Exporter of Surgical, Dental & Orthopedic Instruments

## Instruments Packing



220-0016

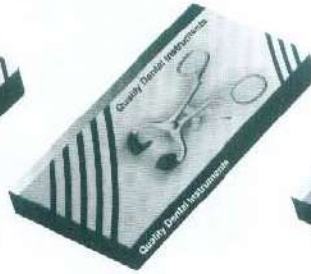

220-0017



220-0018



220-0019



220-0020

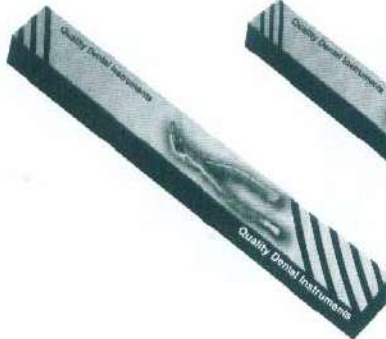

220-0021

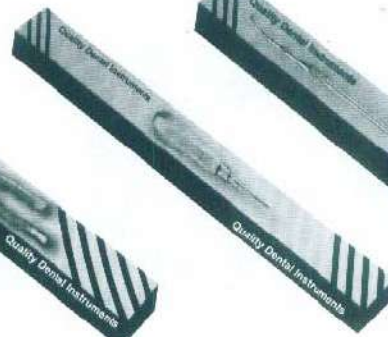

220-0022



220-0023

Web: [www.mabsonortho.com](http://www.mabsonortho.com)

Tel: +92 52 3570603  
Fax: +92 52 3570604  
Moh. Islamabad Union Council  
Near Imran Market Ugoki Morre,  
Sialkot-51310 Pakistan.